

**effepi**  
liquid shapes.

**effepi**  
liquid shapes.



**TRA PASSATO  
E PRESENTE:  
UNA STORIA  
CHE HA ORIGINI  
LONTANE**

**POISED BETWEEN  
PAST AND PRESENT:  
A STORY WHOSE  
ROOTS STRETCH  
FAR BACK IN TIME**

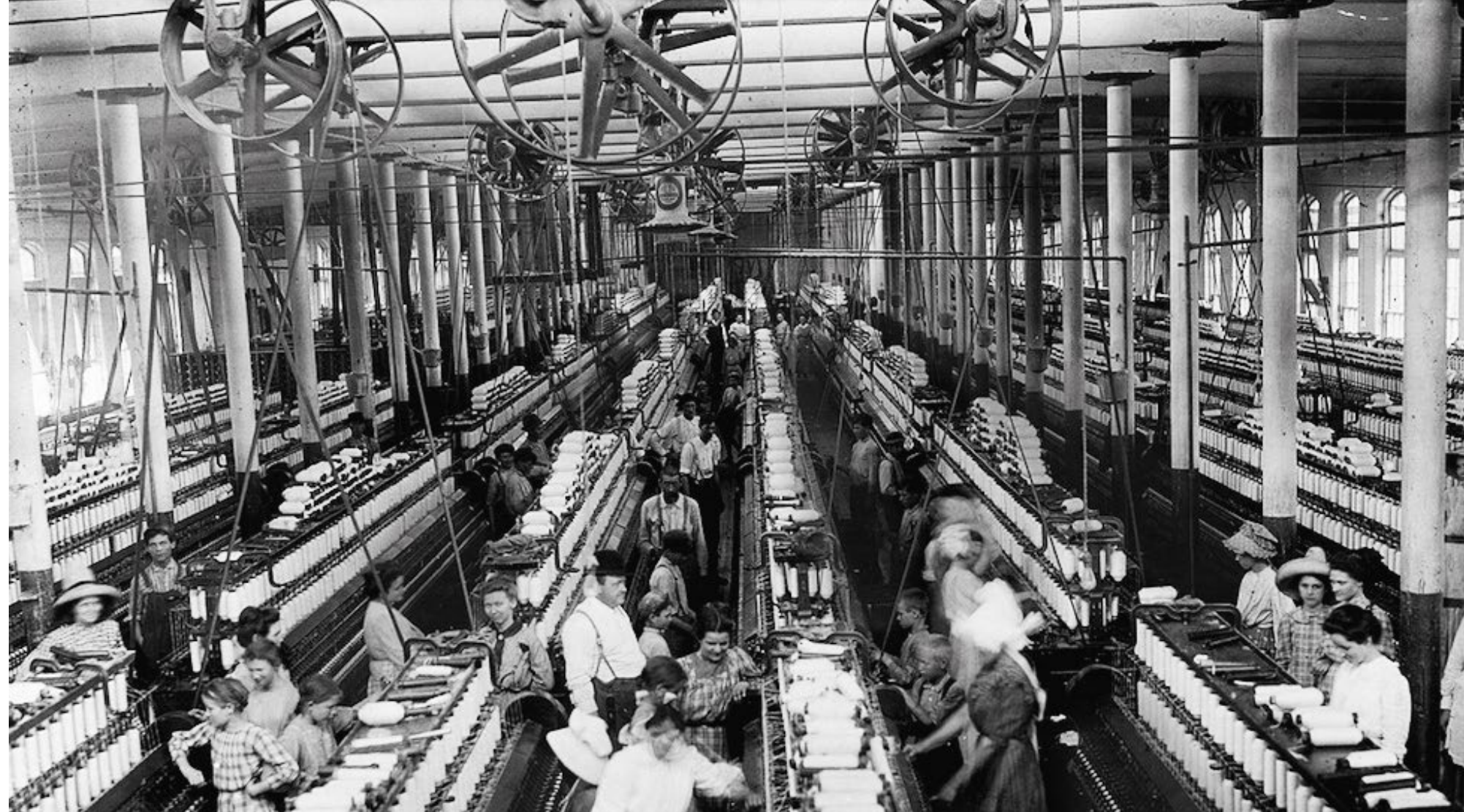

La storia di Effepi affonda le sue radici nella Lumezzane del dopoguerra, una zona dalla forte vocazione industriale, segnata da secoli di operosità e competenze altamente specializzate, in cui la cultura del lavoro ha da sempre una salda tradizione e dove l'uomo ha saputo trasformare l'industria in una possibilità di riscatto nei confronti di una natura poco generosa e, talvolta, aspra.

La ricerca costante di una qualità nuova, il desiderio delle aziende locali di essere motore degli avvenimenti, di mettersi al centro dell'azione per portare innovazione e prosperità, hanno trasformato questo territorio in un polo industriale e commerciale di riferimento in tutto il mondo, espressione di qualità e solidità indiscusse.

Effepi nasce nel cuore pulsante di questo distretto nell'anno 1949, fondata da Faustino Pintossi, che costituisce la prima società con i quattro figli maschi; la produzione viene portata avanti da questi ultimi, dopo la prematura scomparsa del padre.

Il fermento economico di quegli anni favorisce il consolidarsi di aziende collegate e gestite dalla famiglia, delocalizzando la fonderia a Tiarno in provincia di Trento e la produzione di sifoni e scarichi, prima a Casto in Vallesabbia e poi a Lodrino in Valtrompia.

Negli anni le sedi sono state unificate e conglobate nell'attuale stabilimento Effepi.

*The story of Effepi traces its roots back to the post-war period in the Lumezzane area, a highly industrialized district characterized by centuries of hard work and specialist skills, where the work culture has always played a primary role and where man has focused on developing industrial activities to compensate for a natural environment that is not particularly generous and often inhospitable.*

*A constant research into improved quality standards, the intent of local firms to be the driving force of events, to be at the centre of the action in order to achieve innovation and prosperity, have made this area an industrial and commercial pole that is acknowledged worldwide, an undisputed expression of quality and stability.*

*Effepi was founded in the heart of this district in 1949 by Faustino Pintossi, who started out in business with his four sons; manufacturing activities were managed by the latter, following the premature death of their father.*

*The economic boom of those years facilitated the consolidation of associated companies managed by the family, who relocated the foundry to Tiarno in Trento province and the production of siphons and drainage outlets initially to Casto in Vallesabbia and subsequently to Lodrino in Valtrompia.*

*In the course of the years, these production units were united and integrated in what is now the Effepi plant.*



Questo ha portato ad un conseguente e naturale ampliamento della sede che, negli anni '70, si è trasferita in Valtrompia a Villa Carcina - importante crocevia commerciale - nella vecchia sede del Cottonificio Bernocchi, costruito sul finire dell'Ottocento. All'interno della struttura si respira la storia economica del nostro Paese, mentre l'architettura richiama immediatamente il suo impiego originario, la filatura: in questo cottonificio, mattone dopo mattone, pietra dopo pietra, si sono avvicendate persone, storie, mani al lavoro. Ieri il cotone, oggi la rubinetteria.

Effepi proprio quest'anno sta effettuando un'imponente opera di ristrutturazione degli edifici: l'obiettivo è quello di dare nuova vita ad una struttura fortemente inserita nel territorio, punto di riferimento architettonico-industriale ed espressione dell'operosità e del legame alle proprie radici nella Valle.

Un perfetto connubio tra i prodotti di design dell'azienda ed il fascino dell'architettura industriale, il luogo perfetto all'interno del quale accogliere clienti e fornitori, trasportandoli in uno spazio di rilevanza storica.

Questo investimento consistente di tempo e risorse, è mosso dalla sensibilità della famiglia, da sempre impegnata localmente a livello sociale e culturale, ed è altresì sollecitata e ben accolta dalle istituzioni locali.

Oggi l'azienda è gestita da Fausto e Giovanni Pintossi, e dai figli di Fausto - Andrea e Lorenzo: il tramandarsi della produzione di generazione in generazione (oggi siamo alla IV), ha visto un evolversi continuo dell'azienda negli anni, con la produzione di rubinetterie di prestigio, vendute in tutto il mondo.

*This has led to a consequent and natural extension of the premises which, in the 70's, moved to Villa Carcina in Valtrompia - an important commercial hub - in what used to be the Cottonificio Bernocchi textile mill, built in the late 1800s. The building interiors reflect the economic history of our country, while the architectural elements immediately recall its original vocation, spinning: in this cotton mill, brick by brick, stone by stone, people, stories and workforces have succeeded each other. Yesterday, it was cotton, today it is tapware.*

*This year, in fact, Effepi is engaged in an important renovation project involving the buildings: the aim is to breathe new life into a structure that is deeply rooted in its territory, an architectural-industrial landmark which expresses industriousness and the bond with its valley roots. A perfect marriage between the company's design products and the charm of industrial architecture, the ideal place in which to welcome customers and suppliers, and enable them to savour a building of historical importance.*

*This considerable investment of time and resources is driven by the awareness of the family, whose members have always been engaged locally in social and cultural ambits, encouraged and appreciated by the local institutional bodies.*

*Each company is run by Fausto and Giovanni Pintossi, and by Fausto's sons - Andrea and Lorenzo: this handing down of production from one generation to the next (this is the 4th), has gone hand in hand with a constant evolution of the company in the course of the years, with the production of prestigious tapware, distributed worldwide.*

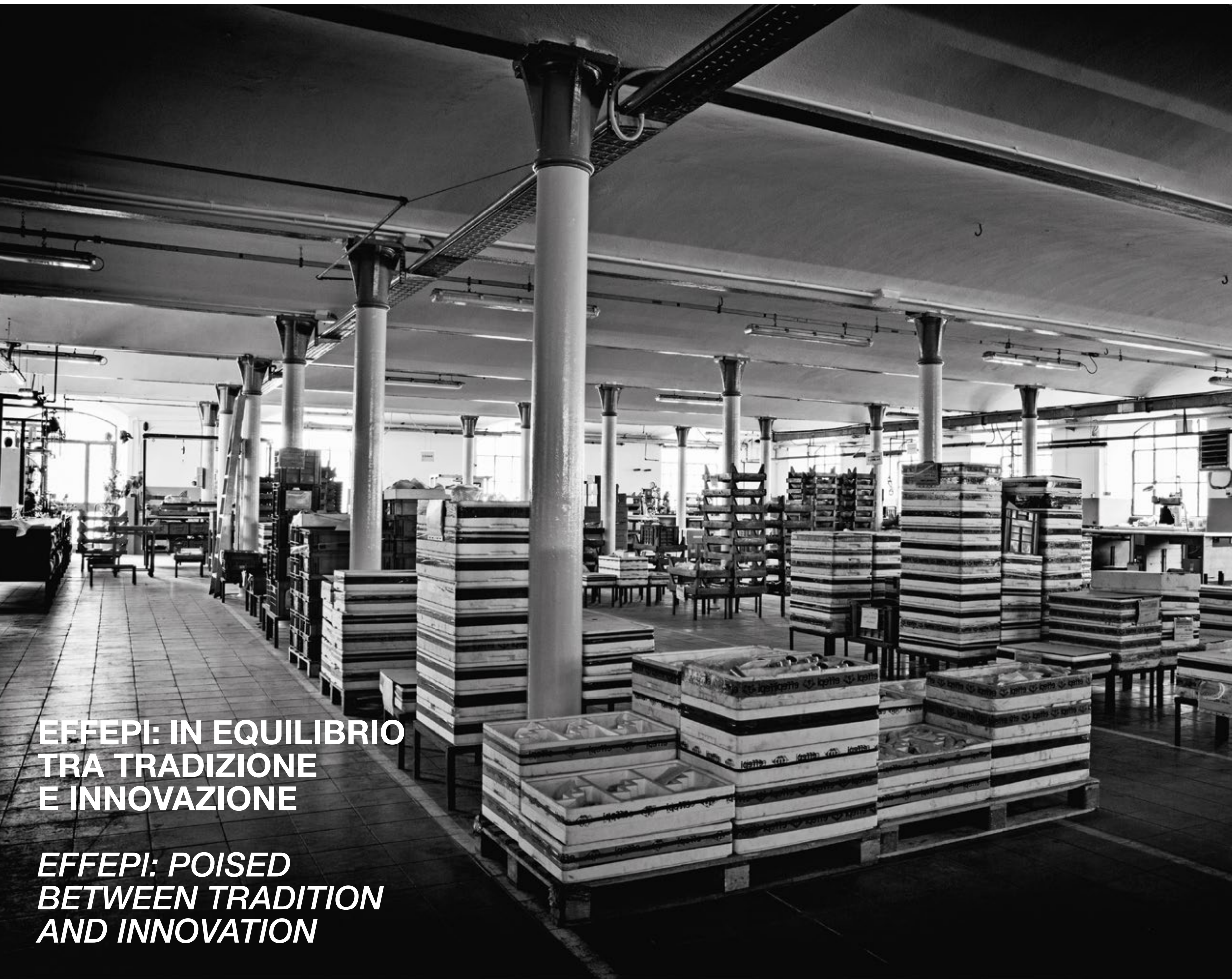

**EFFEPI: IN EQUILIBRIO  
TRA TRADIZIONE  
E INNOVAZIONE**

**EFFEPI: POISED  
BETWEEN TRADITION  
AND INNOVATION**

Una sede storica che è fucina di un incredibile fermento innovativo: il design è il presupposto che muove ogni azione in azienda, la ricerca costante di forme nuove e dettagli ricercati è alla base di ogni progetto. Innovare vuol dire sperimentare, significa andare al di là della tecnica, in una fusione tra estetica ed affidabilità del prodotto: ogni rubinetto firmato Effepi è un pezzo funzionale ed allo stesso tempo non convenzionale.

Un equilibrio costante tra tradizione ed innovazione permette di realizzare prodotti perfettamente calati nel contesto contemporaneo, in grado di trasformare l'ambiente bagno in una stanza in cui benessere ed emozioni sono il risultato dell'armonia delle forme, in una perfetta combinazione tra funzione ed estetica.

*An historical location that acts as a breeding ground for an incredible innovative ferment: design is the driving force behind everything the company does, with on-going research into new formal solutions and refined details underlying every project. Innovation is tantamount to experimentation, it means going beyond technology, in a fusion between aesthetic content and product reliability: each tap signed by Effepi is a functional object defying conventional precepts.*

*A constant balance between tradition and innovation enables the creation of products that find their perfect setting in a contemporary context, and are able to make the bathroom an environment in which wellbeing and emotions spring from formal harmony, in a perfect fusion of function and aesthetics.*





La nostra è una storia che viene da lontano e che è da sempre caratterizzata da un caposaldo imprescindibile: la ricerca dell'eleganza. Le nostre collezioni sono frutto di studio e osservazione del passato, per consegnare nel presente prodotti dal design senza tempo. Avere nella propria casa un prodotto Effepi significa sposare il gusto del bello, il fascino di un oggetto di cui non ci si stanca mai.

*Ours is a story that comes from afar and has always been characterized by an indispensable cornerstone: the strive for elegance. Our collections are fruit of research and an attentive observation of the past, aimed at offering timeless design products to contemporary users. The possession of an Effepi product is tantamount to marrying a taste for beauty, the charm of an object that never tires.*



**L'ELEGANZA È SENZA TEMPO**  
**ELEGANCE IS TIMELESS**



**A VOLTE,  
SEMPLICEMENTE,  
SONO LE  
PERSONE A FARE  
LA DIFFERENZA**

**SOMETIMES,  
IT IS SIMPLY THE  
PEOPLE WHO MAKE  
THE DIFFERENCE**

A fare la differenza è il lavoro di squadra, sono le persone. La certezza di avere alle spalle un gruppo solido e preparato, dove le competenze dei singoli trovano armonia e completezza, trasforma Effepi in un'azienda competitiva sul piano nazionale e internazionale. In ogni rubinetto è racchiuso il potenziale dei nostri operai, dei tecnici, dei designers, di ogni singolo impiegato. L'amore per le cose semplici, la concretezza e la cura dei dettagli sono i presupposti indispensabili che muovono il lavoro in azienda con un preciso obiettivo: soddisfare le esigenze dei clienti con risposte chiare e precise, con una coerenza che riflette la nostra essenza.

*What makes the difference in any teamwork, are the people. The certainty of being backed up by a well-knit and expert group of people, in which the skills of each individual find harmony and fulfilment, makes Effepi a competitive company on the domestic and international markets. Each tap encapsulates the potential of our workers, technicians, designers and each and every employee. The love of simple things, pragmatism and attention to detail are the essential requisites driving our company's activities towards a precise objective: to satisfy customer needs with accurate and well-defined solutions, with a consistent approach that reflects the way we are.*



WE ARE  
WHAT  
WE SAY  
WE ARE

# BEEFFEPI

Famiglia, storia, passione: i nostri prodotti rispecchiano la nostra filosofia, in cui forma e sostanza sono due facce della stessa medaglia.

**Noi siamo ciò che diciamo di essere. Sempre.**

*Family, history, enthusiasm: our products reflect our philosophy, in which form and substance are two sides of the same coin.*

***We are what we say we are. Always.***

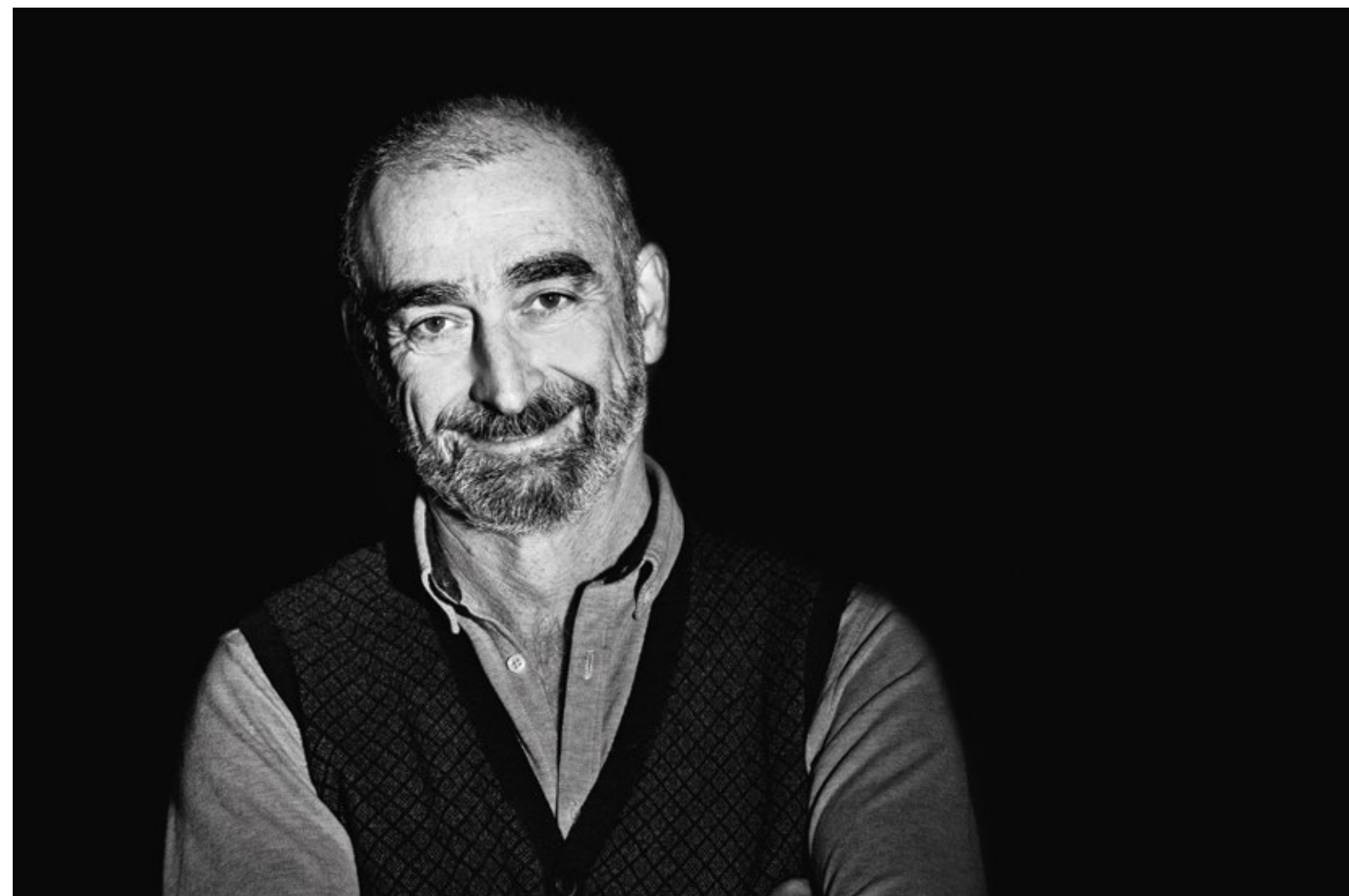





**PASSIONE & ARTIGIANALITÀ**  
**PASSION & CRAFTSMANSHIP**



Ogni prodotto Effepi è pensato per diventare un oggetto d'arredo, bello e funzionale allo stesso tempo. I nostri rubinetti sono concepiti come pezzi dallo stile sempre contemporaneo, in grado di arredare il bagno e la cucina, secondo le esigenze ed i sogni del cliente, pensati su misura per soddisfare le singole necessità. La cura dei dettagli non si esprime solo attraverso la ricerca sul prodotto, ma anche con il servizio garantito al cliente.

Effepi è sinonimo di una qualità mai scontata, di una serietà che affonda le sue radici nella storicità, di una precisione voluta e ricercata, per offrire al cliente proprio il prodotto che stava cercando.

*Every Effepi product is designed to become a decorative object that is both beautiful and functional. Our taps are conceived as pieces which consistently express a contemporary style and effectively furnish bathrooms and kitchens according to our customers' requirements and aspirations, designed to provide tailor-made solutions to specific needs. This meticulous attention to detail is not only expressed through product research, but also defines the service we provide to customers. Effepi is synonymous with a quality that is never taken for granted, with a professionalism rooted in the past and an accuracy that leaves nothing to chance, enabling us to provide our customers with the products they seek.*



In Effepi tradizione e ricerca tecnologica, industrializzazione e artigianalità, sono distinzioni che si fondono sapientemente; la storia ci ha portato ad armonizzare questi apparenti contrasti, per trasformarli in connubi perfetti. I nostri prodotti sono il risultato di anni di esperienza sul campo, costante attenzione per l'innovazione stilistica e funzionalità. Il nostro è un lavoro che si tramanda di padre in figlio, un testimone che da generazioni ci trasmettiamo, con dedizione e passione.

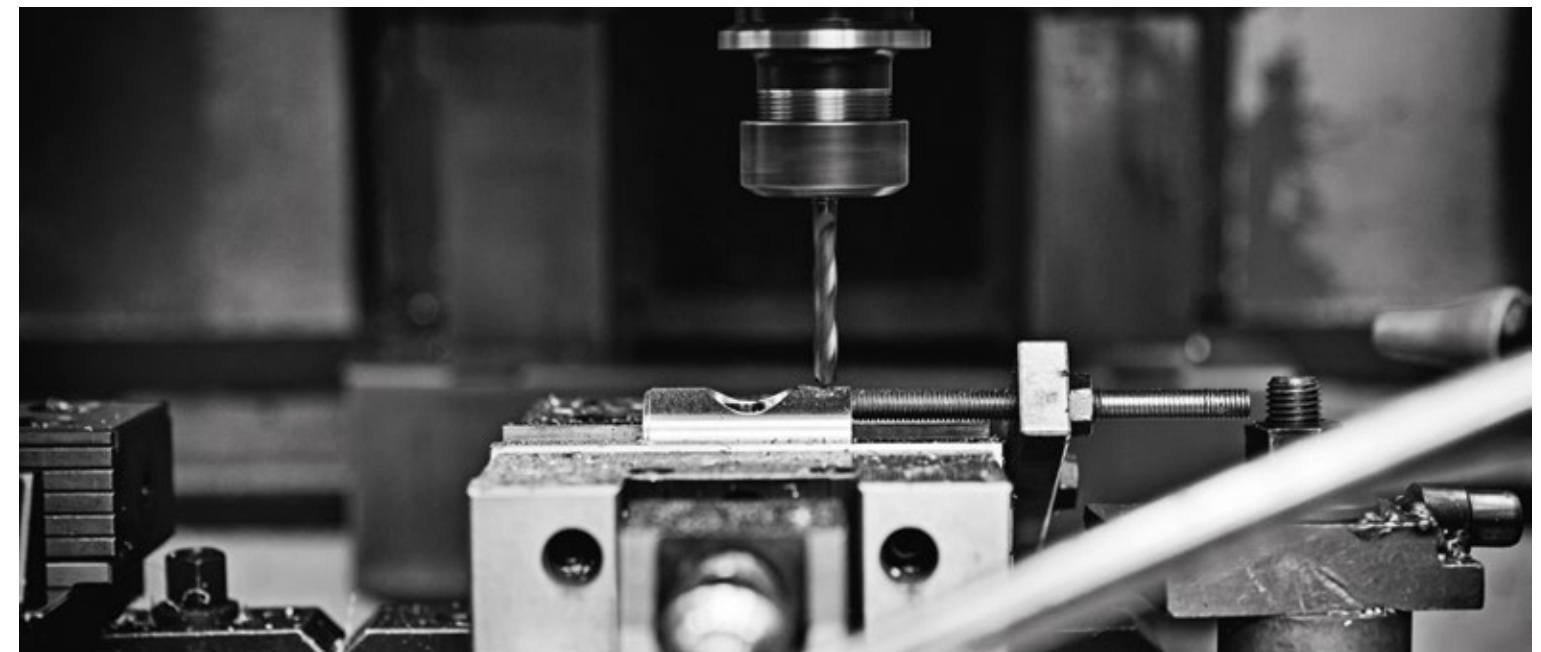

*At Effepi, tradition and technological research, industrial production and craftsmanship, are artfully blended distinctions; our history has led us to harmonize these apparently contrasting elements to transform them into perfect combos. Our products stem from years of experience in the field, together with an unfailing attention to stylistic innovation and functionality. Ours is an activity that has been passed down from father to son; we have passed on the baton for generations, with dedication and passion.*



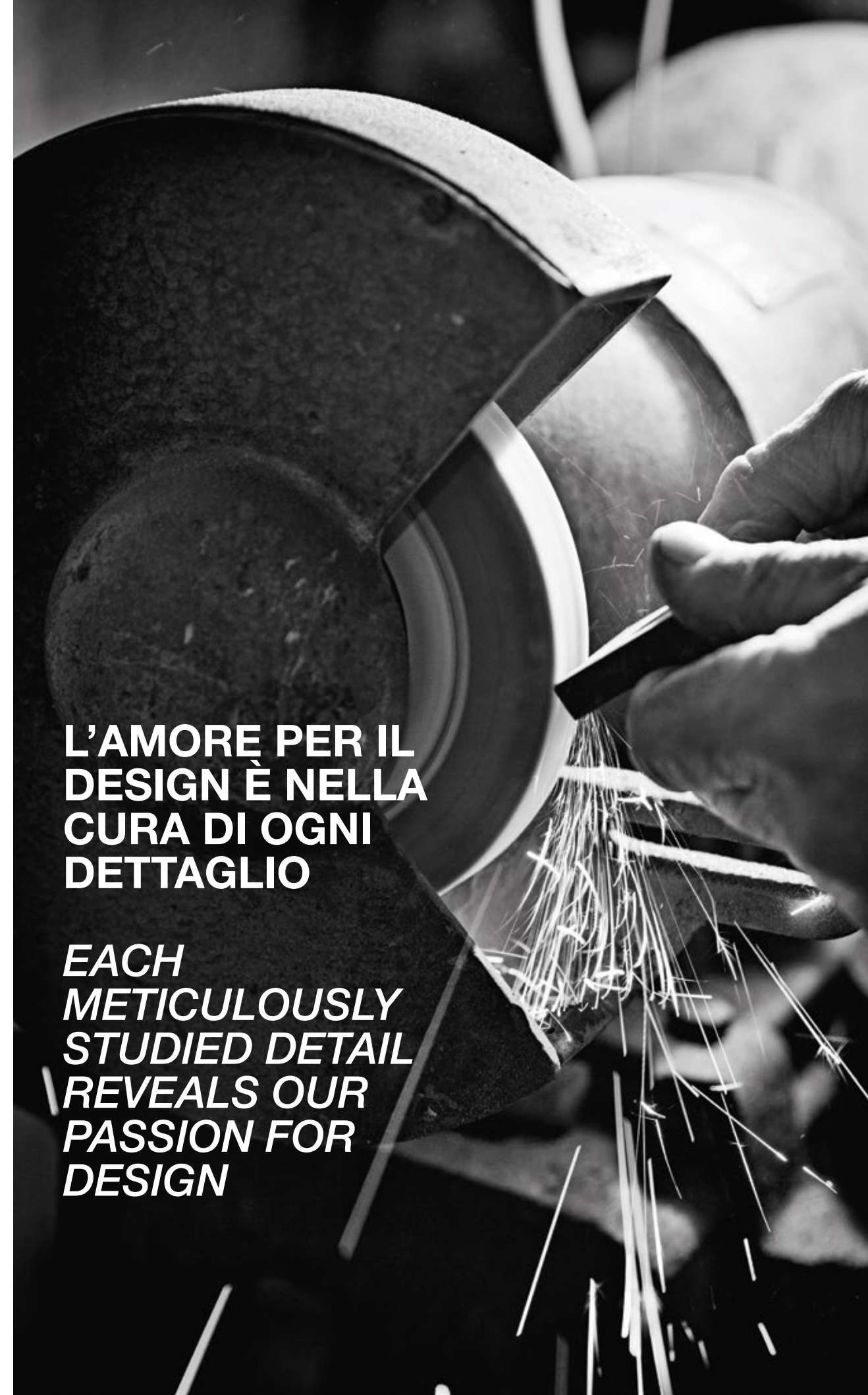

**L'AMORE PER IL  
DESIGN È NELLA  
CURA DI OGNI  
DETTAGLIO**

**EACH  
METICULOUSLY  
STUDIED DETAIL  
REVEALS OUR  
PASSION FOR  
DESIGN**

## REALIZZATO SU MISURA

Linee armoniose e forme sinuose: l'amore per il design è ciò che da sempre ci contraddistingue. Ogni prodotto Effepi è pensato per diventare un oggetto d'arredo, bello e funzionale allo stesso tempo.

I nostri rubinetti sono concepiti come pezzi dallo stile sempre contemporaneo, in grado di arredare il bagno e la cucina secondo le esigenze e i sogni del cliente, pensati su misura per soddisfare le singole necessità. La cura dei dettagli non si esprime solo attraverso la ricerca sul prodotto, ma anche attraverso il servizio offerto al cliente. Effepi è sinonimo di puntualità, affidabilità e serietà.

*Harmonious lines and sinuous shapes: love of design is what has always distinguished us. Each Effepi product is designed to become a piece of furniture, beautiful and functional at the same time.*

## MADE TO MEASURE

*Our taps are conceived as pieces of contemporary style, able to furnish the bathroom and kitchen according to the needs and dreams of the customer, tailor-made to meet individual needs. The attention to detail is expressed not only through product research, but also through the service offered to the customer. Effepi stands for punctuality, reliability and seriousness.*





**IL DESIGN HA A CHE FARE  
CON IL RENDERE LE PERSONE  
FELICI A LIVELLO FUNZIONALE,  
ESTETICO ED EMOZIONALE.**

***DESIGN HAS TO DO WITH MAKING  
PEOPLE HAPPY ON A FUNCTIONAL,  
AESTHETIC AND EMOTIONAL LEVEL.***

# LE NOSTRE FINITURE OUR FINISHES



**CROMO NERO**  
BLACK CHROME



**NERO OPACO**  
MATT BLACK



**NERO SATINATO**  
SATIN BLACK

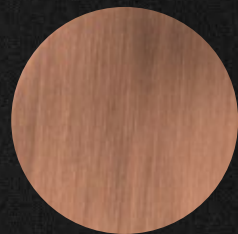

**RAMATO**  
COPPER



**RAMATO OPACO**  
MATT COPPER



**NICHEL LUCIDO**  
POLISHED NICKEL



**NICHEL SATINATO**  
SATIN NICKEL



**NICHEL FOSFORO**  
NICKEL PHOSPHORUS



**ORO LUCIDO**  
POLISHED GOLD



**ORO OPACO**  
MATT GOLD

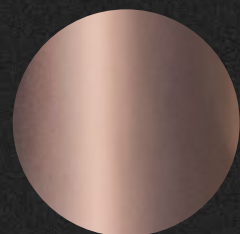

**ORO ROSA**  
ROSE GOLD



**BRONZATO**  
BRONZE



**BRONZATO OPACO**  
MATT BRONZE



**OTTONE LUCIDO**  
POLISHED BRASS



**OTTONE OPACO**  
MATT BRASS

## SOLO SU LAVELLI CUCINA ONLY ON KITCHEN TAPS

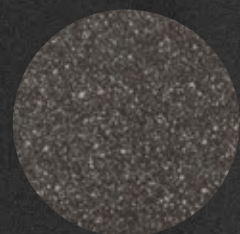

**FRAGRANITE  
ARDESIA**  
SLATE GRANITE



**FRAGRANITE  
BIANCO**  
WHITE GRANITE

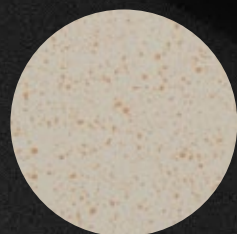

**FRAGRANITE  
AVENA**  
OAT GRANITE



**TERRA DI  
FRANCIA**  
EARTH OF FRANCE



**NUOVO CATALOGO,  
NUOVA ISPIRAZIONE.**

**NEW CATALOGUE,  
NEW INSPIRATION.**

L'approccio originale in questo nuovo catalogo porta ad una svolta concreta al nostro modo di presentarci sul mercato: il design diventa protagonista assoluto di un percorso ancora in divenire, in cui l'eleganza e la qualità dei materiali trovano nuova vita all'interno delle nostre produzioni.

Un nuovo modo di comunicare, in cui la sostanza, ormai assodata, dei nostri articoli è stimolo creativo, volto al continuo miglioramento. L'immagine diventa una dichiarazione d'amore verso i nostri prodotti, collocati all'interno di uno spazio autentico, tutto da costruire.

Un catalogo essenziale, che si ispira al mondo del cinema e trae suggestioni dalle scene del film Dogville di Lars von Trier: ambientazioni pulite e minimali, in cui i prodotti - così come gli attori nel film - vengono valorizzati ed enfatizzati a discapito del superfluo, emergendo in un set spogliato da elementi di corredo. Solo ciò che conta viene evidenziato, in un contrasto tra antico e moderno, tra semplicità e design, volto a valorizzare le nostre collezioni.

Un catalogo emozionale, semplice da consultare ed in grado di stupire ad ogni pagina, concepito per permettere a chi lo sfoglia di sentirsi vero protagonista accanto ai rubinetti.

*The original approach adopted by this new catalogue leads to a turning point in the way we address the market: design plays the leading role in an ever evolving experience, in which elegance and quality materials find a new form of expression in our collections.*

*A new mode of communication, in which the proven value of our articles provides the creative inspiration for an on-going process of improvement. Image becomes a declaration of love addressed to our products, which are showcased in an authentic space waiting to be created.*

*A sleek catalogue, inspired by the cinema world, with references to scenes from the film 'Dogville' by Lars von Trier: pared-down, minimalist interiors in which the products - similarly to the protagonists of the film - are valorised and highlighted by a total absence of frills, the stand-out elements of a set devoid of decorative elements. Only what counts is evidenced, in a contrast between ancient and modern, between simplicity and design, aimed at showcasing our collections in the best possible light.*

*An emotion-packed catalogue, simple to consult and sure to amaze at each new page, conceived to enable the browser to feel like an authentic protagonist alongside our taps.*

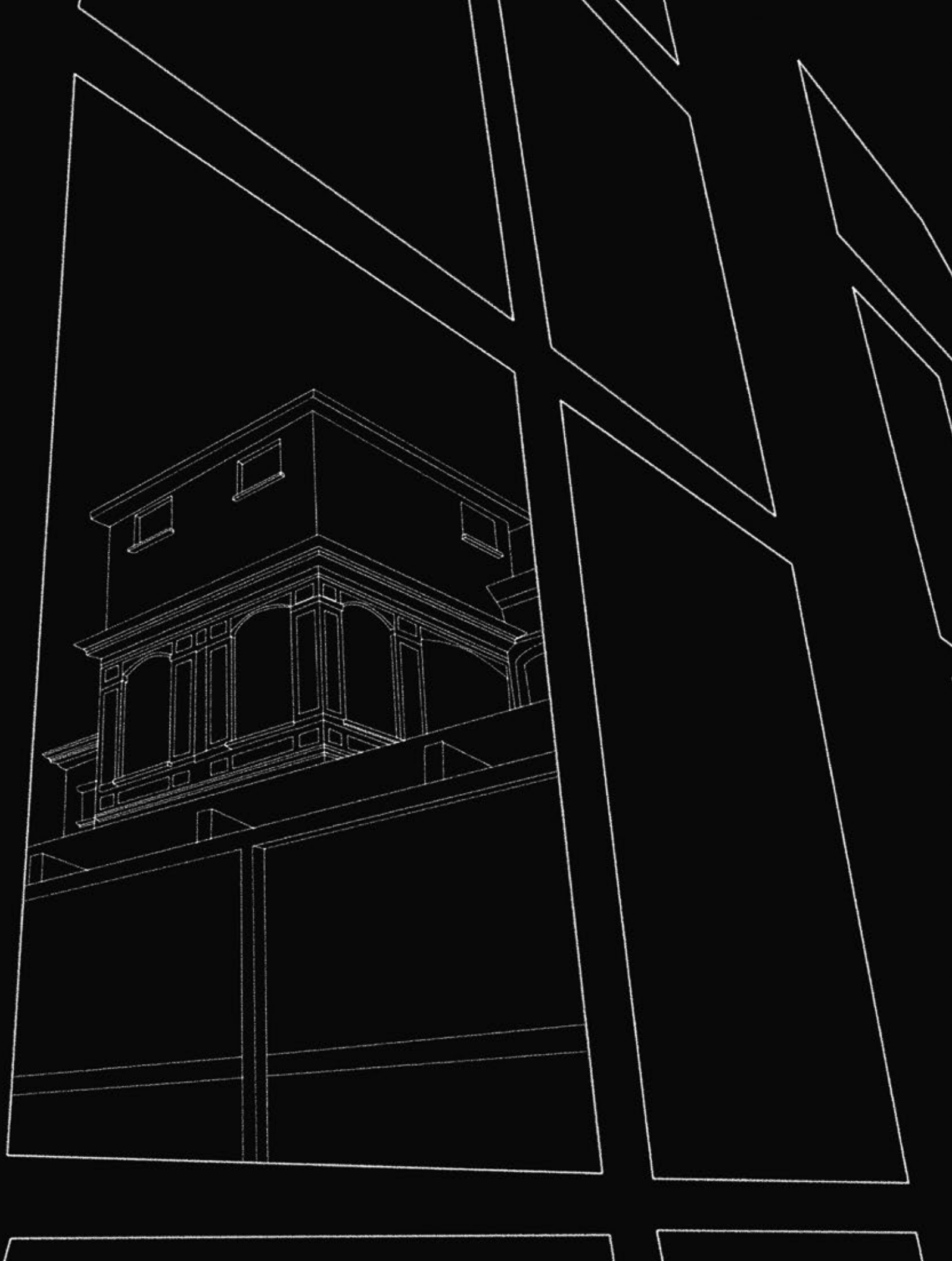

“

**STILE  
CONTEMPORANEO**

”

“

***CONTEMPORARY  
STYLE***

”



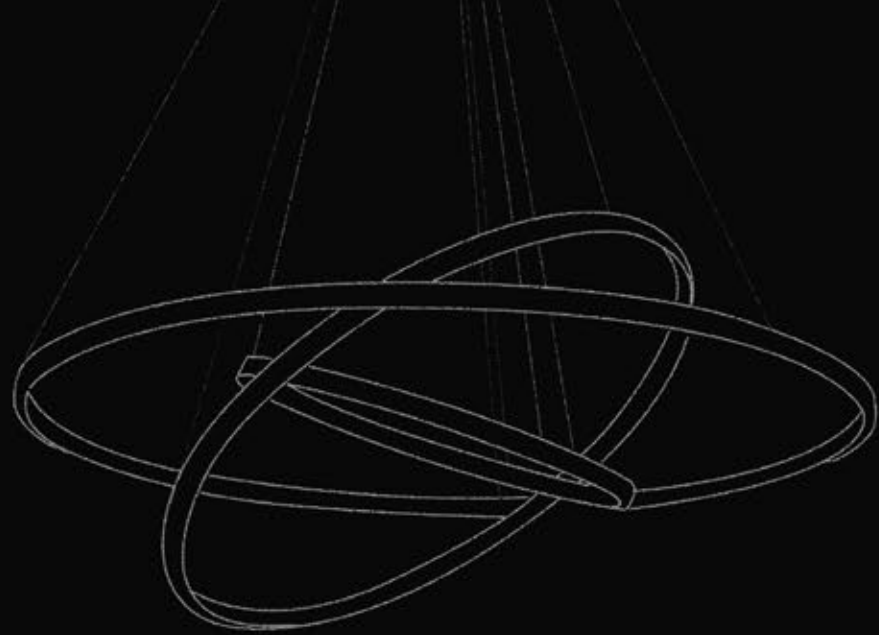

THOR



ART. 9032

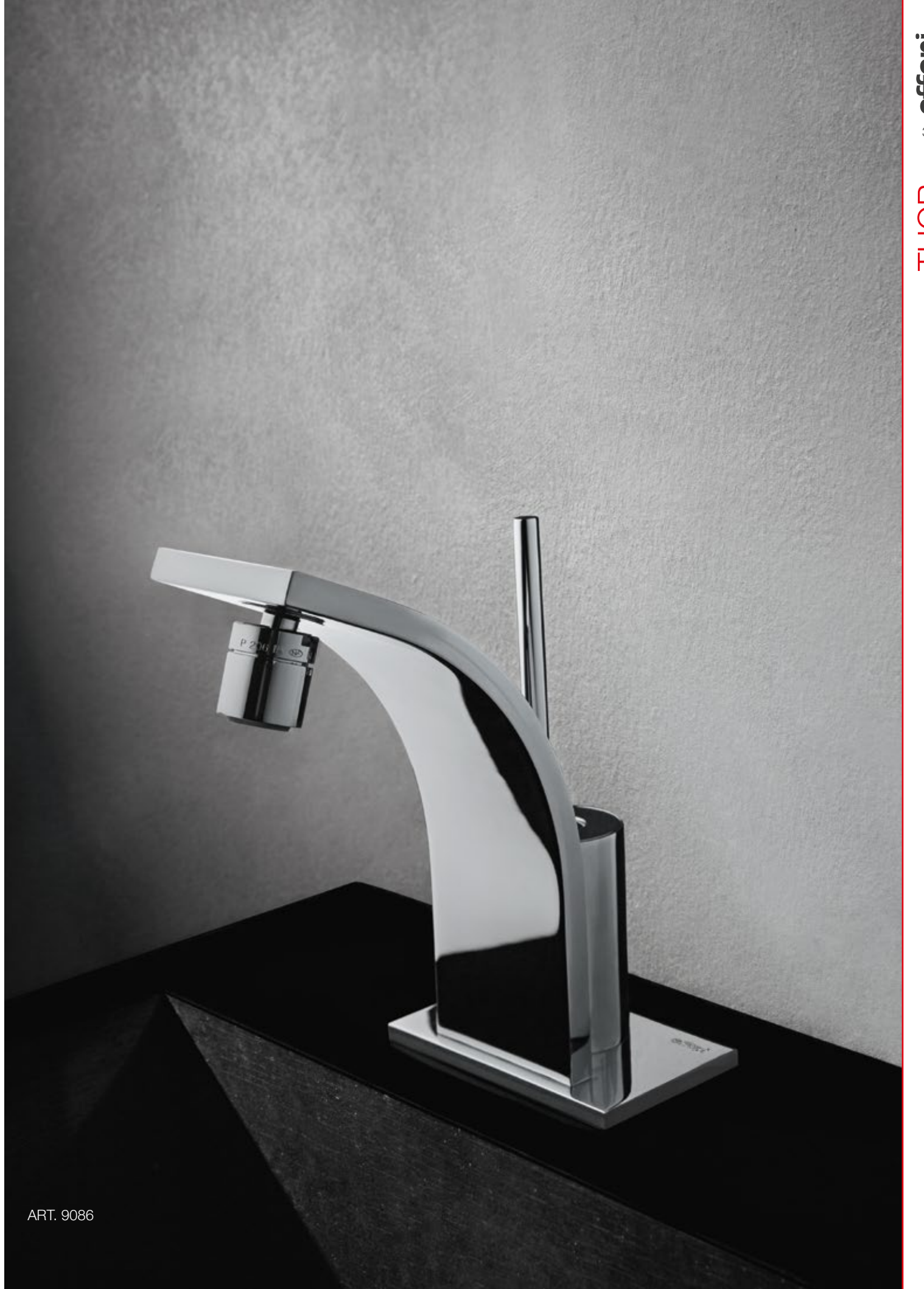

ART. 9086



ART. 9031



ART. 9007



ART. 9006



ART. 9187 + ART. 186-C5



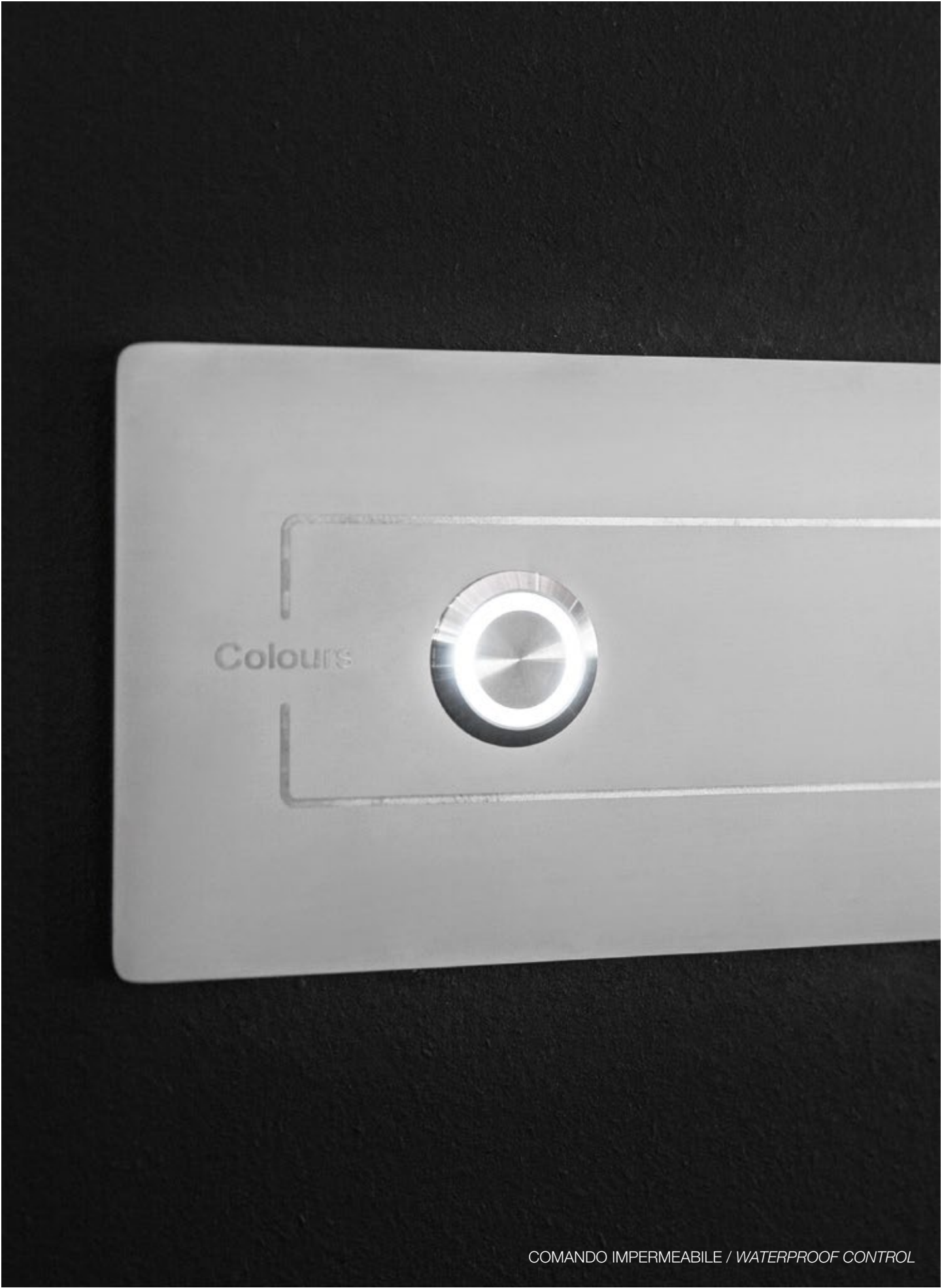

COMANDO IMPERMEABILE / WATERPROOF CONTROL

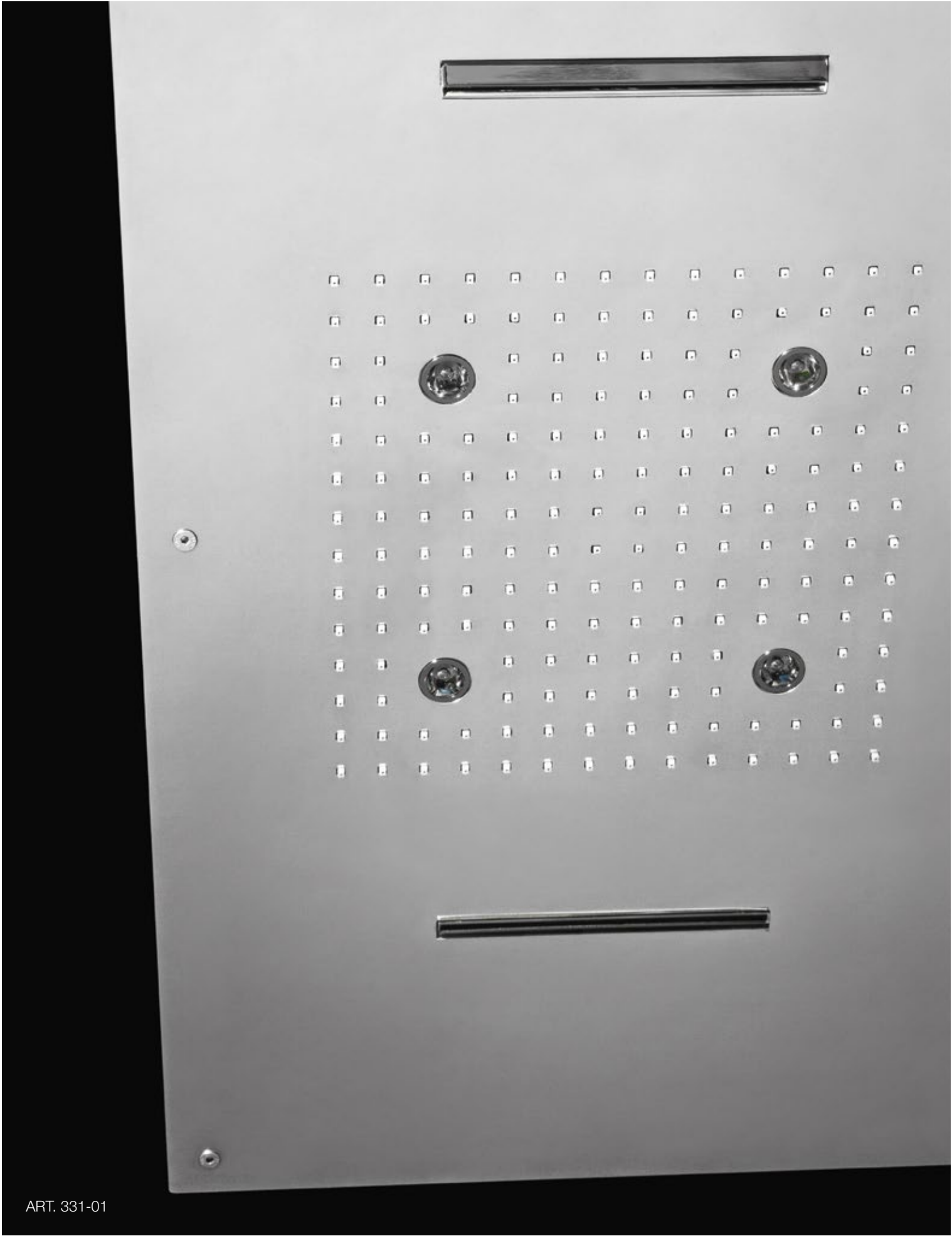

ART. 331-01



LAVABO / BIDET  
WASHBASIN / BIDET

**9154**

Colonna lavabo a pavimento **completa di Techno-Box**  
*Floor basin column single lever mixer with Techno-Box*  
• 1,1748

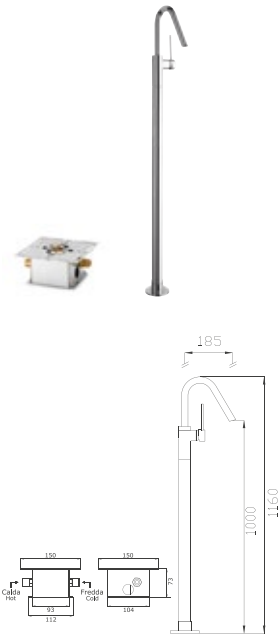

**9032**

Monocomando lavabo con scarico  
*Basin single lever mixer with pop-up waste*  
• 0,5221

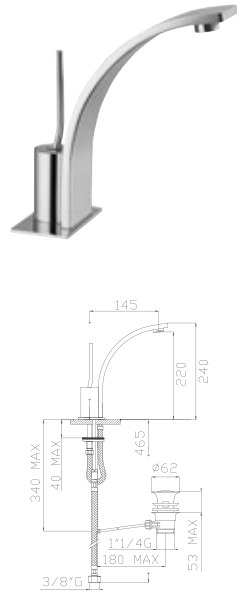

**9086**

Monocomando bidet con scarico  
*Bidet single lever mixer with pop-up waste*  
• 0,5221

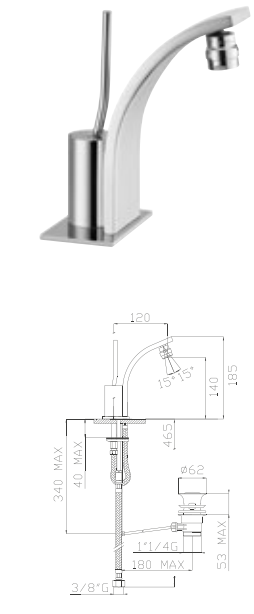

**9030**

Monocomando lavabo senza scarico  
*Basin single lever mixer without pop-up waste*  
• 0,5062

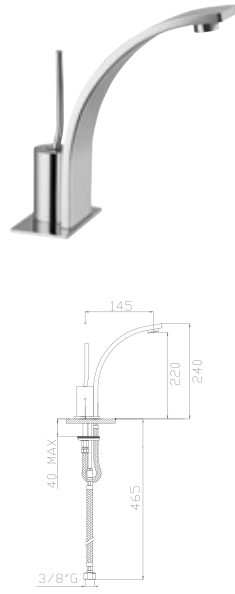

**9031**

Monocomando lavabo due fori senza scarico  
*Two-hole basin single lever mixer without pop-up waste*  
• 0,5698

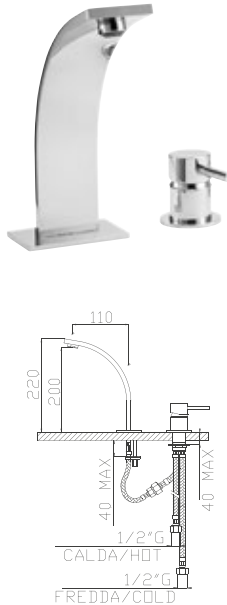

**9034**

Monocomando lavabo ad incasso **completo di Easy-Box**  
*Concealed basin single lever mixer with Easy-Box*  
• 0,7827

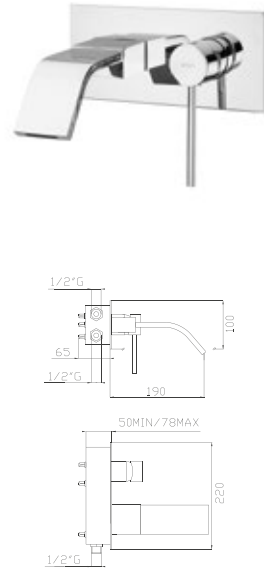

DOCCIA  
SHOWER

ADATTABILE AL SISTEMA **UNI-BOX**  
PER DETTAGLI VEDERE LISTINO PREZZI  
SUITABLE FOR **UNI-BOX SYSTEM**  
FOR FURTHER DETAILS SEE THE PRICE-LIST



**9186**

Monocomando doccia incasso quattro uscite **non adattabile al sistema Uni-Box**  
*Four way concealed shower single lever mixer not suitable for Uni-Box system*  
• 0,4947

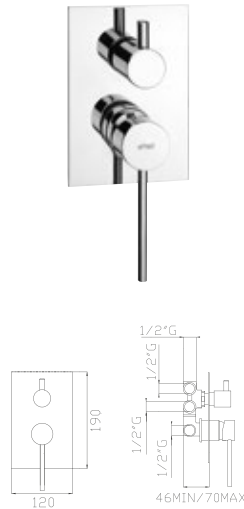

**9187**

Monocomando doccia incasso tre uscite  
*Three-way concealed shower single lever mixer*  
• 0,4947



**9287**

Miscelatore termostatico doccia incasso tre uscite  
*Three-way concealed shower thermostatic mixer*  
• 0,7085

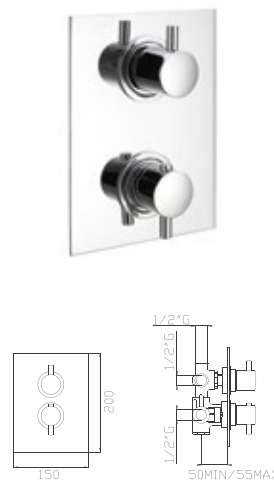

**9188**

Monocomando doccia incasso due uscite **con deviatore a pulsante**  
*Two-way concealed shower single lever mixer with push diverter*  
• 0,4126

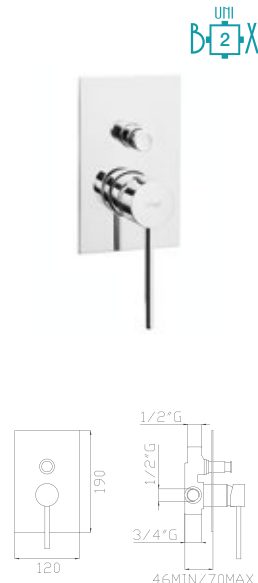

**9288**

Miscelatore termostatico doccia incasso due uscite  
*Two-way concealed shower thermostatic mixer*  
• 0,6873



**9189**

Monocomando doccia incasso  
*Concealed shower single lever mixer*  
• 0,2818



**9289**

Miscelatore termostatico doccia incasso  
*Concealed shower thermostatic mixer*  
• 0,6087



DOCCIA  
SHOWER

**9149**

Monocomando doccia esterno  
*Wall mounted shower single lever mixer*  
• 0,4841

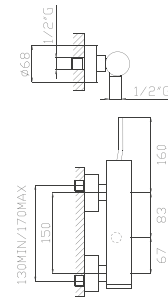

**9146**

Monocomando doccia esterno con saliscendi  
*Wall mounted shower single lever mixer with sliding bar*  
• 0,7235

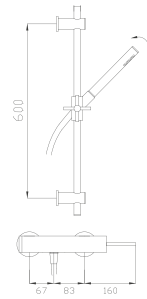

**9147**

Monocomando doccia esterno con colonna, deviatore, flessibile Cromotech, soffione e doccia in ottone  
*Wall mounted shower single lever mixer with column, diverter, Cromotech flexible hose, brass showerhead and brass handshower*  
• 0,9717

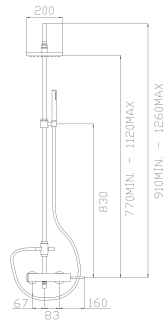

**18249**

Miscelatore termostatico doccia esterno  
*Thermostatic external shower mixer*  
• 0,3596

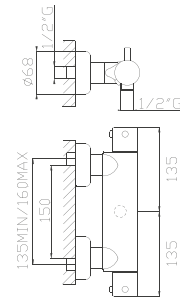

**18247**

Miscelatore termostatico doccia esterno con colonna, deviatore, flessibile Cromotech, soffione e doccia in ottone  
*Thermostatic external shower mixer with column, diverter, Cromotech flexible hose, brass showerhead and brass handshower*  
• 0,9823

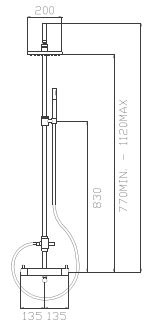

**186-C5**

Presina d'acqua e doccia in ottone con flessibile Cromotech  
*Brass wall outlet with brass handshower and Cromotech flexible hose*  
• 0,0896

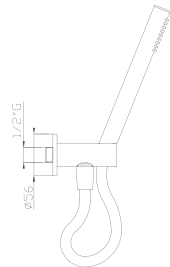

**184-02**

Presina d'acqua in ottone  
*Brass water outlet*  
• 0,0189

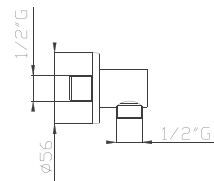

**228**

Saliscendi con asta e doccia in ottone con flessibile Cromotech  
*Brass sliding rail with brass handshower and Cromotech flexible hose*  
• 0,2394

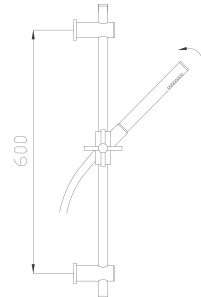

**359**

Soffione laterale esterno orientabile, in ottone  
*Brass external adjustable body jet*  
• 0,0308

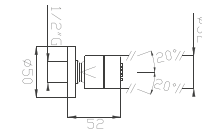

**362**

Soffione laterale a parete orientabile in ABS  
*ABS wall adjustable body jet*  
• 0,0808

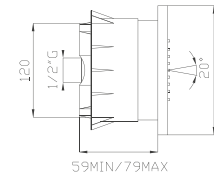

**366**

Soffione doccia in ottone con anticalcare  
*Brass shower head with antiscala*  
• 0,1175

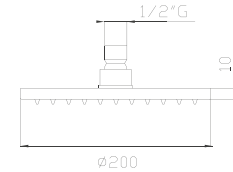

**372**

Braccio doccia in ottone  
*Brass wall shower arm*  
• 0,0389

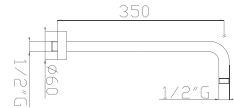

**375**

Braccio doccia a soffitto in ottone  
*Brass ceiling shower arm*  
• 0,0380

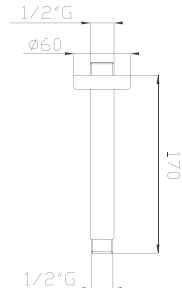

DOCCIA  
SHOWER





VASCA  
BATH

9006

Monocomando vasca/doccia ad incasso con flessibile Cromotech e doccia in ottone completo di Easy-Box  
*Concealed bath/shower single lever mixer with Cromotech flexible hose, brass handshower with Easy-Box*  
• 1,0592

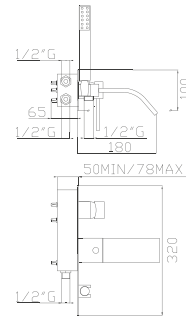

9007

Monocomando bordo vasca quattro fori  
*Four-hole deck mounted bath/shower single lever mixer*  
• 0,9205

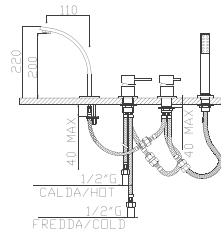

9008

Monocomando vasca con doccia in ottone e flessibile Cromotech  
*Bath single lever mixer with brass handshower and Cromotech flexible hose*  
• 0,8648

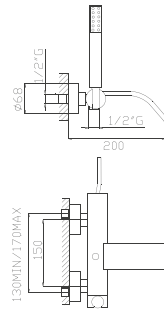

9153

Colonna vasca a pavimento con flessibile Cromotech e doccia in ottone completa di Techno-Box  
*Floor bathtub column with Cromotech flexible hose and brass handshower with Techno-Box*  
• 1,3198

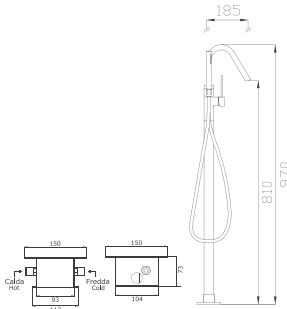

ACCESSORI  
ACCESSORIES

440

Sifone in ottone  
*Brass siphon*  
• 0,0601

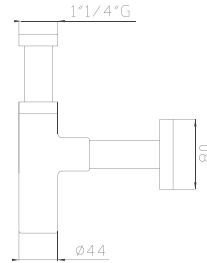

935-05

Tappo click-clack in ottone con troppo pieno  
*Brass click-clack plug with overflow*  
• 0,0451

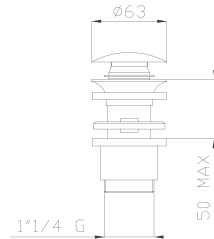

935-06

Tappo click-clack in ottone senza troppo pieno  
*Brass click-clack plug without overflow*  
• 0,0451

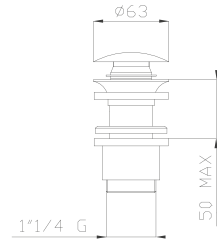

885

Rubinetto sottolavabo in ottone con filtro  
*Brass angle valve with strainer*  
• 0,0384

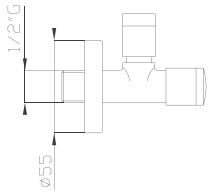

605

Bocca vasca a parete  
*Wall bath spout*  
• 0,3596

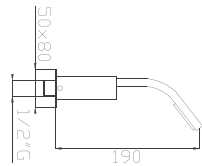



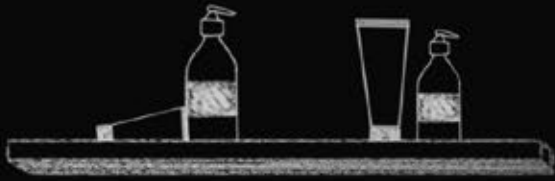

BIÈK



ART. 13030AL



ART. 13030AL



ART. 13034



ART. 13008



ART. 336-01



ART. 13187



DOCCIA  
SHOWER

**234**

Saliscendi con asta in ottone, flessibile Cromotech e doccia in ABS  
*Brass sliding rail with Cromotech flexible hose and ABS handshower*  
• 0,1626

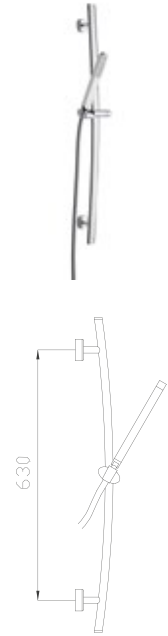

**366**

Soffione doccia in ottone con anticalcare  
*Brass shower head with antiscalc*  
• 0,1175

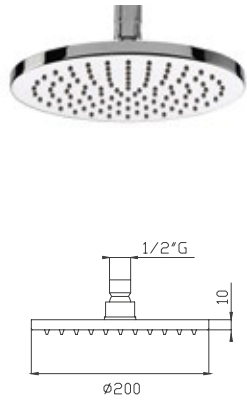

**359**

Soffione laterale esterno orientabile in ottone  
*Brass external adjustable body jet*  
• 0,0308

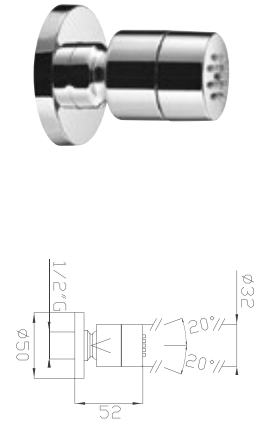

**372**

Braccio doccia in ottone  
*Brass wall shower arm*  
• 0,0389

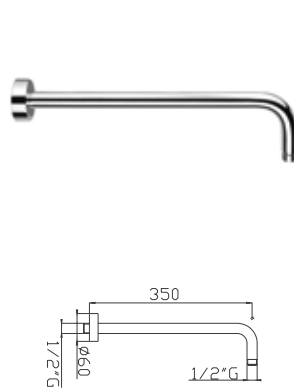

**362**

Soffione laterale a parete orientabile in ABS  
*ABS wall adjustable body jet*  
• 0,0808

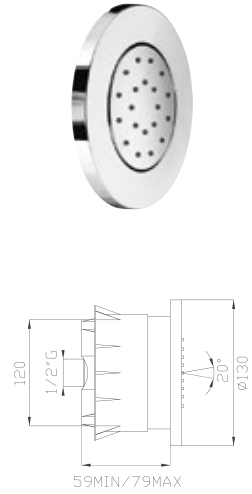

**375**

Braccio doccia a soffitto in ottone  
*Brass ceiling shower arm*  
• 0,0380

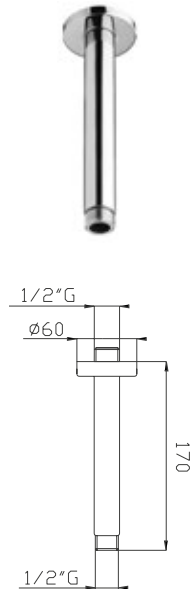

**336-01**

Soffione doccia inox a parete  
*Inox wall shower head*  
• 0,6767

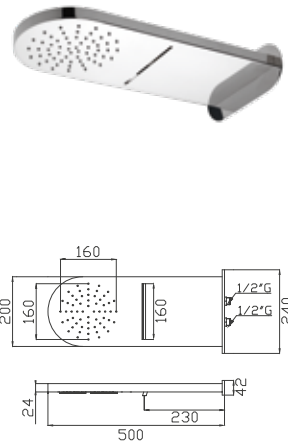

VASCA  
BATH

**13008**

Monocomando vasca con doccia in ABS e flessibile Cromotech  
*Bath single lever mixer with ABS handshower and Cromotech flexible hose*  
• 0,4638

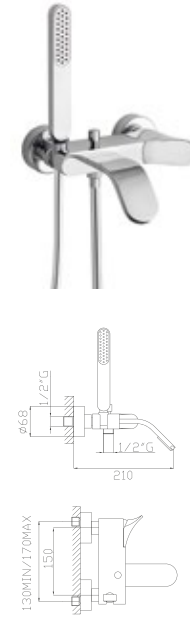

**440**

Sifone in ottone  
*Brass siphon*  
• 0,0601



ACCESSORI  
ACCESSORIES

**614**

Bocca vasca a parete  
*Wall bath spout*  
• 0,2694

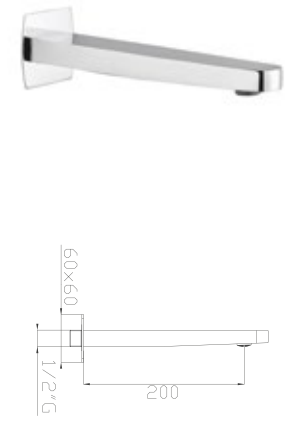

**935-05**

Tappo click-clack in ottone con troppo pieno  
*Brass click-clack plug with overflow*  
• 0,0451



**935-06**

Tappo click-clack in ottone senza troppo pieno  
*Brass click-clack plug without overflow*  
• 0,0451



**885**

Rubinetto sottolavabo in ottone con filtro  
*Angle valve with strainer*  
• 0,0384

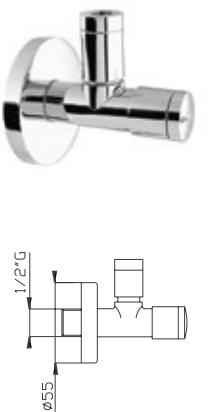



FLO



ART. 7030AL



ART. 7030





ART. 7034



ART. 232

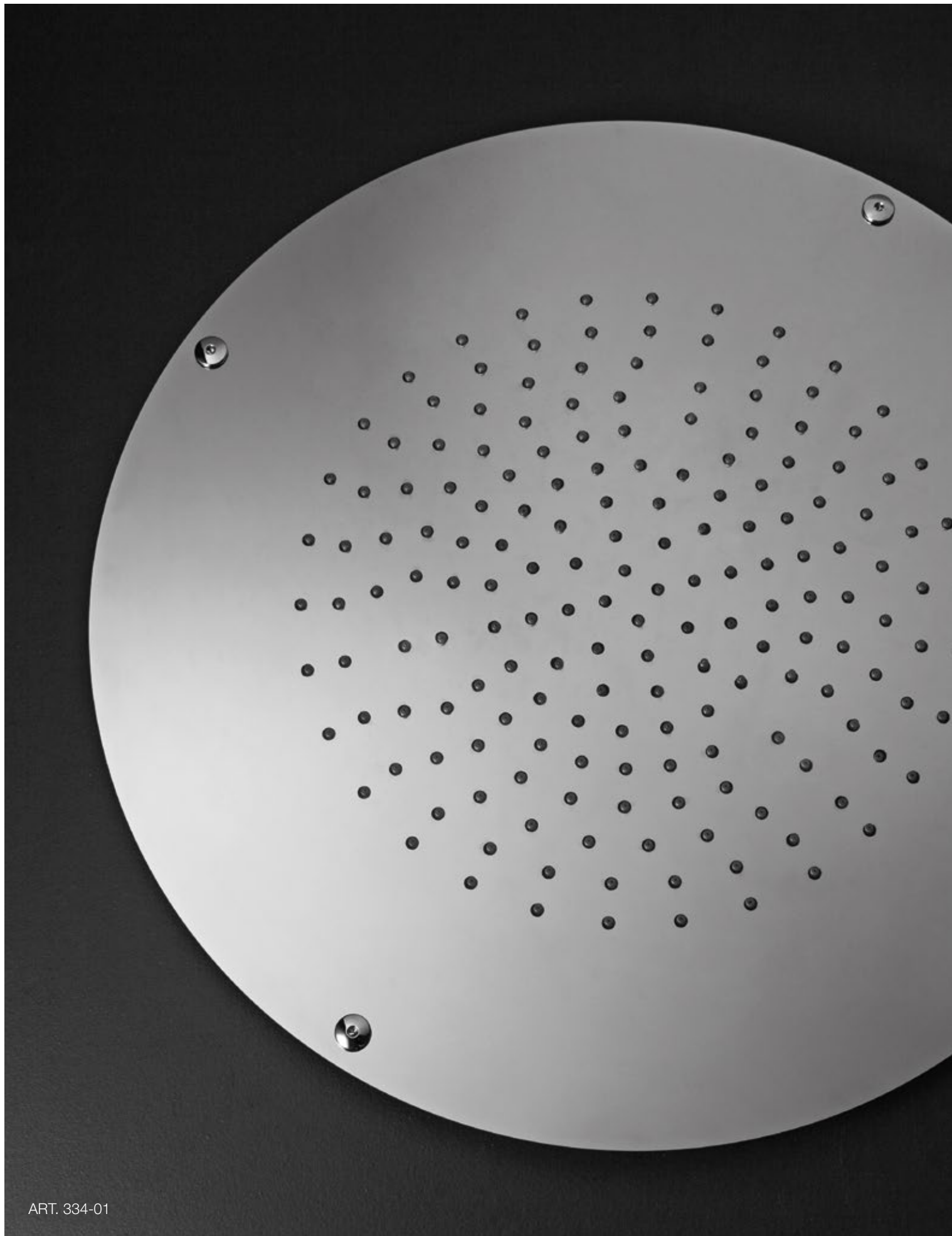

LAVABO / BIDET  
WASHBASIN / BIDET**7032**

Monocomando lavabo con scarico  
*Basin single lever mixer with pop-up waste*

- 0,4293

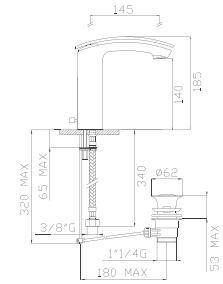
**7030**

Monocomando lavabo senza scarico  
*Basin single lever mixer without pop-up waste*

- 0,4134

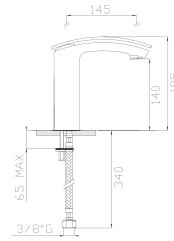
**7030AL**

Monocomando lavabo alto senza scarico  
*Tall basin single lever mixer without pop-up waste*

- 0,5380

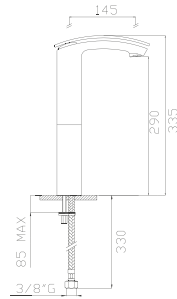
**7034**

Monocomando lavabo ad incasso **completo di Easy-Box**  
*Concealed basin single lever mixer with Easy-Box*

- 0,7518

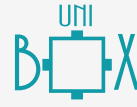
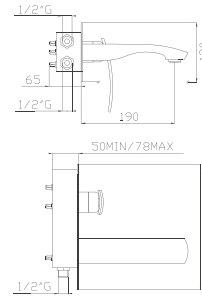

ADATTABILE AL SISTEMA **UNI-BOX**  
PER DETTAGLI VEDERE LISTINO PREZZI  
**SUITABLE FOR UNI-BOX SYSTEM**  
FOR FURTHER DETAILS SEE THE PRICE-LIST

**7187**

Monocomando doccia incasso tre uscite  
*Three-way concealed shower single lever mixer*

- 0,4956

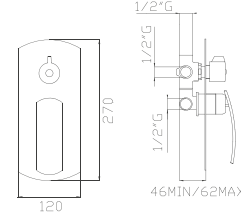
**7188**

Monocomando doccia incasso due uscite **con deviatore a pulsante**  
*Two-way concealed shower single lever mixer with push diverter*

- 0,3967

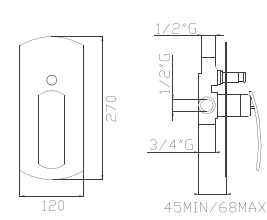
**7189**

Monocomando doccia incasso  
*Concealed shower single lever mixer*

- 0,2703

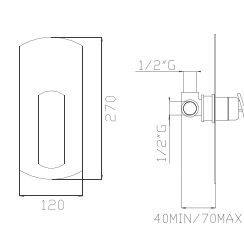
**7154**

Colonna lavabo a pavimento **completa di Techno-Box**  
*Floor basin column single lever mixer with Techno-Box*

- 1,1483

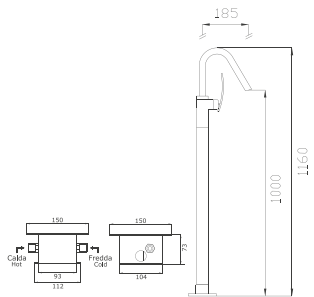
**7086**

Monocomando bidet con scarico  
*Bidet single lever mixer with pop-up waste*

- 0,4293

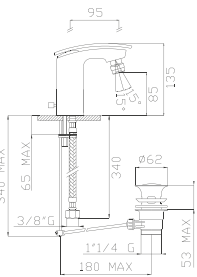
**7186**

Monocomando doccia incasso quattro uscite **non adattabile al sistema Uni-Box**  
*Four-way concealed shower single lever mixer not suitable for Uni-Box system*

- 0,4956

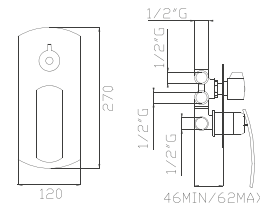
**7151**

Miscelatore termostatico doccia esterno  
*Thermostatic external shower mixer*

- 0,2686

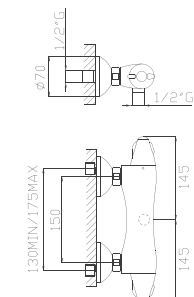
**7152**

Colonna doccia con attacco a parete  
*Shower column with wall mounting*

- 2,7869

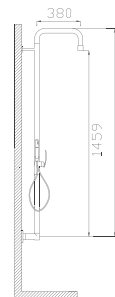
**232**

Saliscendi con asta e doccia in ottone con flessibile Cromotech  
*Brass sliding rail with brass handshower and Cromotech flexible hose*

- 0,1626

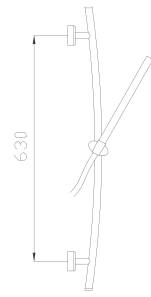
DOCCIA  
SHOWER



VASCA  
BATH

**7008**

Monocomando vasca con doccia duplex e flessibile Cromotech

*Bath and shower single lever mixer with duplex and Cromotech flexible hose*

- 0,7633

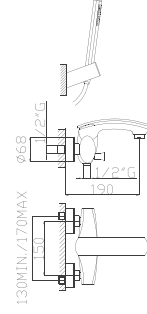

**7153**

Colonna vasca a pavimento con flessibile Cromotech e doccia in ottone completa di Techno-Box

*Floor bathtub column with Cromotech flexible hose and brass handshower with Techno-Box*

- 1,2941

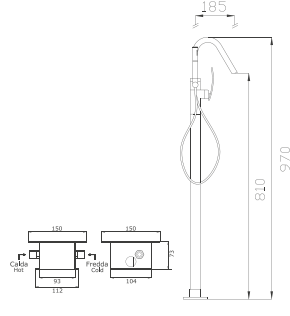

**606**

Bocca vasca a parete  
*Wall bath spout*

- 0,2659

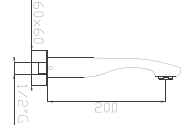



CAJET



ART. 5030AL



ART. 5030



ART. 5154



ART. 5086

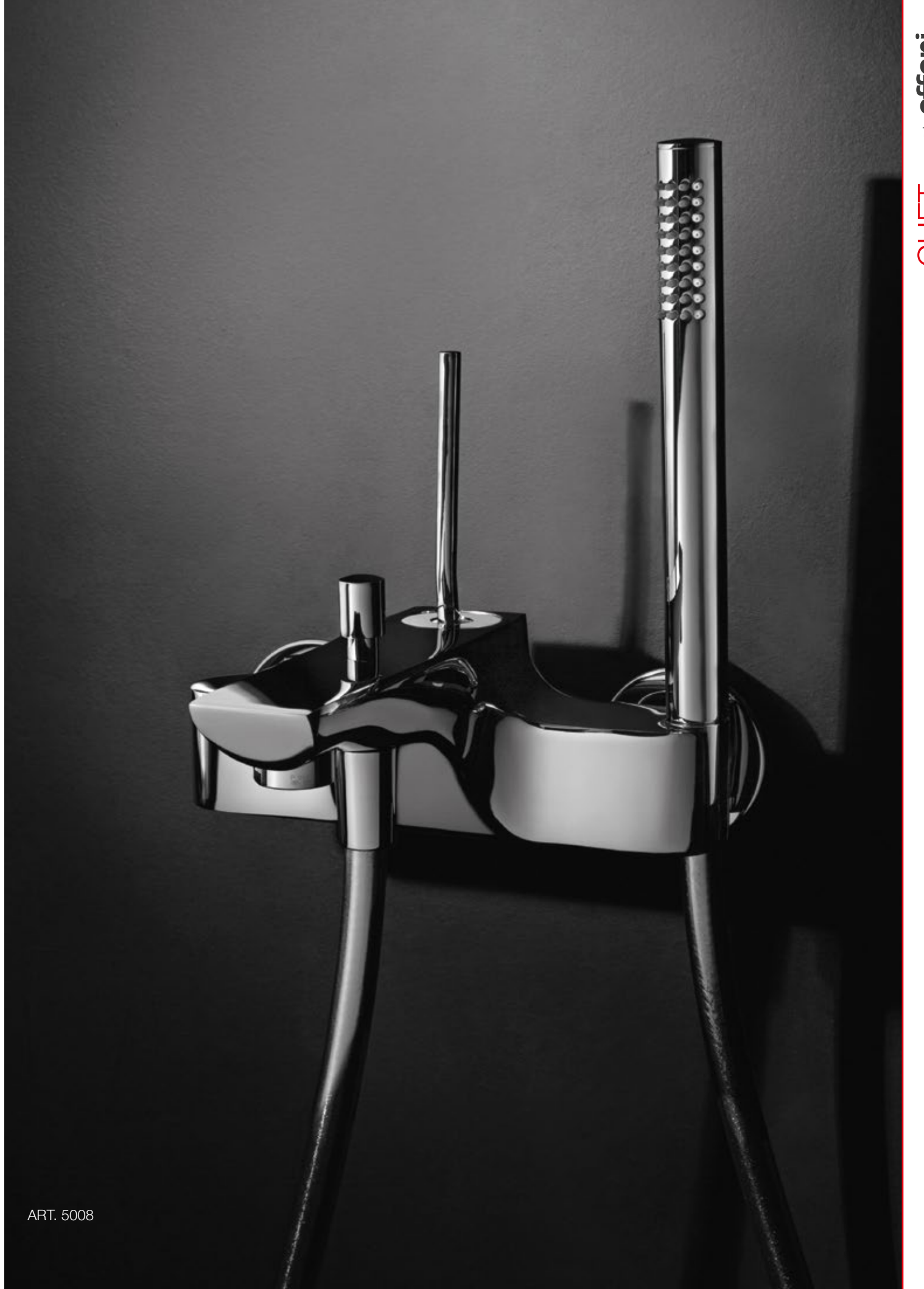





ART. 5187 + ART. 186-C5



ART. 372-RI + ART. 366-30

LAVABO / BIDET  
WASHBASIN / BIDET**5032**

Monocomando lavabo con scarico  
*Basin single lever mixer with pop-up waste*

- 0,3092

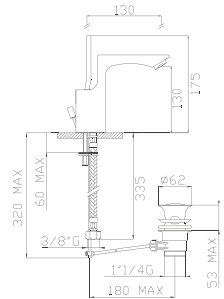
**5030**

Monocomando lavabo senza scarico  
*Basin single lever mixer without pop-up waste*

- 0,2933

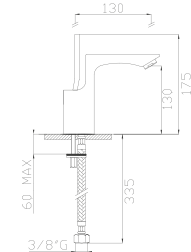
**5030AL**

Monocomando lavabo alto senza scarico  
*Tall basin single lever mixer without pop-up waste*

- 0,4453

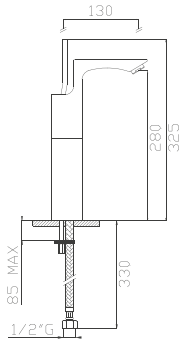
**5034**

Monocomando lavabo ad incasso **completo di Easy-Box**  
*Concealed basin single lever mixer with Easy-Box*

- 0,7350

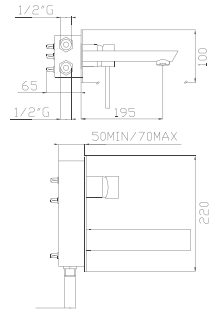
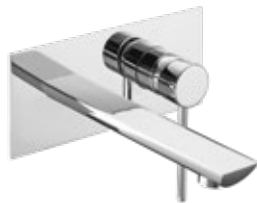

ADATTABILE AL SISTEMA **UNI-BOX**  
PER DETTAGLI VEDERE LISTINO PREZZI  
**SUITABLE FOR UNI-BOX SYSTEM**  
FOR FURTHER DETAILS SEE THE PRICE-LIST

**5187**

Monocomando doccia incasso tre uscite  
*Three-way concealed shower single lever mixer*

- 0,4947

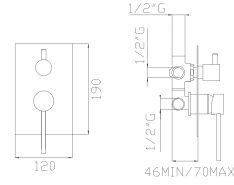
**5188**

Monocomando doccia incasso due uscite **con deviatore a pulsante**  
*Two-way concealed shower single lever mixer with push diverter*

- 0,4126

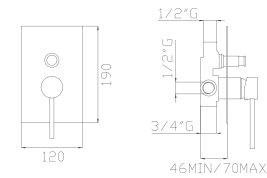
**5189**

Monocomando doccia incasso  
*Concealed shower single lever mixer*

- 0,2818

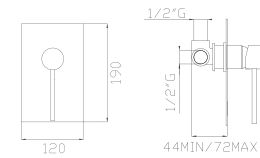
**5154**

Colonna lavabo a pavimento **completa di Techno-Box**  
*Floor basin column single lever mixer with Techno-Box*

- 1,1748

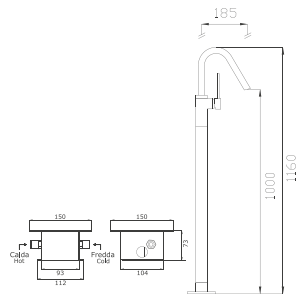
**5086**

Monocomando bidet con scarico  
*Bidet single lever mixer with pop-up waste*

- 0,3092

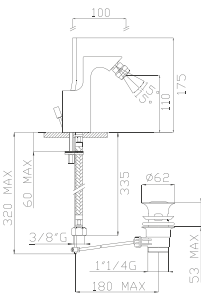
**5186**

Monocomando doccia incasso quattro uscite **non adattabile al sistema Uni-Box**  
*Four way concealed shower single lever mixer not suitable for uni-box system*

- 0,4947

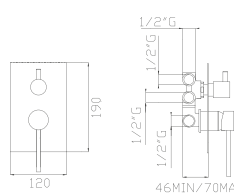
**5287**

Miscelatore termostatico doccia incasso tre uscite  
*Three way concealed shower thermostatic mixer*

- 0,7085

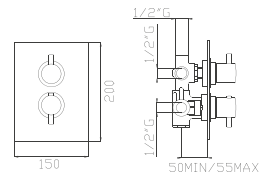
**5288**

Miscelatore termostatico doccia incasso due uscite  
*Two-way concealed shower thermostatic mixer*

- 0,6873

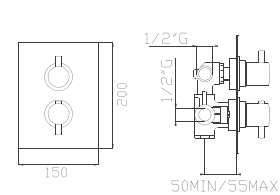
**5289**

Miscelatore termostatico doccia incasso  
*Concealed shower thermostatic mixer*

- 0,6087

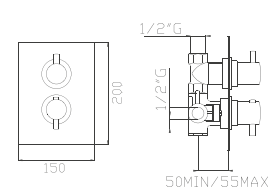
DOCCIA  
SHOWER

DOCCIA  
SHOWER**5149**

Monocomando doccia esterno

*Wall mounted shower single lever mixer*

- 0,4841

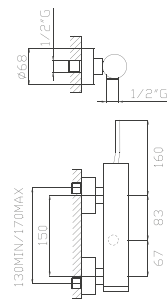
**5146**

Monocomando doccia esterno con saliscendi

*Wall mounted shower single lever mixer with sliding bar*

- 0,7235

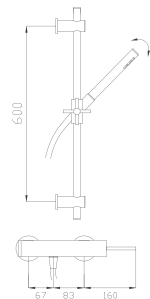
**5147**

Monocomando doccia esterno con colonna, deviatore, flessibile Cromotech, soffione e doccia in ottone

*Wall mounted shower single lever mixer with column, diverter, Cromotech flexible hose, brass showerhead and brass handshower*

- 0,9717

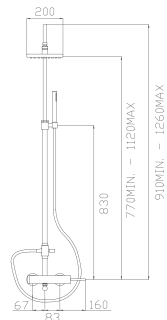
**18249**

Miscelatore termostatico doccia esterno

*Thermostatic external shower mixer*

- 0,3596

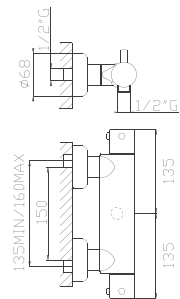
**18247**

Miscelatore termostatico doccia esterno con colonna, deviatore, flessibile Cromotech, soffione e doccia in ottone

*Thermostatic external shower mixer with column, diverter, Cromotech flexible hose, brass showerhead and brass handshower*

- 0,9823

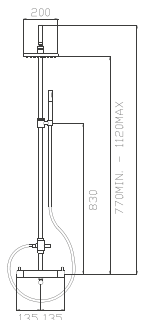
**186-C5**

Presina d'acqua e doccia in ottone con flessibile Cromotech

*Brass wall outlet with brass handshower and Cromotech flexible hose*

- 0,0896

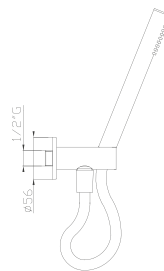
**184-02**

Presina d'acqua in ottone

*Brass water outlet*

- 0,0189

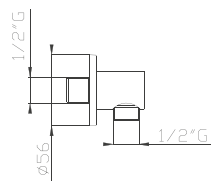
**228**

Saliscendi con asta e doccia in ottone con flessibile Cromotech

*Brass sliding rail with brass handshower and Cromotech flexible hose*

- 0,2394

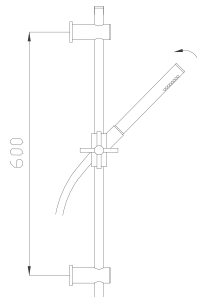
**359**

Soffione laterale esterno orientabile, in ottone

*Brass external adjustable body jet*

- 0,0308

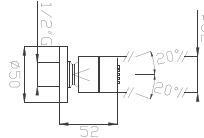
**362**

Soffione laterale a parete orientabile in ABS

*ABS wall adjustable body jet*

- 0,0808

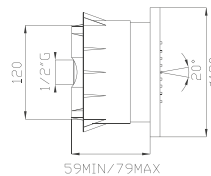
**366**

Soffione doccia in ottone con anticalcare

*Brass shower head with antiscaling*

- 0,1175

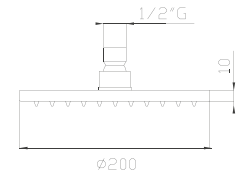
**372**

Braccio doccia in ottone

*Brass wall shower arm*

- 0,0389

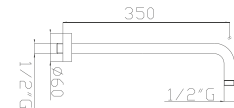
**375**

Braccio doccia a soffitto in ottone

*Brass ceiling shower arm*

- 0,0380

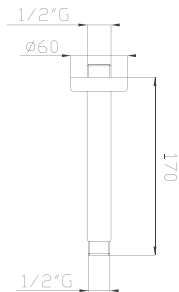
DOCCIA  
SHOWER



VASCA  
BATH

**5008**

Monocomando vasca con doccia in ottone e flessibile Cromotech  
*Bath single lever mixer with brass handshower and Cromotech flexible hose*

- 0,5601

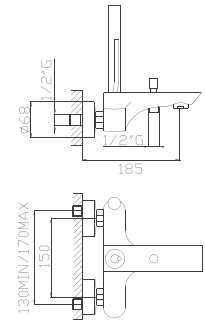

**5153**

Colonna vasca a pavimento con flessibile Cromotech e doccia in ottone **completa di Techno-Box**  
*Floor bathtub column with Cromotech flexible hose and brass handshower with Techno-Box*

- 1,3198

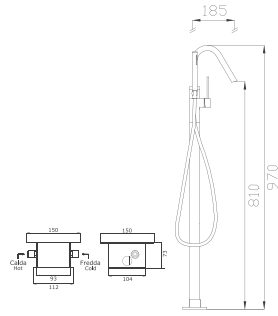

**607**

Bocca vasca a parete  
*Wall bath spout*

- 0,2863

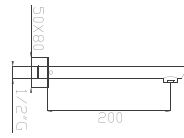

**440**

Sifone in ottone  
*Brass siphon*

- 0,0601

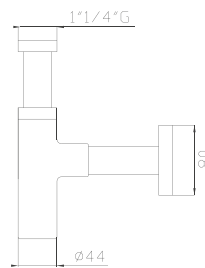

**935-05**

Tappo click-clack in ottone con troppo pieno  
*Brass click-clack plug with overflow*

- 0,0451

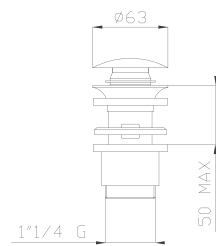

**935-06**

Tappo click-clack in ottone senza troppo pieno  
*Brass click-clack plug without overflow*

- 0,0451

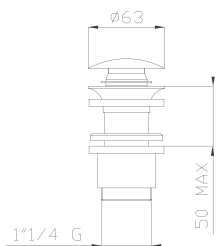

**885**

Rubinetto sottolavabo in ottone con filtro  
*Brass angle valve with strainer*

- 0,0384

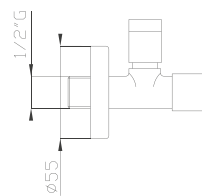

ACCESSORI  
ACCESSORIES



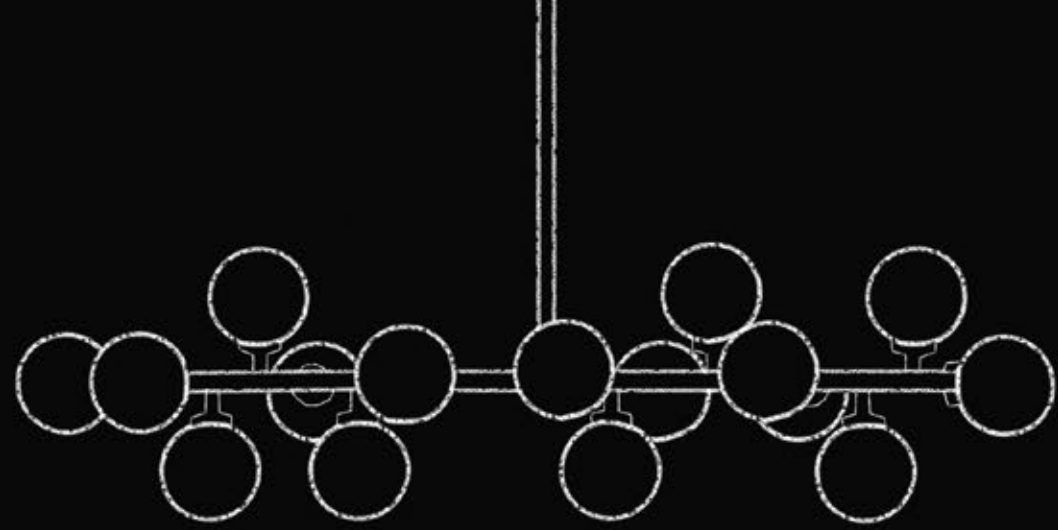

TONDI



ART. 15030



ART. 15030AL



ART. 15034



ART. 15036



ART. 15033



ART. 15037





ART. 15187



ART. 15147 + ART. 366-30

LAVABO / BIDET  
WASHBASIN / BIDET

**15032**

Monocomando lavabo con scarico  
*Basin single lever mixer with pop-up waste*  
• 0,1908

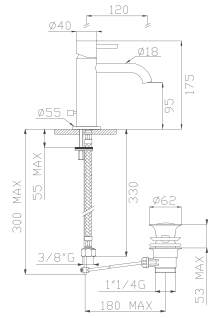

**15030**

Monocomando lavabo senza scarico  
*Basin single lever mixer without pop-up waste*  
• 0,1750

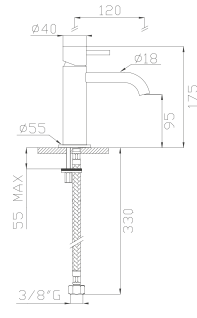

**15032LO**

Monocomando lavabo con bocca lunga con scarico  
*Basin single lever mixer with long spout with pop-up waste*  
• 0,2158

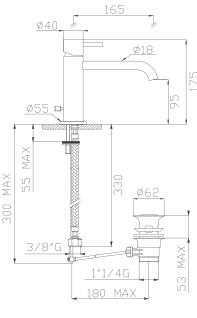

**15030LO**

Monocomando lavabo con bocca lunga senza scarico  
*Basin single lever mixer with long spout without pop-up waste*  
• 0,2000

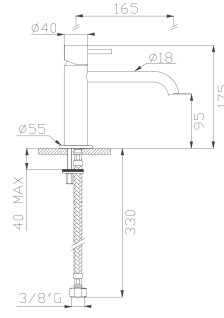

**15030AL**

Monocomando lavabo alto senza scarico  
*Tall basin single lever mixer without pop-up waste*  
• 0,2583

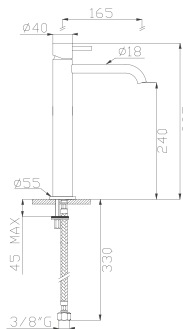

**15031**

Monocomando lavabo due fori senza scarico  
*Two-hole basin single lever mixer without waste*  
• 0,3217

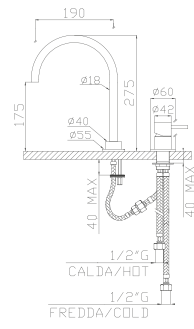

**15034**

Monocomando lavabo ad incasso **completo di Easy-Box**  
*Concealed basin single lever mixer with Easy-Box*  
• 0,3792

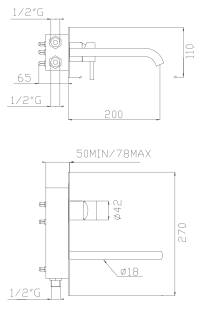

**15035**

Monocomando lavabo ad incasso  
*Concealed basin single lever mixer*  
• 0,3058

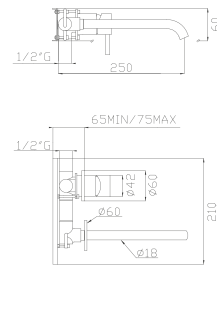

LAVABO / BIDET  
WASHBASIN / BIDET

**15033**

Monocomando lavabo da soffitto  
*Ceiling basin single lever mixer*  
• 0,4892

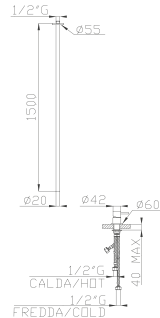

**15036**

Gruppo lavabo ad incasso  
*Three-hole concealed basin mixer*  
• 0,5183

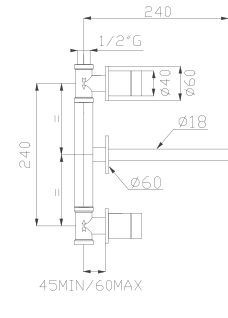

**15037**

Batteria lavabo tre fori con scarico  
*Three-hole basin mixer with pop-up waste*  
• 0,4592

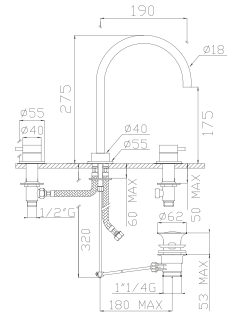

**15154**

Colonna lavabo a pavimento **completa di Techno-Box**  
*Floor basin column single lever mixer with Techno-Box*  
• 1,1750

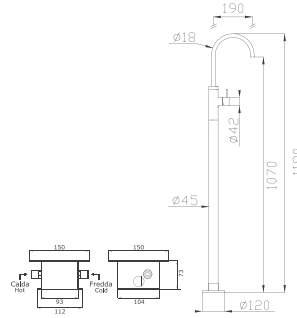

**15086**

Monocomando bidet con scarico  
*Bidet single lever mixer with pop-up waste*  
• 0,1908

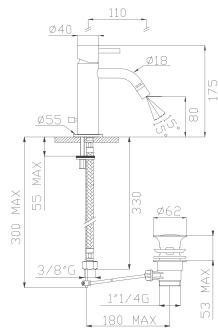

**15071**

Batteria bidet tre fori con scarico  
*Three-hole bidet mixer with pop-up waste*  
• 0,4592

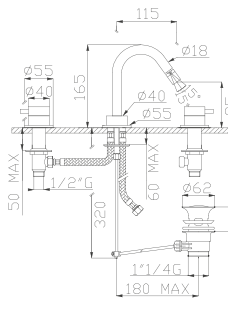



DOCCIA  
SHOWER

ADATTABILE AL SISTEMA UNI-BOX  
PER DETTAGLI VEDERE LISTINO PREZZI  
SUITABLE FOR UNI-BOX SYSTEM  
FOR FURTHER DETAILS SEE THE PRICE-LIST



15187

Monocomando doccia  
incasso tre uscite  
*Three-way concealed  
shower single lever mixer*  
• 0,2892



15185

Monocomando doccia  
incasso due uscite **con  
deviatore ceramico**  
*Two-way concealed  
shower single lever mixer  
with ceramic diverter*  
• 0,2742



15188

Monocomando doccia  
incasso due uscite **con  
deviatore a pulsante**  
*Two-way concealed  
shower single lever mixer  
with push diverter*  
• 0,1950



15189

Monocomando doccia  
incasso  
*Concealed shower  
single lever mixer*  
• 0,1117



DOCCIA  
SHOWER

15149

Monocomando doccia  
esterno  
*Wall mounted shower  
single lever mixer*  
• 0,1825

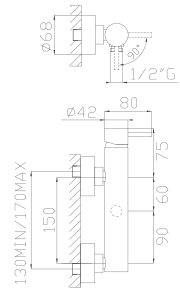

15147

Monocomando doccia  
esterno con colonna fissa,  
deviatore, flessibile Silitech,  
soffione e doccia in ABS  
*Wall mounted shower single  
lever mixer with column,  
diverter, Silitech flexible hose  
and ABS showerhead and  
ABS handshower*  
• 0,4142

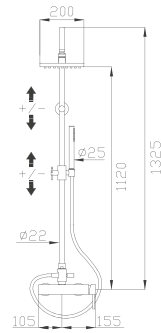

15148

Miscelatore termostatico  
doccia esterno con deviatore,  
colonna fissa, flessibile Silitech,  
soffione e doccia in ABS  
*Thermostatic external  
shower mixer with diverter,  
column, Silitech flexible  
hose and ABS showerhead  
and ABS handshower*  
• 0,4400

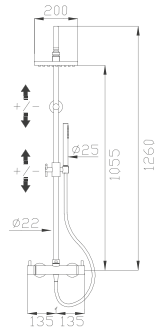

186-S1

Preso d'acqua in ottone,  
flessibile Silitech e doccia  
in ABS  
*Brass wall outlet with  
Silitech flexible hose and  
ABS handshower*  
• 0,0942

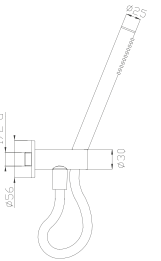

15186

Monocomando doccia  
incasso quattro uscite  
**non adattabile al  
sistema Uni-Box**  
*Four way concealed  
shower single lever mixer  
not suitable for Uni-Box  
system*  
• 0,2892

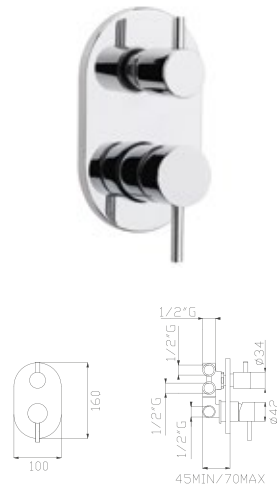

15181

Gruppo incasso doccia  
**tre uscite**  
*Three-way concealed  
shower mixer*  
• 0,5058

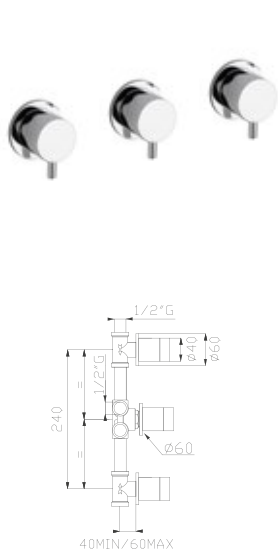

15182

Gruppo incasso doccia  
**due uscite**  
*Two-way concealed  
shower mixer*  
• 0,4775

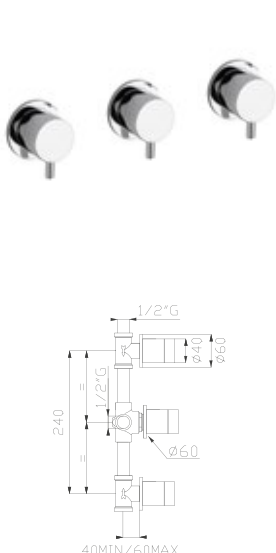

15184

Rubinetti incasso doccia  
*Concealed shower taps*  
• 0,3058

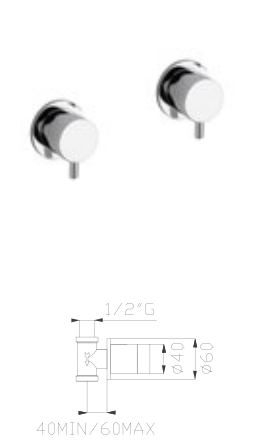

184-02

Preso d'acqua in ottone  
*Brass water outlet*  
• 0,0189

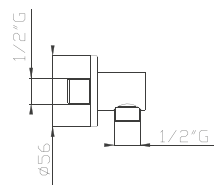

235

Saliscendi con asta in  
ottone, flessibile Silitech e  
doccia in ABS  
*Brass sliding rail with  
Silitech flexible hose and  
ABS handshower*  
• 0,1050

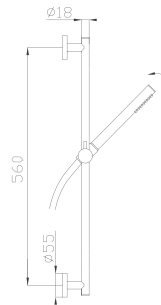

359

Soffione laterale esterno  
orientabile, in ottone  
*Brass external adjustable  
body jet*  
• 0,0308

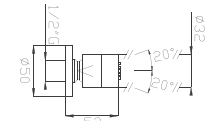

362

Soffione laterale a parete  
orientabile in ABS  
*ABS wall adjustable  
body jet*  
• 0,0808

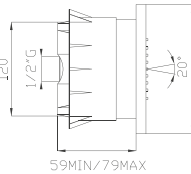

DOCCIA  
SHOWER

**366**

Soffione doccia in ottone con anticalcare  
*Brass shower head with antiscale*  
• 0,1175

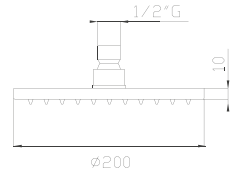

**369**

Soffione doccia in ABS con anticalcare  
*ABS shower head with antiscale*  
• 0,0720

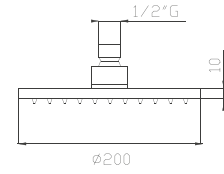

**372**

Braccio doccia in ottone  
*Brass wall shower arm*  
• 0,0389

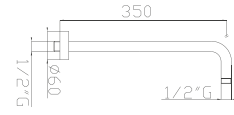

**375**

Braccio doccia in ottone a soffitto  
*Brass ceiling shower arm*  
• 0,0380

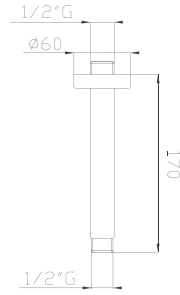
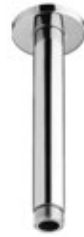

**15153**

Colonna vasca a pavimento con flessibile Silitech e doccia in ABS completa di Techno-Box  
*Floor bathtub column with Silitech flexible hose and ABS handshower with Techno-Box*  
• 1,3575

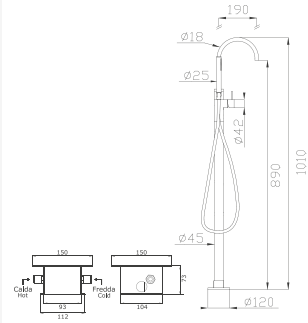

**609**

Bocca vasca a parete  
*Wall bath spout*  
• 0,0775

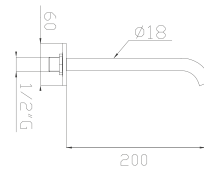

VASCA  
BATH

**15006**

Monocomando vasca/doccia ad incasso con flessibile Silitech e doccia in ABS, completo di scatola da incasso  
*Concealed bath/shower single lever mixer with Silitech flexible hose, ABS handshower and concealed box*  
• 0,6933

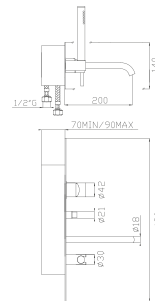

**15007**

Monocomando bordo vasca quattro fori  
*Four-hole deck mounted bath/shower single lever mixer*  
• 0,6300

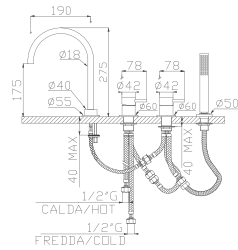

**15008**

Monocomando vasca con doccia duplex in ABS e flessibile Silitech  
*Bath and shower single lever mixer with ABS duplex and Silitech flexible hose*  
• 0,3117

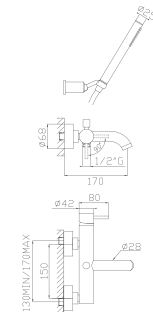

**15016**

Monocomando vasca con colonne a pavimento flessibile Silitech e doccia in ABS  
*Bath single lever mixer with floor columns, Silitech flexible hose and ABS handshower*  
• 0,6233

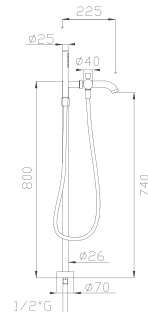

ACCESSORI  
ACCESSORIES

**440**

Sifone in ottone  
*Brass siphon*  
• 0,0601

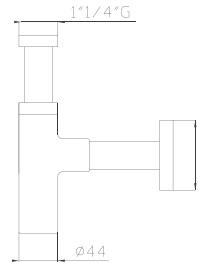

**935-05**

Tappo click-clack in ottone con troppo pieno  
*Brass click-clack plug with overflow*  
• 0,0451

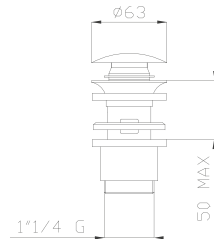

**935-06**

Tappo click-clack in ottone senza troppo pieno  
*Brass click-clack plug without overflow*  
• 0,0451

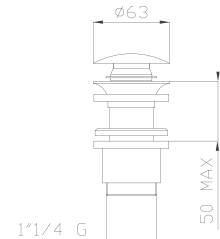

**885**

Rubinetto sottolavabo in ottone con filtro  
*Brass angle valve with strainer*  
• 0,0384

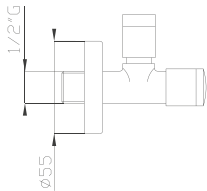



TOSCA



ART. 2032



ART. 2154

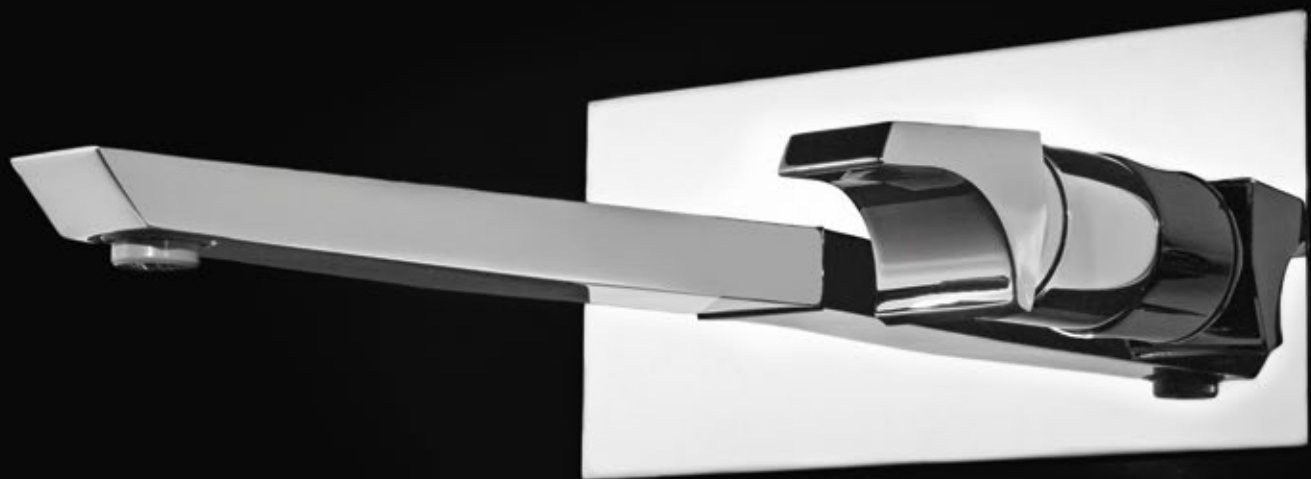

ART. 2034



ART. 2148



ART. 2187



ART. 335-01



LAVABO / BIDET  
WASHBASIN / BIDET**2032**

Monocomando lavabo  
con scarico  
*Basin single lever mixer  
with pop-up waste*

- 0,2986

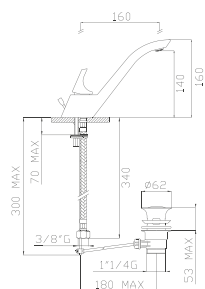
**2030**

Monocomando lavabo  
senza scarico  
*Basin single lever mixer  
without pop-up waste*

- 0,2827

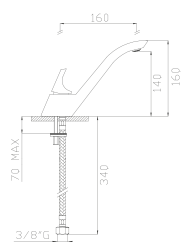
**2034**

Monocomando lavabo  
ad incasso **completo**  
di **Easy-Box**  
*Concealed basin single  
lever mixer with Easy-Box*

- 0,6758

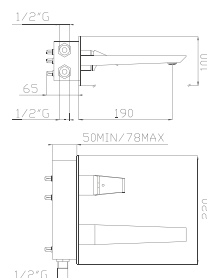
**2154**

Colonna lavabo a  
pavimento **completa**  
di **Techno-Box**  
*Floor basin column  
single lever mixer  
with Techno-Box*

- 1,2297

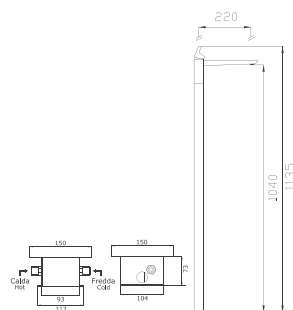

ADATTABILE AL SISTEMA **UNI-BOX**  
PER DETTAGLI VEDERE LISTINO PREZZI  
**SUITABLE FOR UNI-BOX SYSTEM**  
FOR FURTHER DETAILS SEE THE PRICE-LIST

**2187**

Monocomando doccia  
incasso tre uscite  
*Three-way concealed  
shower single lever mixer*

- 0,4762

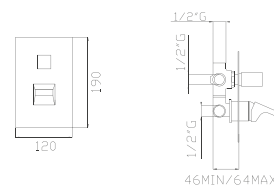
**2188**

Monocomando doccia  
incasso due uscite **con  
deviatore a pulsante**  
*Two-way concealed  
shower single lever mixer  
with push diverter*

- 0,3383

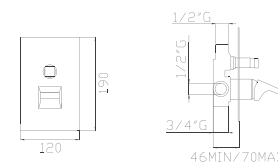
**2189**

Monocomando doccia  
incasso  
*Concealed shower  
single lever mixer*

- 0,1855

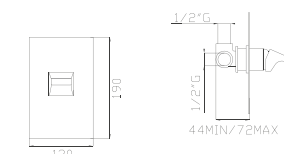
**2086**

Monocomando bidet  
con scarico  
*Bidet single lever mixer  
with pop-up waste*

- 0,2986

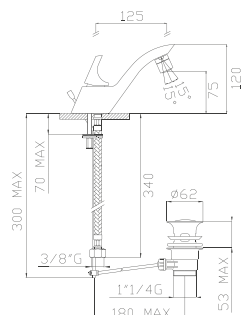
**2186**

Monocomando doccia  
incasso quattro uscite  
**non adattabile al  
sistema Uni-Box**  
*Four way concealed  
shower single lever mixer  
not suitable for Uni-Box  
system*

- 0,4762

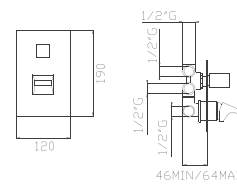
**18387**

Miscelatore termostatico  
doccia incasso tre uscite  
*Three-way concealed  
shower thermostatic  
mixer*

- 0,7994

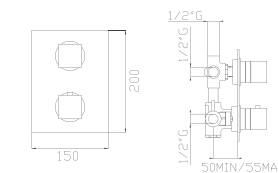
**18388**

Miscelatore termostatico  
doccia incasso due  
uscite  
*Two-way concealed  
shower thermostatic  
mixer*

- 0,7773

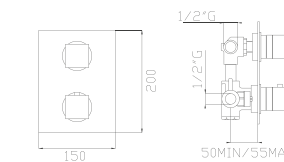
**18389**

Miscelatore termostatico  
doccia incasso  
*Concealed shower  
thermostatic mixer*

- 0,7041

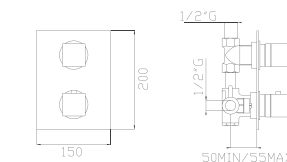
DOCCIA  
SHOWER

DOCCIA  
SHOWER

**2149**

Monocomando doccia esterno  
*Wall mounted shower single lever mixer*  
• 0,3631

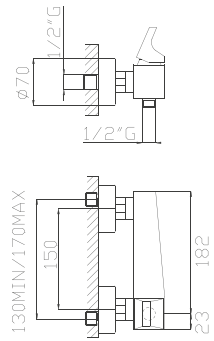

**2148**

Monocomando doccia esterno con doccia in ottone e flessibile Cromotech  
*Wall mounted shower single lever mixer with brass handshower and Cromotech flexible hose*  
• 0,4311

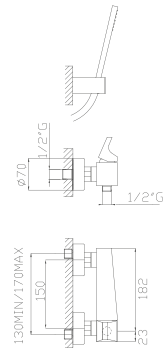

**18344**

Miscelatore termostatico doccia esterno  
*Thermostatic external shower mixer*  
• 0,6113

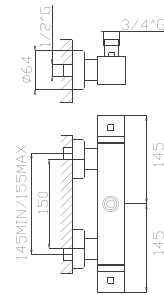

**18349**

Miscelatore termostatico doccia esterno  
*Thermostatic external shower mixer*  
• 0,5689

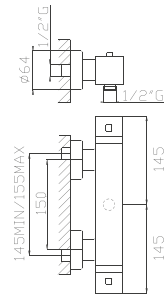

**18347**

Miscelatore termostatico doccia esterno con colonna, deviatore, flessibile Cromotech, soffione e doccia in ottone  
*Thermostatic external shower mixer with column, diverter, Cromotech flexible hose, brass showerhead and brass handshower*  
• 1,1784

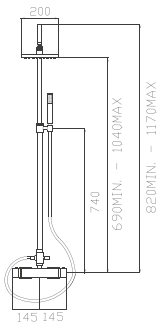

**186-C6**

Presina d'acqua e doccia in ottone con flessibile Cromotech  
*Brass wall outlet with brass handshower and Cromotech flexible hose*  
• 0,1065

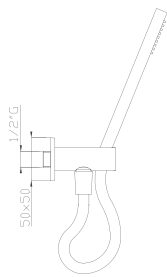

**184-03**

Presina d'acqua in ottone  
*Brass water outlet*  
• 0,0296

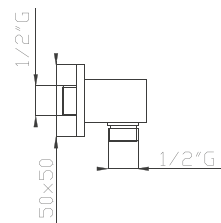

**229**

Saliscendi con asta e doccia in ottone con flessibile Cromotech  
*Brass sliding rail with brass handshower and Cromotech flexible hose*  
• 0,2456

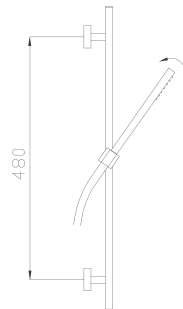

**360**

Soffione laterale esterno orientabile, in ottone  
*Brass external adjustable body jet*  
• 0,0445

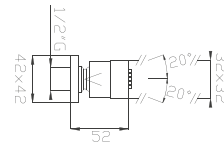

**363**

Soffione laterale a parete orientabile in ABS  
*ABS wall adjustable body jet*  
• 0,0852

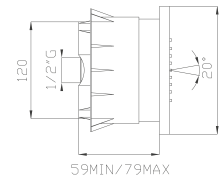

**367**

Soffione doccia in ottone con anticalcare  
*Brass shower head with antiscala*  
• 0,1546

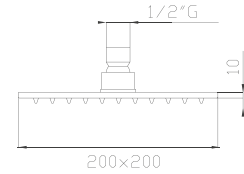

**376**

Braccio doccia in ottone  
*Brass wall shower arm*  
• 0,0831

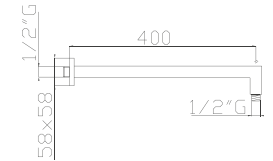

**377**

Braccio doccia a soffitto in ottone  
*Brass ceiling shower arm*  
• 0,0804

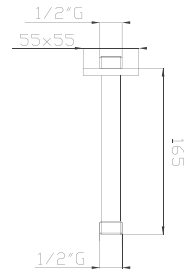

DOCCIA  
SHOWER



VASCA  
BATH

**2008**

Monocomando vasca con doccia duplex e flessibile Cromotech  
*Bath and shower single lever mixer with duplex and Cromotech flexible hose*

- 0,4929

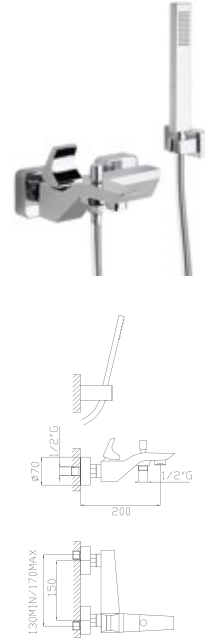

**613**

Bocca vasca a parete  
*Wall bath spout*

- 0,2694

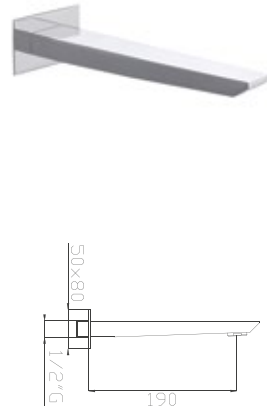

**442**

Sifone in ottone  
*Brass siphon*

- 0,0848

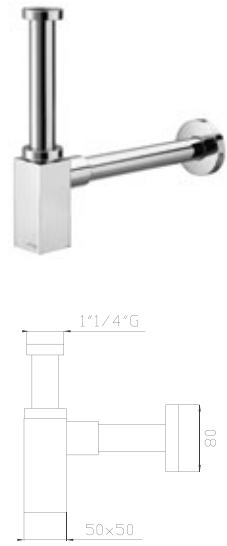

**953-05**

Tappo click-clack in ottone con troppo pieno  
*Brass click-clack plug with overflow*

- 0,0548



**953-06**

Tappo click-clack in ottone senza troppo pieno  
*Brass click-clack plug without overflow*

- 0,0548



**884**

Rubinetto sottolavabo in ottone con filtro  
*Brass angle valve with strainer*

- 0,0919

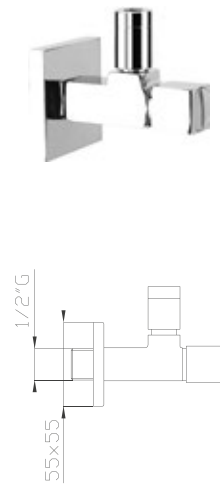

ACCESSORI  
ACCESSORIES





|||



H-TRE



ART. 14032



ART. 14030AL



ART. 14086



ART. 14007



ART. 14187

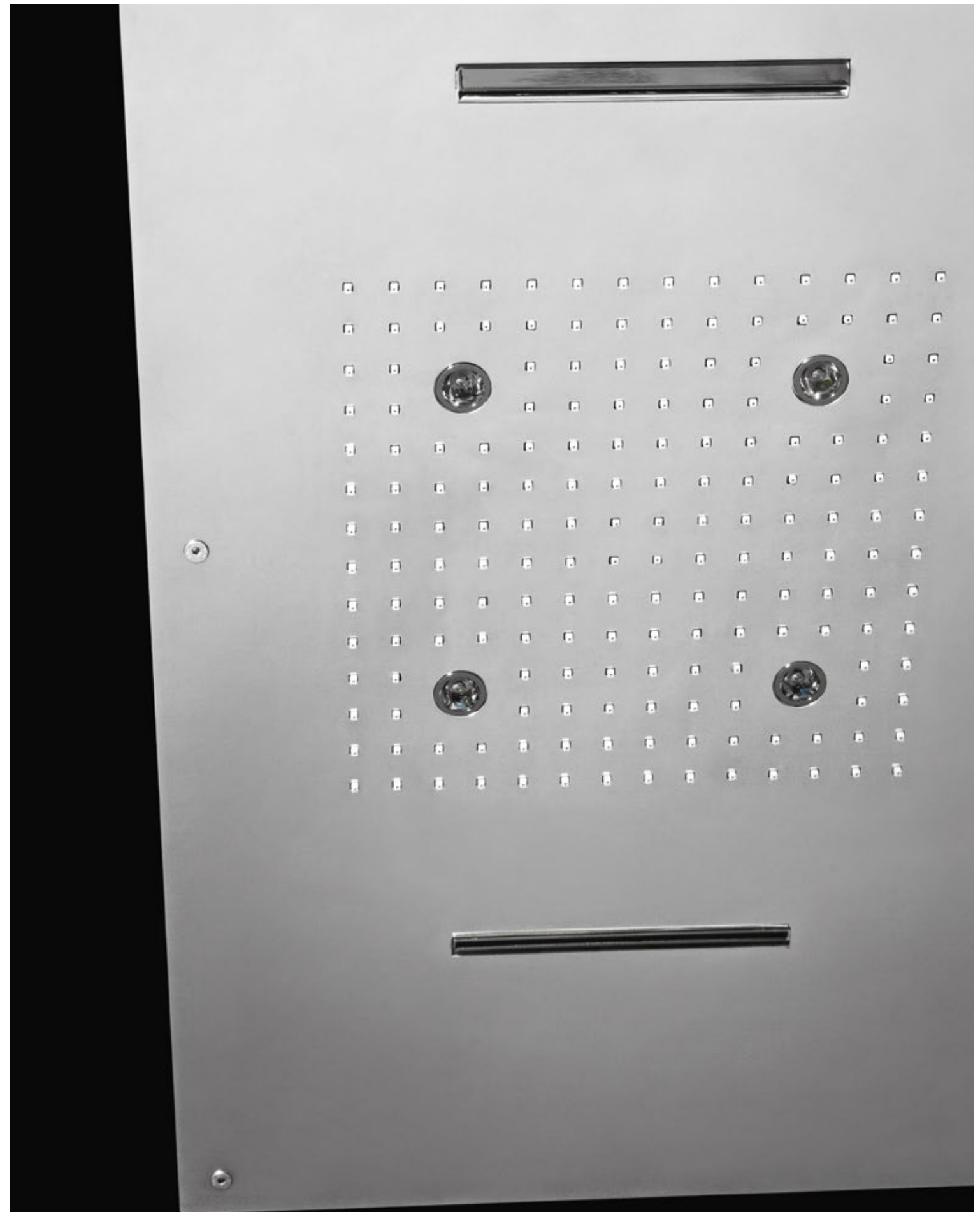

ART. 331-01

LAVABO / BIDET  
WASHBASIN / BIDET

**14032**

Monocomando lavabo con scarico  
*Basin single lever mixer with pop-up waste*  
• 0,2908

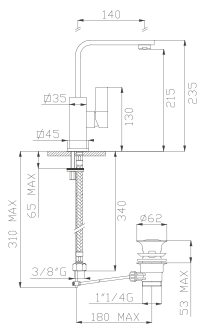

**14030**

Monocomando lavabo senza scarico  
*Basin single lever mixer without pop-up waste*  
• 0,2767

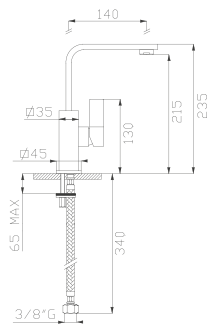

**14032LO**

Monocomando lavabo con bocca lunga con scarico  
*Basin single lever mixer with long spout with pop-up waste*  
• 0,2950

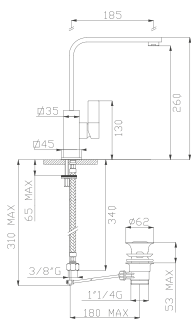

**14030LO**

Monocomando lavabo con bocca lunga senza scarico  
*Basin single lever mixer with long spout without pop-up waste*  
• 0,2800

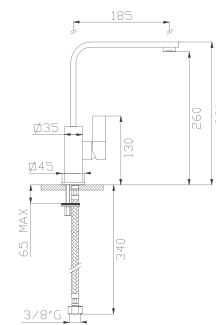

**14036**

Gruppo lavabo ad incasso  
*Three-hole concealed basin mixer*

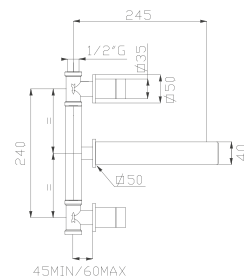

**14037**

Batteria lavabo tre fori con scarico  
*Three-hole basin mixer with pop-up waste*

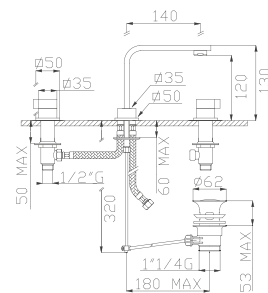

**14154**

Colonna lavabo a pavimento **completa di Techno-Box**  
*Floor basin column single lever mixer with Techno-Box*  
• 1,1616

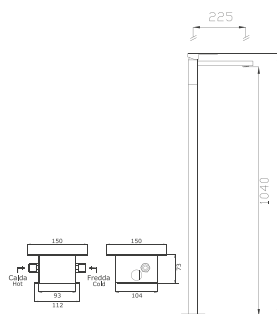

**14086**

Monocomando bidet con scarico  
*Bidet single lever mixer with pop-up waste*  
• 0,2908

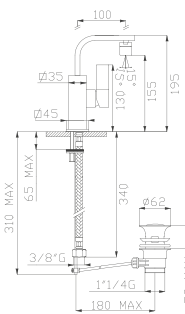

**14030AL**

Monocomando lavabo alto senza scarico  
*Tall basin single lever mixer without pop-up waste*  
• 0,3875

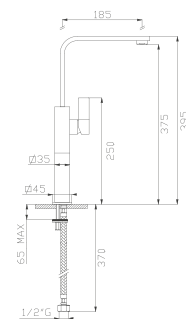

**14031**

Monocomando lavabo due fori senza scarico  
*Two-hole basin single lever mixer without waste*  
• 0,4217

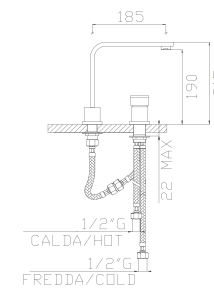

**14034**

Monocomando lavabo ad incasso **completo di Easy-Box**  
*Concealed basin single lever mixer with Easy-Box*  
• 0,5242

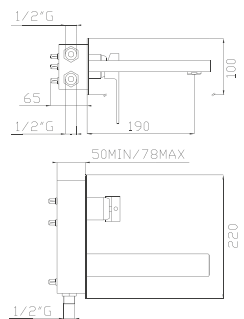

**14033**

Monocomando lavabo da soffitto  
*Ceiling basin single lever mixer*

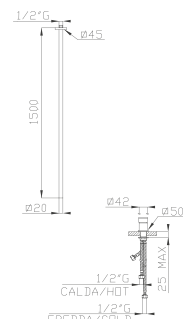

**14071**

Batteria bidet tre fori con scarico  
*Three-hole bidet mixer with pop-up waste*

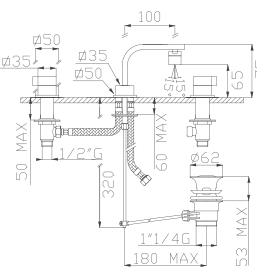
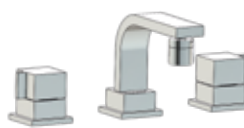





DOCCIA  
SHOWER

ADATTABILE AL SISTEMA UNI-BOX  
PER DETTAGLI VEDERE LISTINO PREZZI  
SUITABLE FOR UNI-BOX SYSTEM  
FOR FURTHER DETAILS SEE THE PRICE-LIST



14187

Monocomando doccia  
incasso tre uscite  
*Three-way concealed  
shower single lever mixer*  
• 0,3392

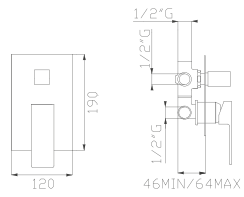

14185

Monocomando doccia  
incasso due uscite **con  
deviatore ceramico**  
*Two-way concealed  
shower single lever mixer  
with ceramic diverter*  
• 0,3225

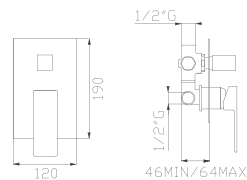

14188

Monocomando doccia  
incasso due uscite **con  
deviatore a pulsante**  
*Two-way concealed  
shower single lever mixer  
with push diverter*  
• 0,2559

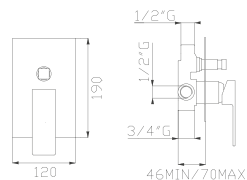

14189

Monocomando doccia  
incasso  
*Concealed shower  
single lever mixer*  
• 0,1659

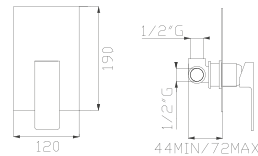

18387

Miscelatore termostatico  
doccia incasso tre uscite  
*Three-way concealed  
shower thermostatic  
mixer*  
• 0,7994

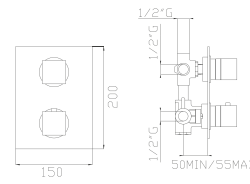

18388

Miscelatore termostatico  
doccia incasso due  
uscite  
*Two-way concealed  
shower thermostatic  
mixer*  
• 0,7773

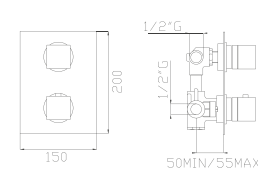

18389

Miscelatore termostatico  
doccia incasso  
*Concealed shower  
thermostatic mixer*  
• 0,7041

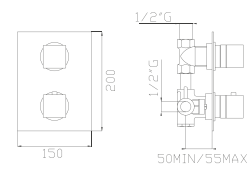

14149

Monocomando doccia  
esterno  
*Wall mounted shower  
single lever mixer*  
• 0,3110

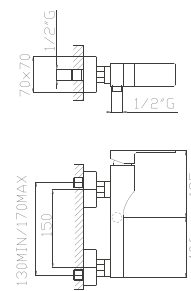

14186

Monocomando doccia  
incasso quattro uscite  
**non adattabile al  
sistema Uni-Box**  
*Four way concealed  
shower single lever mixer  
not suitable for Uni-Box  
system*  
• 0,3392

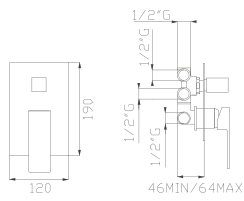

14181

Gruppo incasso doccia  
**tre uscite**  
*Three-way concealed  
shower mixer*

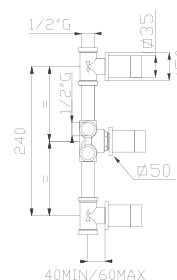

14182

Gruppo incasso doccia  
**due uscite**  
*Two-way concealed  
shower mixer*

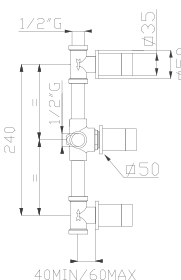

14184

Rubinetti incasso doccia  
*Concealed shower taps*

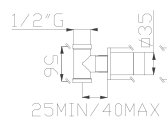

14147

Monocomando doccia esterno  
con colonna, deviatore,  
flessibile Cromotech,  
soffione e doccia in ottone  
*Wall mounted shower single  
lever mixer with column,  
diverter, Cromotech flexible  
hose, brass showerhead  
and brass handshower*  
• 0,8357

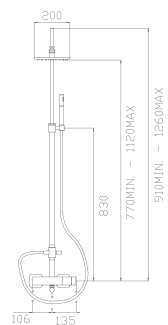

18344

Miscelatore termostatico  
doccia esterno  
*Thermostatic external  
shower mixer*  
• 0,6113

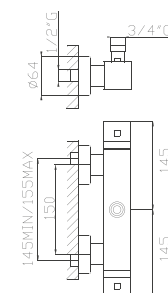

18349

Miscelatore termostatico  
doccia esterno  
*Thermostatic external  
shower mixer*  
• 0,5689

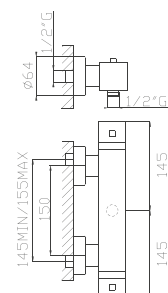

18347

Miscelatore termostatico  
doccia esterno con colonna,  
deviatore, flessibile Cromotech,  
soffione e doccia in ottone  
*Thermostatic external shower  
mixer with column, diverter,  
Cromotech flexible hose,  
brass showerhead and brass  
handshower*  
• 1,1784

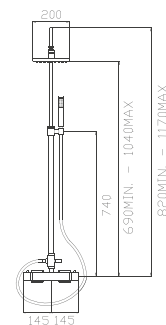

DOCCIA  
SHOWER





DOCCIA  
SHOWER

**186-C6**

Preso d'acqua e doccia in ottone con flessibile Cromotech

*Brass wall outlet with brass handshower and Cromotech flexible hose*

- 0,1065



**184-03**

Preso d'acqua in ottone  
*Brass water outlet*

- 0,0296



**229**

Saliscendi con asta e doccia in ottone con flessibile Cromotech

*Brass sliding rail with brass handshower and Cromotech flexible hose*

- 0,2456

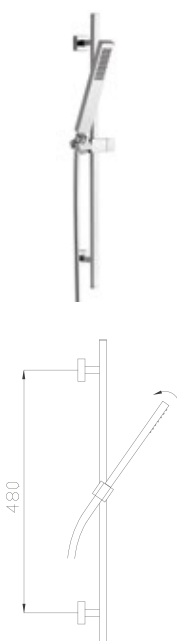

**360**

Soffione laterale esterno orientabile, in ottone  
*Brass external adjustable body jet*

- 0,0445

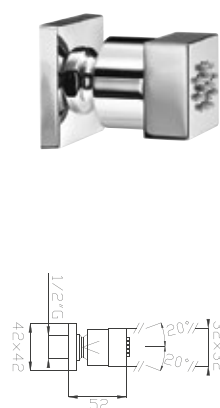

VASCA  
BATH

**14006**

Monocomando vasca/doccia ad incasso con flessibile Cromotech e doccia in ottone, completo di scatola da incasso

*Concealed bath/shower single lever mixer with Cromotech flexible hose, brass handshower and concealed box*

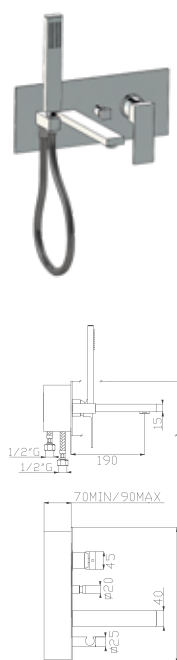

**14007**

Monocomando bordo vasca quattro fori  
*Four-hole deck mounted bath/shower single lever mixer*

- 0,7626

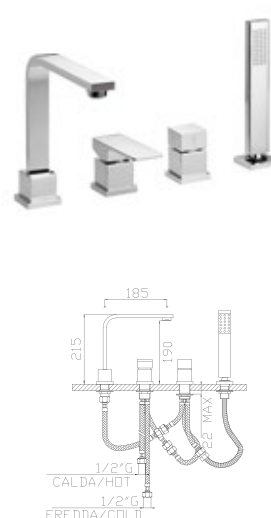

**14008**

Monocomando vasca con doccia duplex e flessibile Cromotech  
*Bath and shower single lever mixer with duplex and Cromotech flexible hose*

- 0,3763



**612**

Bocca vasca a parete  
*Wall bath spout*

- 0,2315



**363**

Soffione laterale a parete orientabile in ABS  
*ABS wall adjustable body jet*

- 0,0852

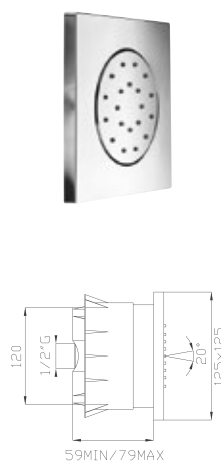

**367**

Soffione doccia in ottone con anticalcare  
*Brass shower head with antiscala*

- 0,1546

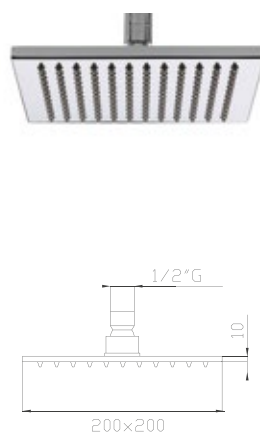

**376**

Braccio doccia in ottone  
*Brass wall shower arm*

- 0,0831

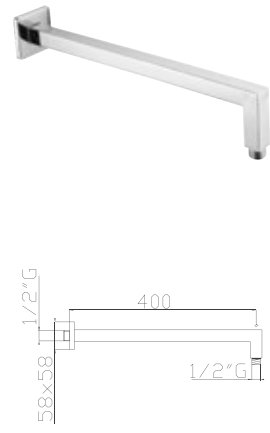

**377**

Braccio doccia a soffitto in ottone  
*Brass ceiling shower arm*

- 0,0804

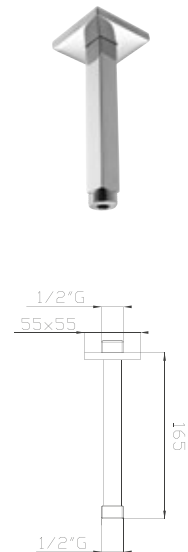

ACCESSORI  
ACCESSORIES

**442**

Sifone in ottone  
*Brass siphon*

- 0,0848



**953-05**

Tappo click-clack in ottone con troppo pieno  
*Brass click-clack plug with overflow*

- 0,0548



**953-06**

Tappo click-clack in ottone senza troppo pieno  
*Brass click-clack plug without overflow*

- 0,0548



**884**

Rubinetto sottolavabo in ottone con filtro  
*Brass angle valve with strainer*

- 0,0919

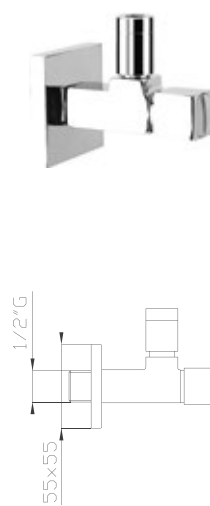





ART. 20030



ART. 20032



ART. 20030AL



ART. 20030LO



ART. 20034



ART. 20008



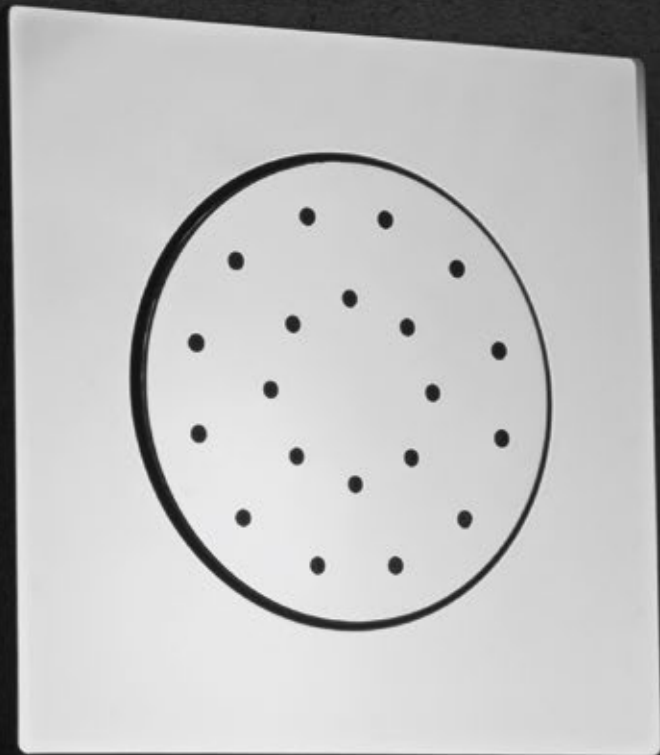

ART. 363

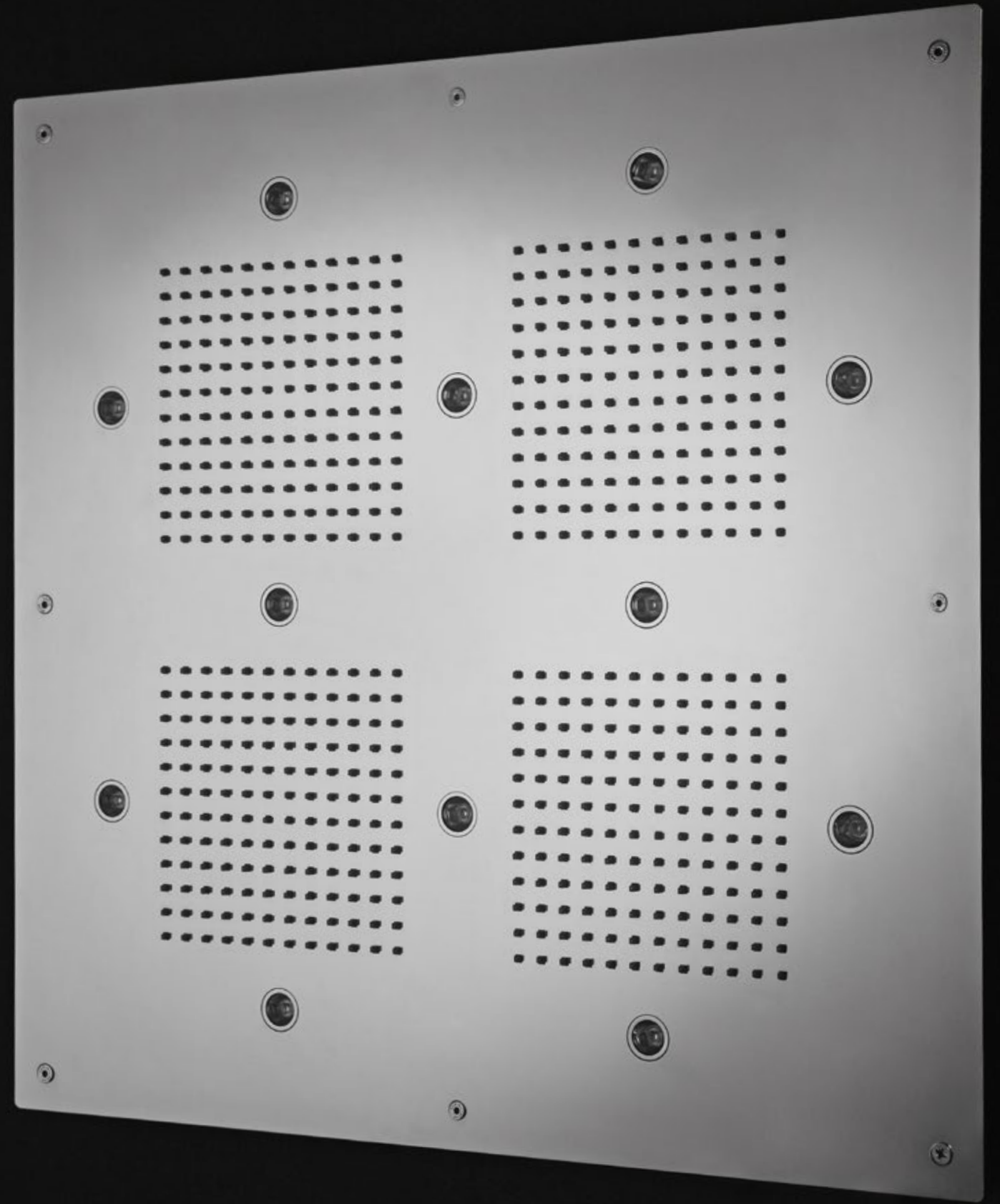

ART. 330-01

LAVABO / BIDET  
WASHBASIN / BIDET

20032

Monocomando lavabo con scarico  
*Basin single lever mixer with pop-up waste*  
• 0,1962

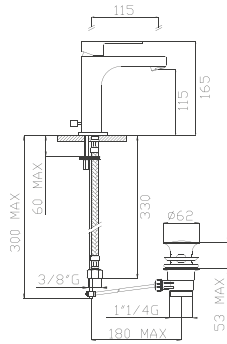

20030

Monocomando lavabo senza scarico  
*Basin single lever mixer without pop-up waste*  
• 0,1811

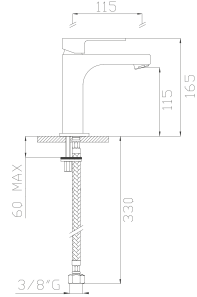

20032LO

Monocomando lavabo con bocca lunga con scarico  
*Basin single lever mixer with long spout with pop-up waste*  
• 0,2412

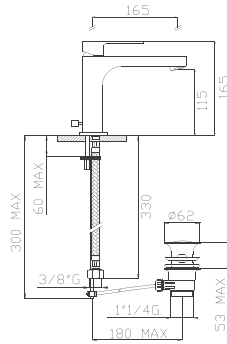

20030LO

Monocomando lavabo con bocca lunga senza scarico  
*Basin single lever mixer with long spout without pop-up waste*  
• 0,2253

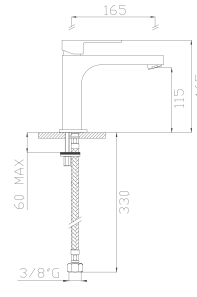

LAVABO / BIDET  
WASHBASIN / BIDET

20086

Monocomando bidet con scarico  
*Bidet single lever mixer with pop-up waste*  
• 0,1962

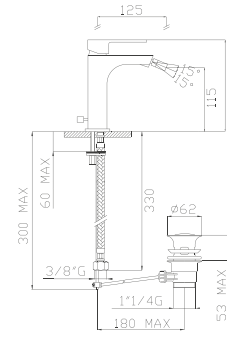

20030AL

Monocomando lavabo alto senza scarico  
*Tall basin single lever mixer without pop-up waste*  
• 0,2978

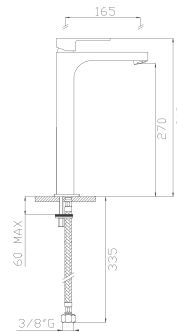

20031

Monocomando lavabo due fori senza scarico  
*Two-hole basin single lever mixer without pop-up waste*  
• 0,4214

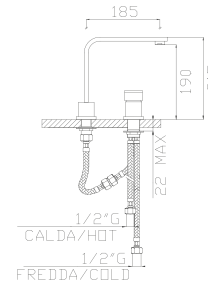

20034

Monocomando lavabo ad incasso **completo di Easy-Box**  
*Concealed basin single lever mixer with Easy-Box*  
• 0,5238

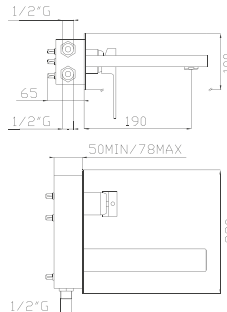

20154

Colonna lavabo a pavimento **completa di Techno-Box**  
*Floor basin column single lever mixer with Techno-Box*  
• 1,1616

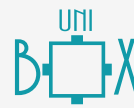
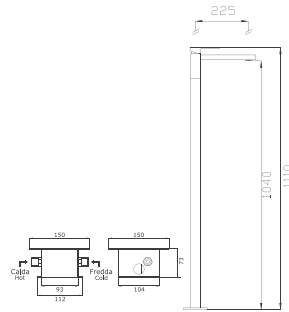

ADATTABILE AL SISTEMA **UNI-BOX**  
PER DETTAGLI VEDERE LISTINO PREZZI  
SUITABLE FOR **UNI-BOX SYSTEM**  
FOR FURTHER DETAILS SEE THE PRICE LIST

DOCCIA  
SHOWER

20187

Monocomando doccia incasso tre uscite  
*Three-way concealed shower single lever mixer*  
• 0,3118

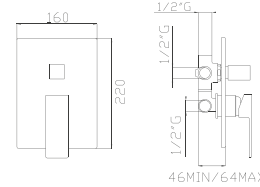

20185

Monocomando doccia incasso due uscite **con deviatore ceramico**  
*Two-way concealed shower single lever mixer with ceramic diverter*  
• 0,2942

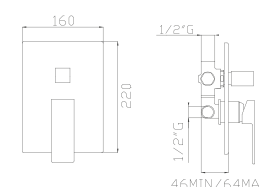

20188

Monocomando doccia incasso due uscite **con deviatore a pulsante**  
*Two-way concealed shower single lever mixer with push diverter*  
• 0,2730

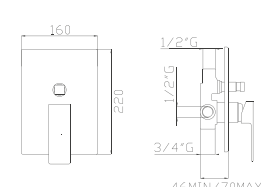

20189

Monocomando doccia incasso  
*Concealed shower single lever mixer*  
• 0,1308

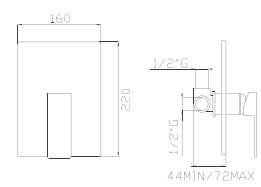



DOCCIA  
SHOWER

20186

Monocomando doccia  
incasso quattro uscite  
**non adattabile al  
sistema Uni-Box**  
Four way concealed  
shower single lever mixer  
**not suitable for Uni-Box  
system**  
• 0,3118

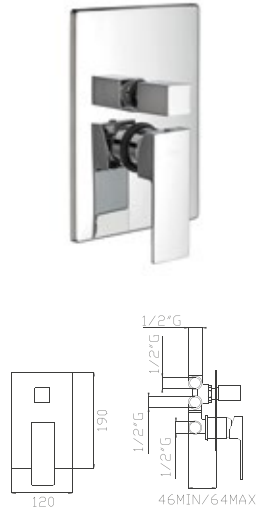

18387

Miscelatore termostatico  
doccia incasso tre uscite  
*Three-way concealed  
shower thermostatic  
mixer*  
• 0,7994

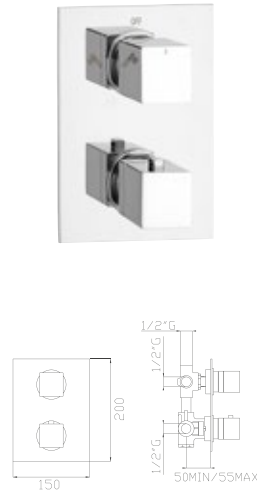

18388

Miscelatore termostatico  
doccia incasso due  
uscite  
*Two-way concealed  
shower thermostatic  
mixer*  
• 0,7773



18389

Miscelatore termostatico  
doccia incasso  
*Concealed shower  
thermostatic mixer*  
• 0,7041

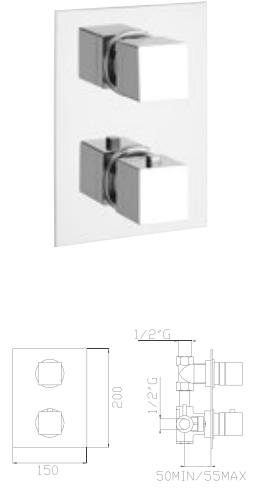

18347

Miscelatore termostatico  
doccia esterno con colonna,  
deviatore, flessibile Cromotech,  
soffione e doccia in ottone  
*Thermostatic external shower  
mixer with column, diverter,  
Cromotech flexible hose,  
brass showerhead and brass  
handshower*  
• 1,1784

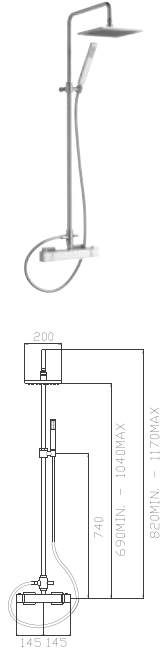

186-C6

Pres a d'acqua e doccia  
in ottone con flessibile  
Cromotech  
*Brass wall outlet with  
brass handshower and  
Cromotech flexible hose*  
• 0,1065



184-03

Pres a d'acqua in ottone  
*Brass water outlet*  
• 0,0296

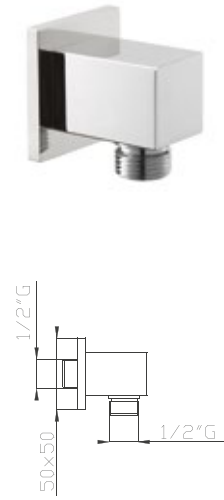

229

Saliscendi con asta e  
doccia in ottone con  
flessibile Cromotech  
*Brass sliding rail with  
brass handshower and  
Cromotech flexible hose*  
• 0,2456

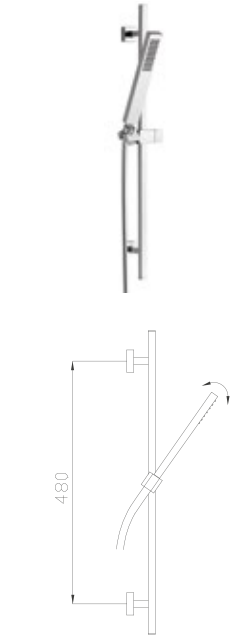

20149

Monocomando doccia  
esterno  
*Wall mounted shower  
single lever mixer*  
• 0,3110

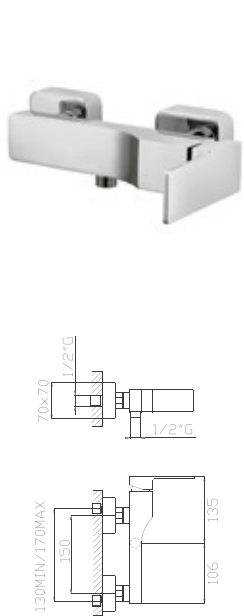

20147

Monocomando doccia esterno  
con colonna, deviatore,  
flessibile Cromotech,  
soffione e doccia in ottone  
*Wall mounted shower single  
lever mixer with column,  
diverter, Cromotech flexible  
hose, brass showerhead and  
brass handshower*  
• 0,8357

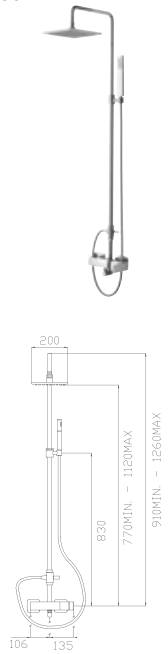

18344

Miscelatore termostatico  
doccia esterno  
*Thermostatic external  
shower mixer*  
• 0,6113

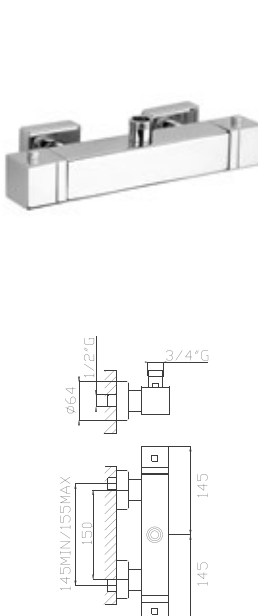

18349

Miscelatore termostatico  
doccia esterno  
*Thermostatic external  
shower mixer*  
• 0,5689

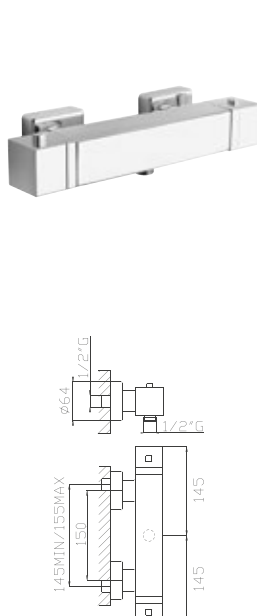

360

Soffione laterale esterno  
orientabile, in ottone  
*Brass external adjustable  
body jet*  
• 0,0445



363

Soffione laterale a parete  
orientabile in ABS  
*ABS wall adjustable  
body jet*  
• 0,0852

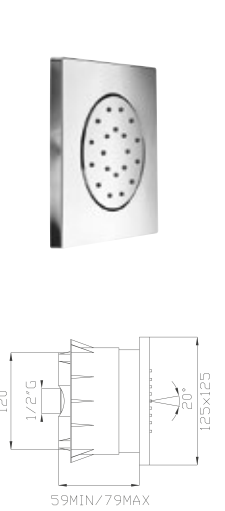

367

Soffione doccia in ottone  
con anticalcare  
*Brass shower head with  
antiscald*  
• 0,1546



376

Braccio doccia in ottone  
*Brass wall shower arm*  
• 0,0831



DOCCIA  
SHOWER





DOCCIA  
SHOWER

**377**

Braccio doccia a soffitto  
in ottone  
*Brass ceiling shower arm*  
• 0,0804

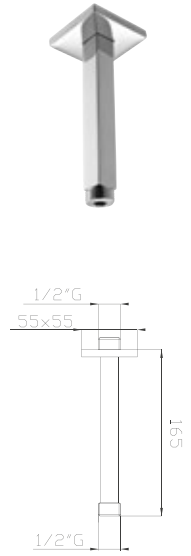

VASCA  
BATH

**20007**

Monocomando bordo  
vasca quattro fori  
*Four-hole deck mounted  
bath/shower single lever  
mixer*  
• 0,7623

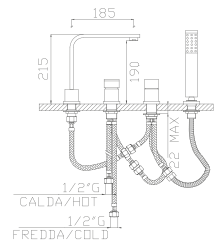

**20008**

Monocomando vasca  
con doccia duplex  
e flessibile Cromotech  
*Bath and shower single  
lever mixer with duplex  
and Cromotech flexible  
hose*  
• 0,3763

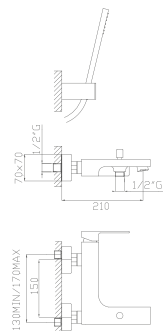

**612**

Bocca vasca a parete  
*Wall bath spout*  
• 0,2315

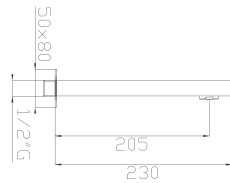

ACCESSORI  
ACCESSORIES

**442**

Sifone in ottone  
*Brass siphon*  
• 0,0848

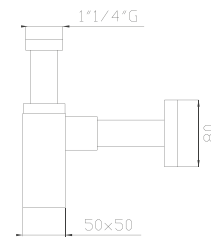

**953-05**

Tappo click-clack in  
ottone con troppo pieno  
*Brass click-clack plug  
with overflow*  
• 0,0548

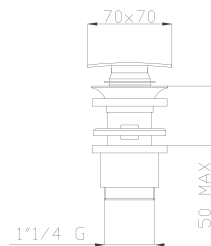

**953-06**

Tappo click-clack in  
ottone senza troppo  
pieno  
*Brass click-clack plug  
without overflow*  
• 0,0548

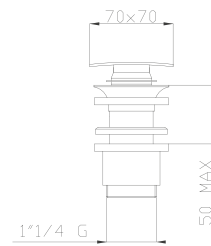

**884**

Rubinetto sottolavabo in  
ottone con filtro  
*Brass angle valve with  
strainer*  
• 0,0919

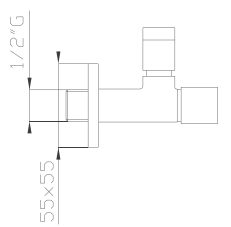



**BELINDA**



ART. 12034

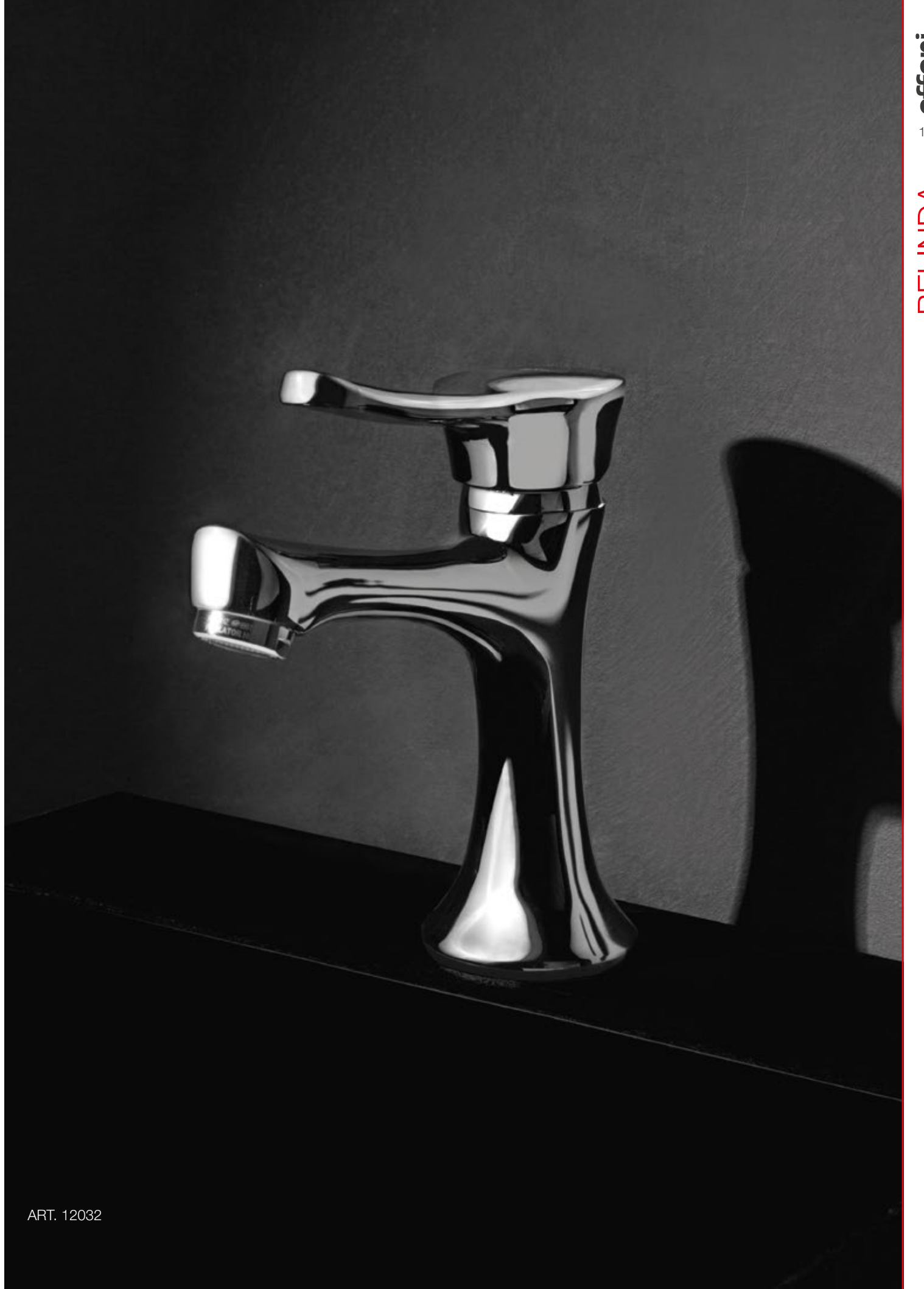

ART. 12032



ART. 12008

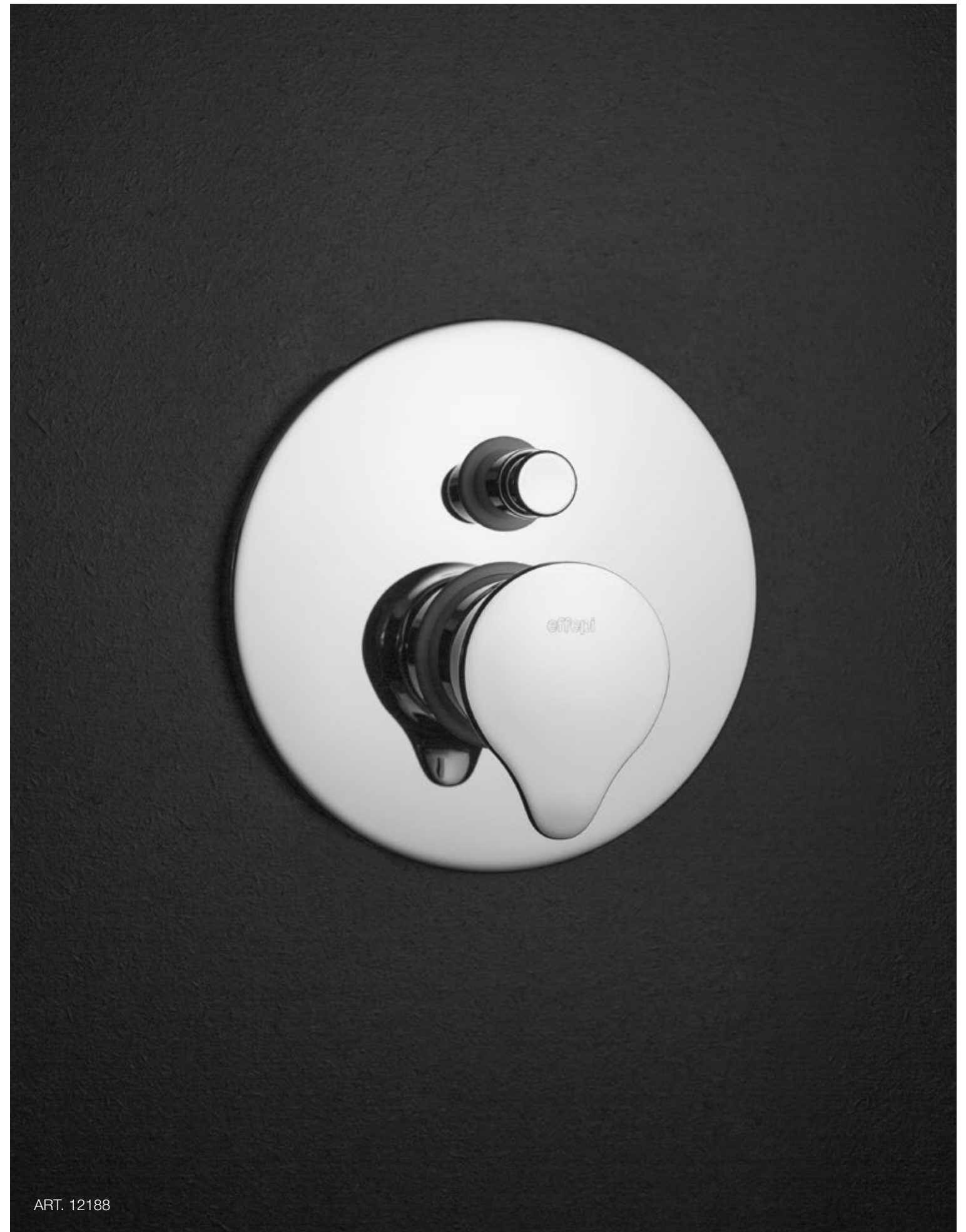

ART. 12188

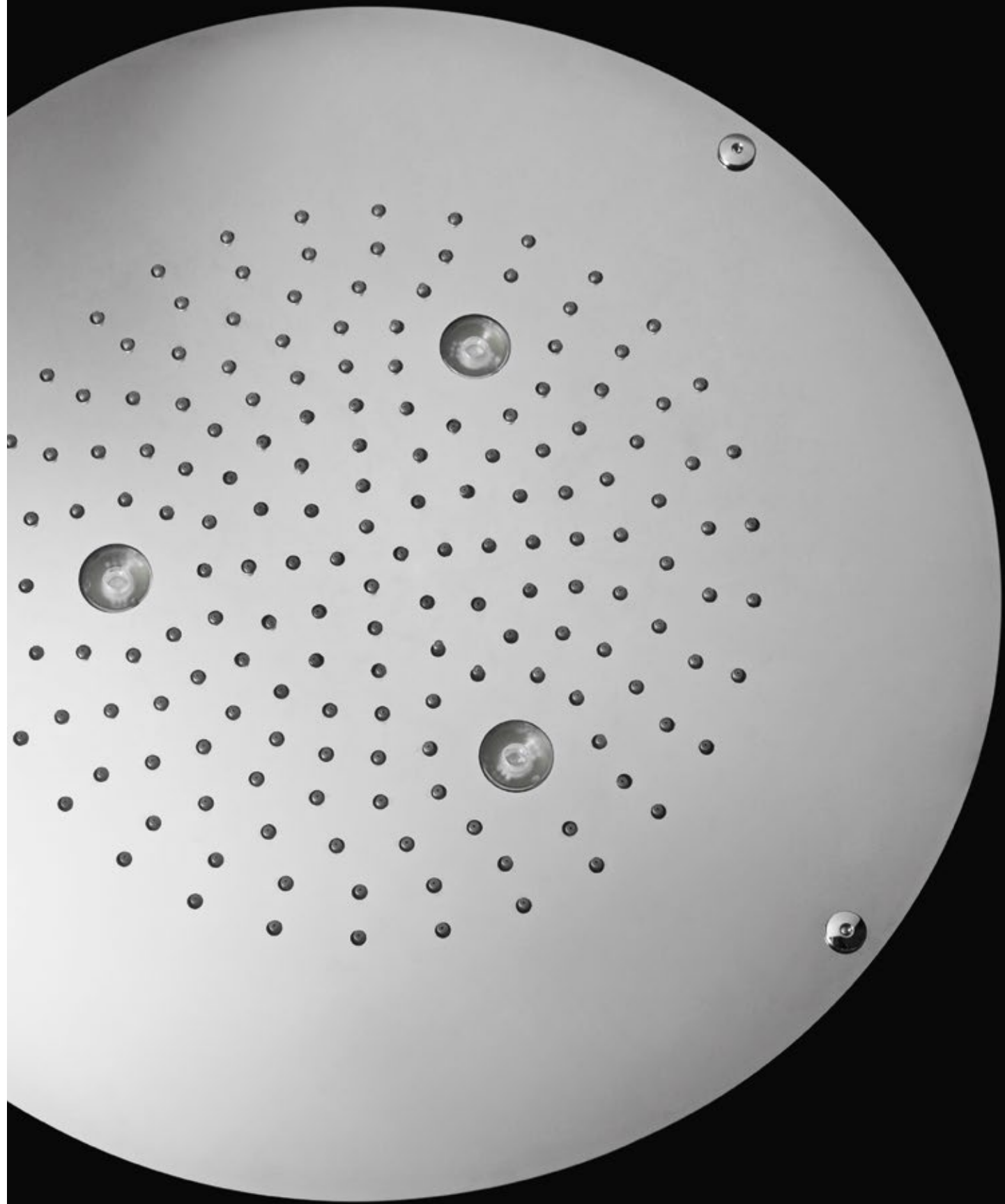

ART. 334-00



ART. 362

DOCCIA  
SHOWER

ADATTABILE AL SISTEMA **UNI-BOX**  
PER DETTAGLI VEDERE LISTINO PREZZI  
SUITABLE FOR **UNI-BOX** SYSTEM  
FOR FURTHER DETAILS SEE THE PRICE LIST



LAVABO / BIDET  
WASHBASIN / BIDET

**12188**

Monocomando doccia  
incasso due uscite **con  
deviatore a pulsante**  
*Two-way concealed  
shower single lever mixer  
with push diverter*  
• 0,1643



**12032**

Monocomando lavabo  
con scarico  
*Basin single lever mixer  
with pop-up waste*  
• 0,1413

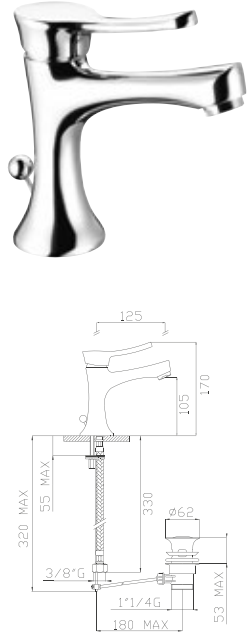

**12189**

Monocomando doccia  
incasso  
*Concealed shower single  
lever mixer*  
• 0,0937



**12034**

Monocomando lavabo  
ad incasso  
*Concealed basin single  
lever mixer*  
• 0,2598

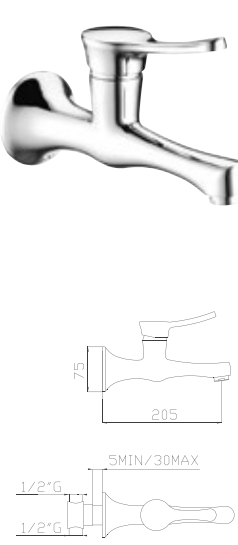

**12086**

Monocomando bidet con  
scarico  
*Bidet single lever mixer  
with pop-up waste*  
• 0,1413

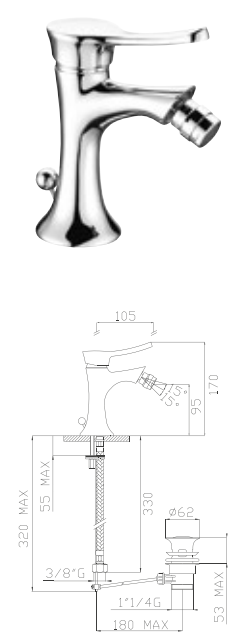

VASCA  
BATH

**12008**

Monocomando vasca  
con flessibile in ottone e  
doccia  
*Bath single lever mixer  
with brass flexible hose  
and handshower*  
• 0,3313

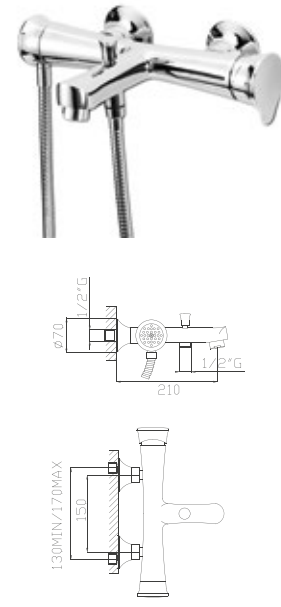

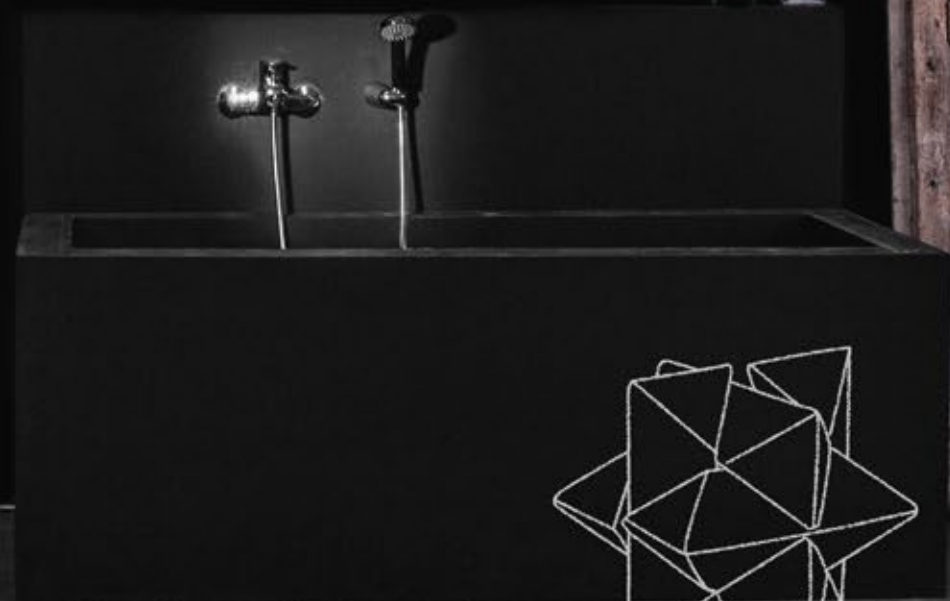
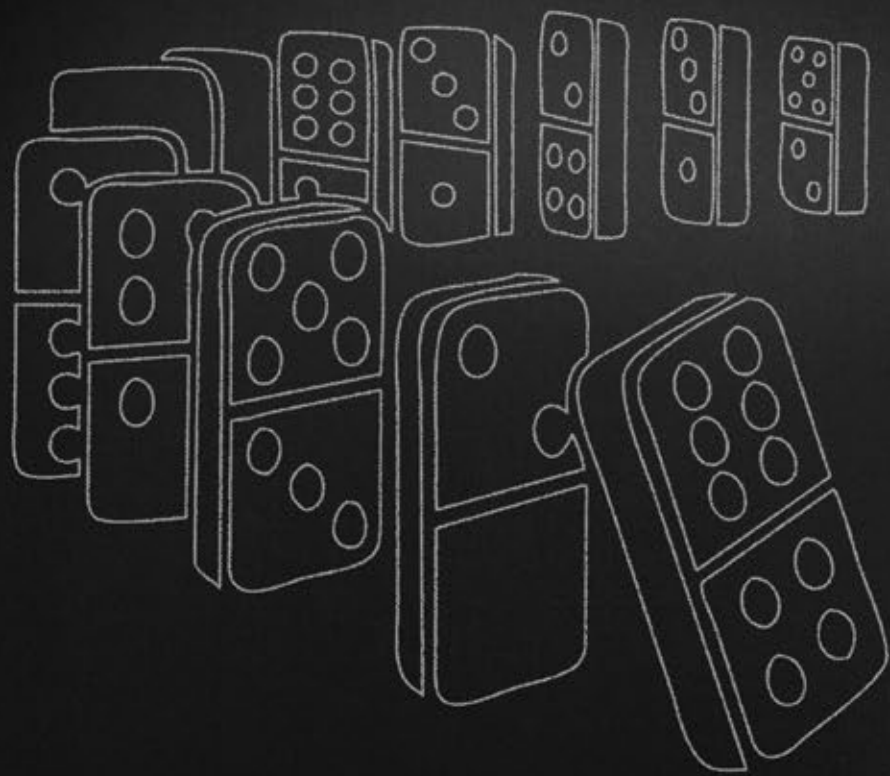

DOMINIO





ART. 8032



ART. 8086



ART. 8008



ART. 372-RI + ART. 367-30 + ART. 8189

DOCCIA  
SHOWER

ADATTABILE AL SISTEMA **UNI-BOX**  
PER DETTAGLI VEDERE LISTINO PREZZI  
SUITABLE FOR **UNI-BOX** SYSTEM  
FOR FURTHER DETAILS SEE THE PRICE LIST

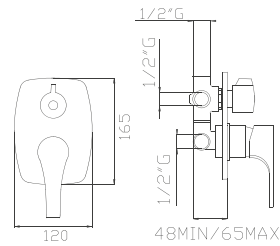

**8187**

Monocomando doccia  
incasso tre uscite  
*Three-way concealed  
shower single lever mixer*  
• 0,2333

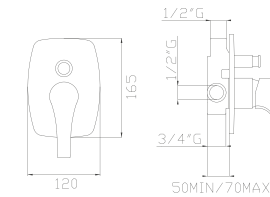

**8188**

Monocomando doccia  
incasso due uscite **con  
deviatore a pulsante**  
*Two-way concealed  
shower single lever mixer  
with push diverter*  
• 0,1573

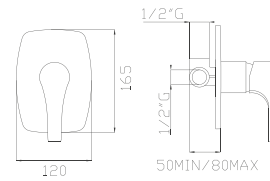

**8189**

Monocomando doccia  
incasso  
*Concealed shower single  
lever mixer*  
• 0,0858

LAVABO / BIDET  
WASHBASIN / BIDET

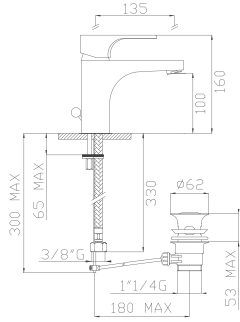

**8032**

Monocomando lavabo  
con scarico e **cartuccia  
doppio scatto\***  
*Basin single lever mixer  
with pop-up waste and  
double step cartridge\*\**  
• 0,1193

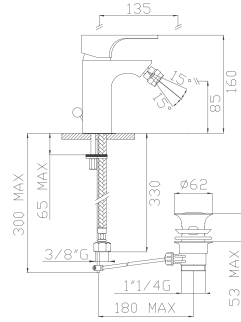

**8086**

Monocomando bidet  
con scarico e **cartuccia  
doppio scatto\***  
*Bidet single lever mixer  
with pop-up waste and  
double step cartridge\*\**  
• 0,1193

**\* PORTATA MEDIA 3 BAR**  
primo scatto 7L/min  
secondo scatto 12L/min

**\*\* AVERAGE FLOW RATE AT 3 BAR**  
first step 7L/min  
second step 12L/min

VASCA  
BATH

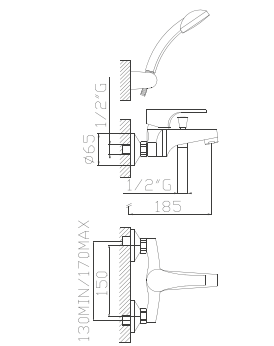

**8008**

Monocomando vasca  
con doccia duplex in  
ABS e flessibile in ottone  
*Bath and shower single  
lever mixer with ABS  
duplex and brass flexible  
hose*  
• 0,1476

DOCCIA  
SHOWER

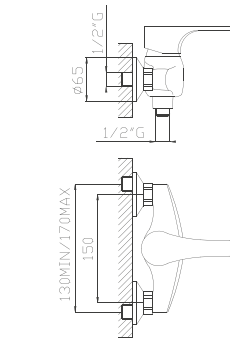

**8149**

Monocomando doccia  
esterno  
Wall mounted shower  
single lever mixer  
• 0,1078

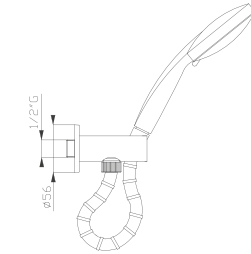

**186-07**

Preso d'acqua e flessibile  
in ottone con doccia in  
ABS tre getti  
*Brass wall outlet with  
brass flexible hose and  
ABS three-jet  
handshower*  
• 0,0645

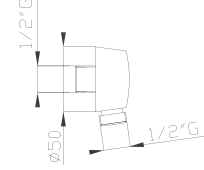

**184-01**

Preso d'acqua in ottone  
*Brass water outlet*  
• 0,0128

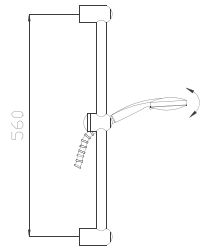

**239**

Saliscendi con asta e  
flessibile in ottone con  
doccia in ABS tre getti  
*Brass sliding rail with  
brass flexible hose and  
ABS three-jet  
handshower*  
• 0,0658





KAIROS



ART. 11032



ART. 11086



ART. 11188



ART. 238 + ART. 184-02 + ART. 11188 + ART. 372 + ART. 366



DOCCIA  
SHOWER

ADATTABILE AL SISTEMA **UNI-BOX**  
PER DETTAGLI VEDERE LISTINO PREZZI  
SUITABLE FOR **UNI-BOX** SYSTEM  
FOR FURTHER DETAILS SEE THE PRICE LIST

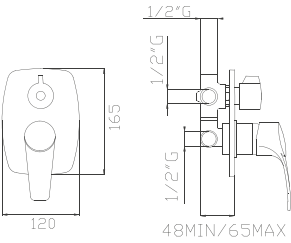

**11187**  
Monocomando doccia  
incasso tre uscite  
*Three-way concealed  
shower single lever mixer*  
• 0,2333

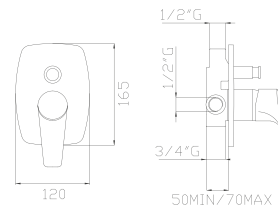

**11188**  
Monocomando doccia  
incasso due uscite **con  
deviatore a pulsante**  
*Two-way concealed  
shower single lever mixer  
with push diverter*  
• 0,1564

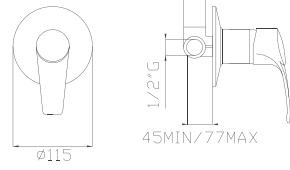

**11189**  
Monocomando doccia  
incasso  
*Concealed shower single  
lever mixer*  
• 0,0616

LAVABO / BIDET  
WASHBASIN / BIDET

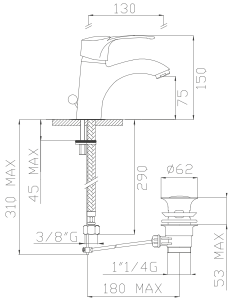

**11032**  
Monocomando lavabo  
con scarico  
*Basin single lever mixer  
with pop-up waste*  
• 0,0898

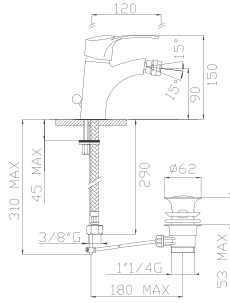

**11086**  
Monocomando bidet con  
scarico  
*Bidet single lever mixer  
with pop-up waste*  
• 0,0898

VASCA  
BATH

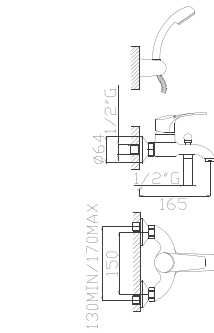

**11008**  
Monocomando vasca  
con doccia duplex in  
ABS e flessibile in ottone  
*Bath and shower single  
lever mixer with ABS  
duplex and brass flexible  
hose*  
• 0,1413

DOCCIA  
SHOWER

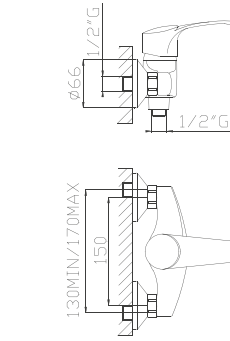

**11149**  
Monocomando doccia  
esterno  
*Wall mounted shower  
single lever mixer*  
• 0,0946

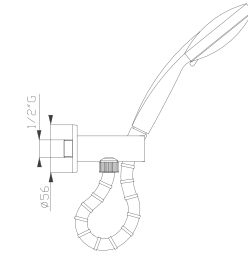

**186-07**  
Pres a d'acqua e flessibile  
in ottone con doccia in  
ABS tre getti  
*Brass wall outlet with  
brass flexible hose and  
ABS three-jet  
handshower*  
• 0,0645

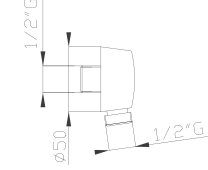

**184-01**  
Pres a d'acqua in ottone  
*Brass water outlet*  
• 0,0128

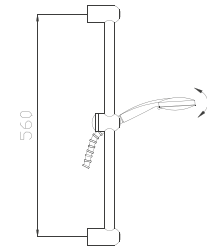

**239**  
Saliscendi con asta e  
flessibile in ottone con  
doccia in ABS tre getti  
*Brass sliding rail with  
brass flexible hose and  
ABS three-jet  
handshower*  
• 0,0658









ART. 22032



ART. 22008



ART. 225



ART. 22188



LAVABO / BIDET  
WASHBASIN / BIDET

**22032\***

Monocomando lavabo con scarico con cartuccia Eco-Start  
*Basin single lever mixer with pop-up waste with Eco-Start cartridge*  
• 0,0804

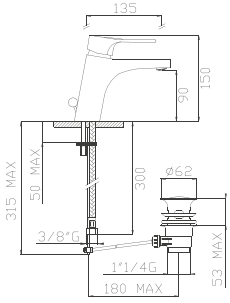

**22086\***

Monocomando bidet con scarico con cartuccia Eco-Start  
*Bidet single lever mixer with pop-up waste with Eco-Start cartridge*  
• 0,0804

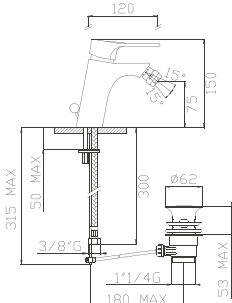

\*



**CALCOLI ESEGUITI\*:**  
Campione famiglia composta da 4 persone  
Periodo 1 anno

**CALCOLO UTILIZZO ACQUA:**  
Acqua utilizzata senza ECO DROP con erogazione a 12L/min 27.000 litri  
Acqua utilizzata con sistema ECO DROP con erogazione a 7L/min 15.750 litri

**CALCOLO ATTIVAZIONI NON NECESSARIE DEL SISTEMA DI RISCALDAMENTO ACQUA:**  
Rubinetto senza ECO ENERGY 4.500 Start  
Rubinetto con ECO ENERGY 0 Start

**DATA BASED ON\*\*:**  
4 people average family  
Period of 1 year

**WATER CONSUMPTION :**  
Without ECO DROP System (12 liters water supply) 27.000 liters a year  
With ECO DROP System (7 liters water supply) 15.750 liters a year

**UNNECESSARY ACTUATIONS OF WATER HEATING SYSTEM:**  
Mixer without ECO ENERGY System 4.500 Actuations  
Mixer with ECO ENERGY System 0 Actuations

\* Dati elaborati dallo studio tecnico Effepi e rilevati da fonti web  
\*\* Data developed by Effepi R&D department plus web sources

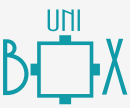

ADATTABILE AL SISTEMA **UNI-BOX**  
PER DETTAGLI VEDERE LISTINO PREZZI  
SUITABLE FOR **UNI-BOX** SYSTEM  
FOR FURTHER DETAILS SEE THE PRICE LIST

**22187**

Monocomando doccia incasso tre uscite  
*Three-way concealed shower single lever mixer*  
• 0,2315

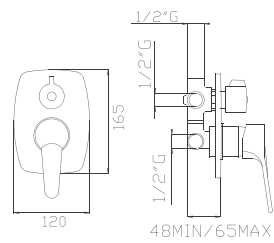

**22188**

Monocomando doccia incasso due uscite con deviatore a pulsante  
*Two-way concealed shower single lever mixer with push diverter*  
• 0,1555

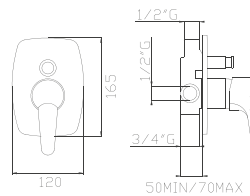

**22189**

Monocomando doccia incasso  
*Concealed shower single lever mixer*  
• 0,0601

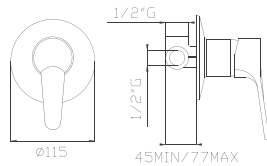

DOCCIA  
SHOWER

**22149**

Monocomando doccia esterno  
*Wall mounted shower single lever mixer*  
• 0,0946

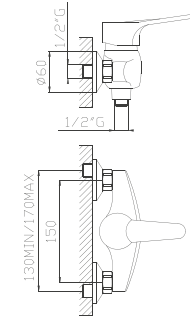

**186-07**

Preso d'acqua e flessibile in ottone con doccia in ABS tre getti  
*Brass wall outlet with brass flexible hose and ABS three-jet handshower*  
• 0,0645



**184-01**

Preso d'acqua in ottone  
*Brass water outlet*  
• 0,0128

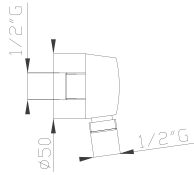
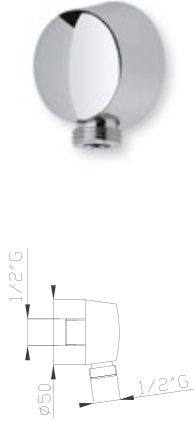

**239**

Saliscendi con asta e flessibile in ottone con doccia in ABS tre getti  
*Brass sliding rail with brass flexible hose and ABS three-jet handshower*  
• 0,0658

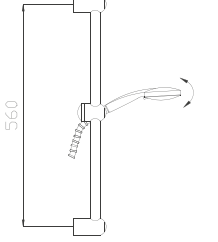
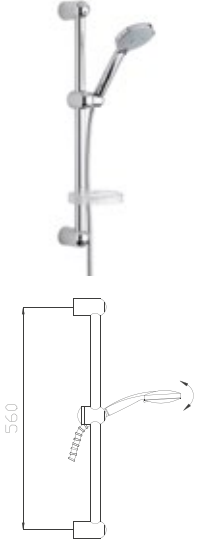

**22008**

Monocomando vasca con doccia duplex in ABS e flessibile in ottone  
*Bath and shower single lever mixer with ABS duplex and brass flexible hose*  
• 0,1067

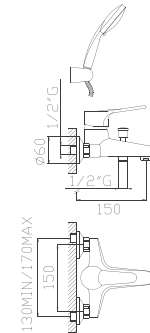

DOCCIA  
SHOWER



“

**ELEGANZA  
TRADIZIONALE**

”

“

***TRADITIONAL  
ELEGANCE***

”

CHIC 70CENTO





ART. 43034



ART. 43007



ART. 43184

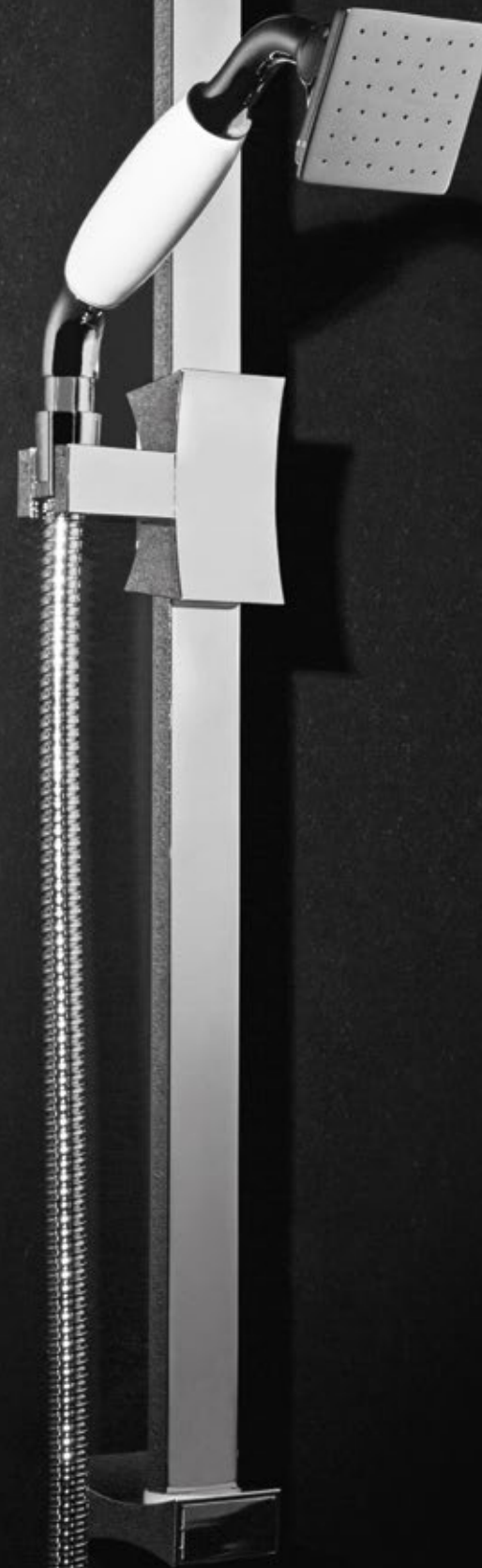

ART. 231



ART. 45037



ART. 45016





ART. 44034

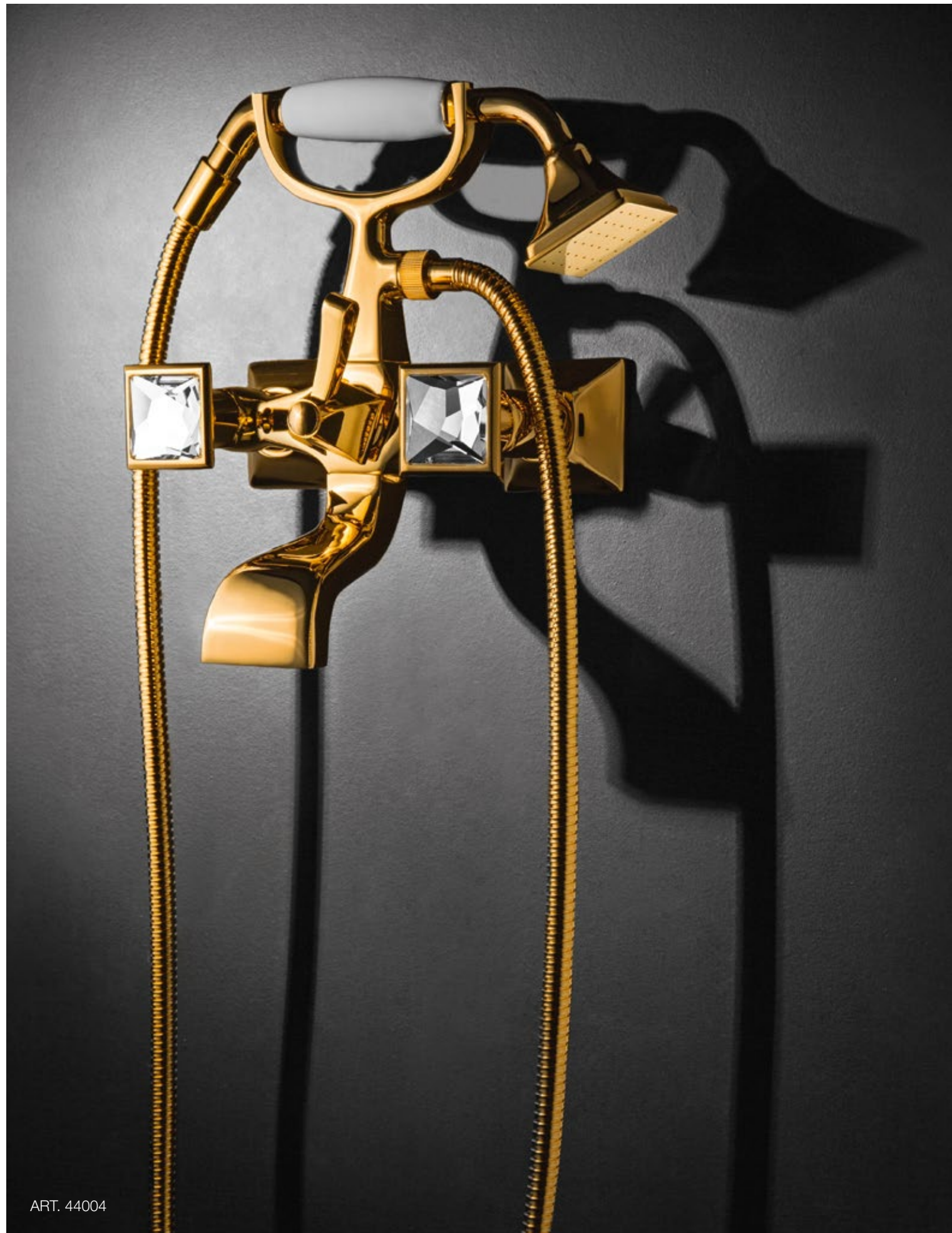

ART. 44004

DOCCIA  
SHOWER

LAVABO / BIDET  
WASHBASIN / BIDET

**42189**

Monocomando doccia  
incasso  
*Concealed shower single  
lever mixer*  
• 0,1087



**43037**

Batteria lavabo tre fori  
con scarico  
*Three-hole basin mixer  
with pop-up waste*  
• 0,5300

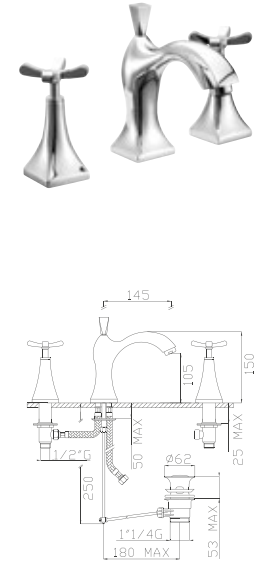

**43181**

Gruppo incasso doccia  
**tre uscite**  
*Three-way concealed  
shower mixer*  
• 0,4692

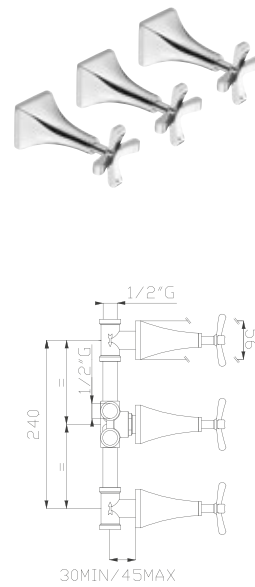

**43034**

Gruppo lavabo ad  
incasso  
*Concealed basin mixer*  
• 0,5150

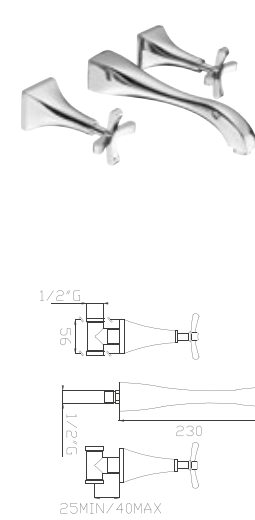

**43182**

Gruppo incasso doccia  
**due uscite**  
*Two-way concealed  
shower mixer*  
• 0,4350

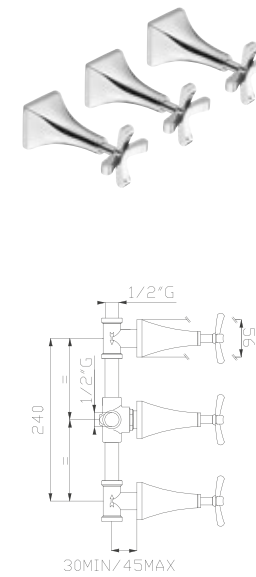

**43061**

Batteria bidet tre fori con  
scarico  
*Three-hole bidet mixer  
with pop-up waste*  
• 0,4612

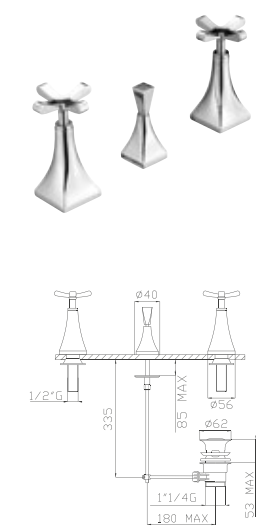

**43184**

Rubinetti incasso doccia  
*Concealed shower taps*  
• 0,2792

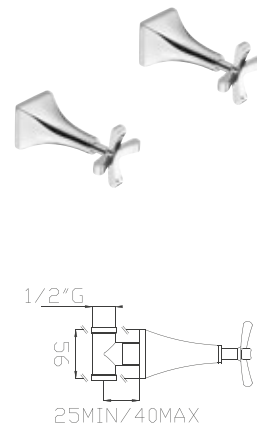

**43081**

Batteria bidet tre fori con  
scarico  
*Three-hole bidet mixer  
with pop-up waste*  
• 0,5300

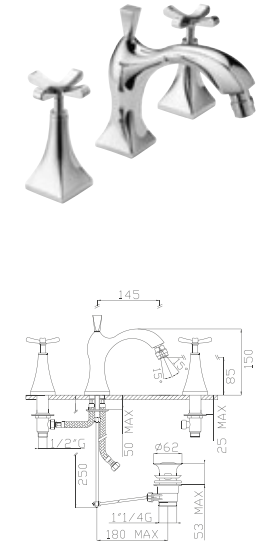

VASCA  
BATH

DOCCIA  
SHOWER

**43004**

Gruppo vasca con  
doccia e flessibile in  
ottone  
*Bath/shower mixer with  
brass handshower and  
brass flexible hose*  
• 0,6864

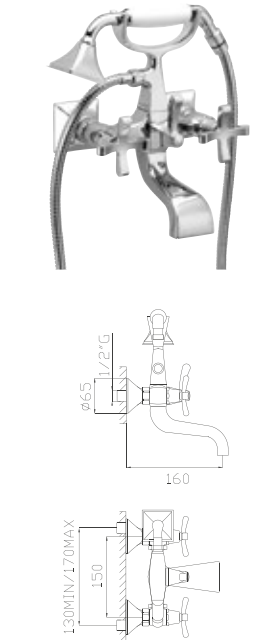

**43149**

Gruppo doccia esterno  
*Wall mounted shower  
mixer*  
• 0,1484

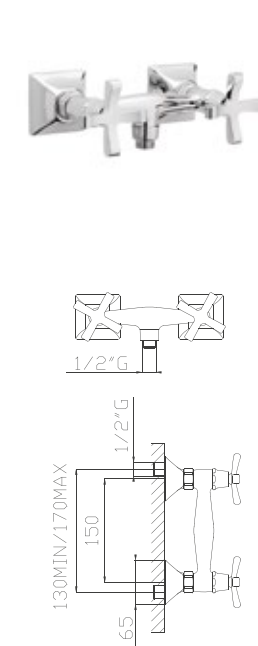

**43007**

Gruppo bordo vasca  
quattro fori  
*Four-hole deck mounted  
bath/shower mixer*  
• 0,8171

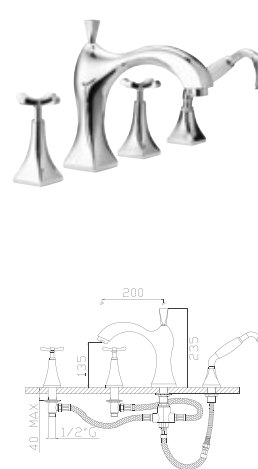

**186-10**

Presa d'acqua con  
doccia e flessibile, in  
ottone  
*Brass wall outlet with  
handshower and flexible  
hose*  
• 0,1097

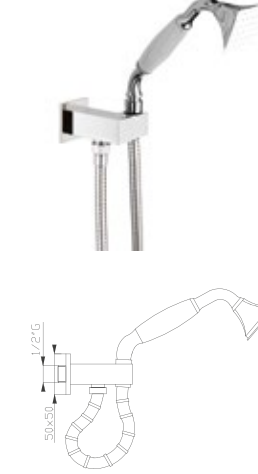

**43016**

Gruppo vasca con  
colonne a pavimento  
*Bathtub mixer with floor  
columns*  
• 0,9823

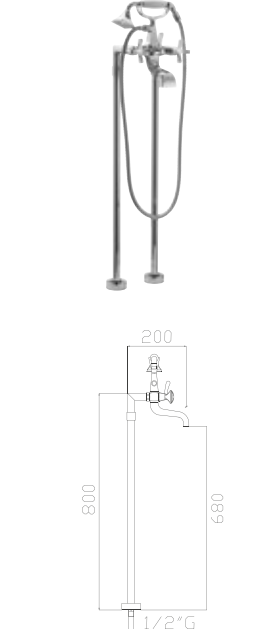

**184-03**

Presa d'acqua in ottone  
*Brass water outlet*  
• 0,0296

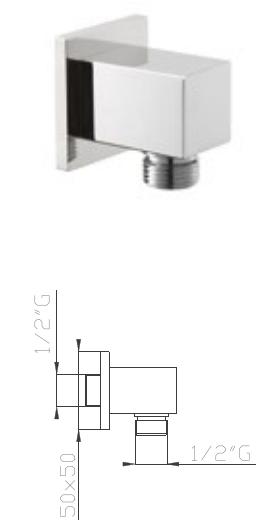

**604**

Bocca vasca a parete  
*Wall bath spout*  
• 0,2023



**231**

Saliscendi con asta  
flessibile e doccia in  
ottone  
*Brass sliding rail with  
flexible hose and brass  
handshower*  
• 0,1705

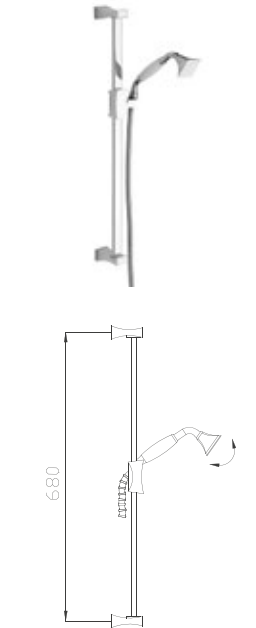

DOCCIA  
SHOWER

LAVABO / BIDET  
WASHBASIN / BIDET



**42189**  
Monocomando doccia incasso  
*Concealed shower single lever mixer*  
• 0,1087

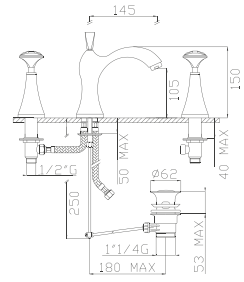

**44037**  
Batteria lavabo tre fori con scarico e maniglia Swarovski  
*Three-hole basin mixer with pop-up waste and Swarovski handle*  
• 0,6899

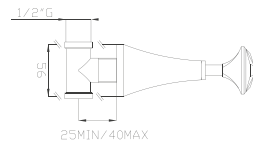

**44184**  
Rubinetti incasso doccia con maniglia Swarovski  
*Concealed shower taps with Swarovski handle*  
• 0,4391

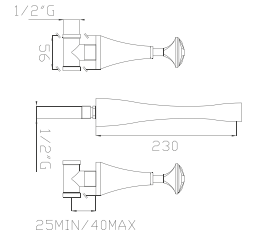

**44034**  
Gruppo lavabo ad incasso con maniglia Swarovski  
*Concealed basin mixer with Swarovski handle*  
• 0,6740

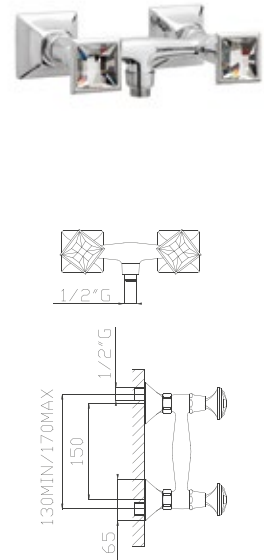

**44149**  
Gruppo doccia esterno con maniglia Swarovski  
*Wall mounted shower mixer with Swarovski handle*  
• 0,3339

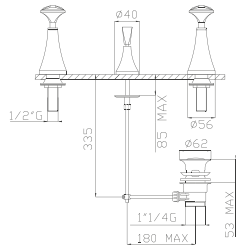

**44061**  
Batteria bidet tre fori con scarico e maniglia Swarovski  
*Three-hole bidet mixer with pop-up waste and Swarovski handle*  
• 0,6202



**186-10**  
Pres a d'acqua con doccia e flessibile, in ottone  
*Brass wall outlet with handshower and flexible hose*  
• 0,1097

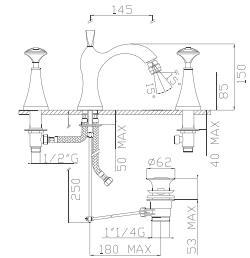

**44081**  
Batteria bidet tre fori con scarico e maniglia Swarovski  
*Three-hole bidet mixer with pop-up waste and Swarovski handle*  
• 0,6899

VASCA  
BATH

DOCCIA  
SHOWER

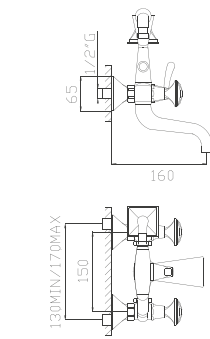

**44004**  
Gruppo vasca con doccia e flessibile in ottone e maniglia Swarovski  
*Bath/shower mixer with brass handshower and brass flexible hose and Swarovski handle*  
• 0,8993



**44007**  
Gruppo bordo vasca quattro fori con maniglia Swarovski  
*Four-hole deck mounted bath/shower mixer with Swarovski handle*  
• 0,9761

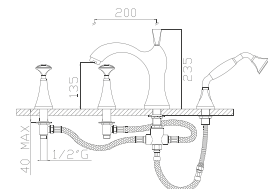

**44016**  
Gruppo vasca con colonne a pavimento e maniglia Swarovski  
*Bathtub mixer with floor columns and Swarovski handle*  
• 1,1961



**231**  
Saliscendi con asta flessibile e doccia in ottone  
*Brass sliding rail with flexible hose and brass handshower*  
• 0,1705

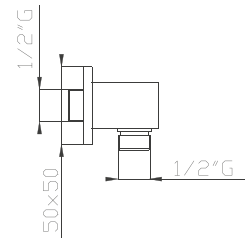

**184-03**  
Pres a d'acqua in ottone  
*Brass water outlet*  
• 0,0296

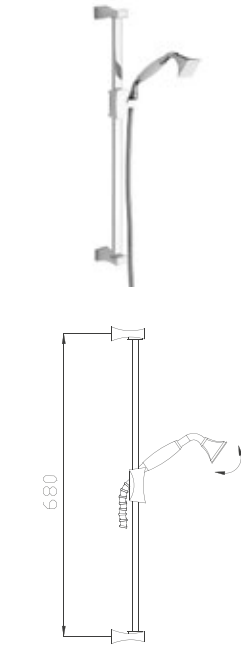

**604**  
Bocca vasca a parete  
*Wall bath spout*  
• 0,2023

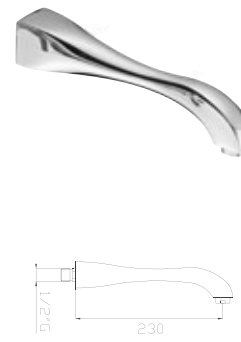

**604**  
Bocca vasca a parete  
*Wall bath spout*  
• 0,2023

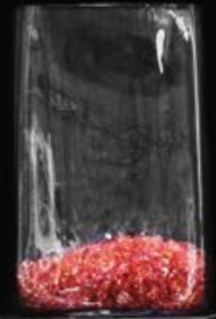

CRISTAL



ART. 23037



ART. 23007



ART. 23184 + ART. 23027 + ART. 184-D2 + ART. 227 + ART. 372 + ART. 364



ART. 23184



ART. 184-D2 + ART. 227



ART. 372 + ART. 364

LAVABO / BIDET  
WASHBASIN / BIDET

**23037**

Batteria lavabo tre fori con scarico e maniglia Swarovski  
*Three-hole basin mixer with pop-up waste and Swarovski handle*

- 1,5918

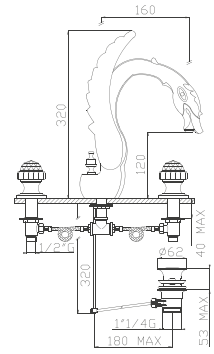

**23081**

Batteria bidet tre fori con scarico e maniglia Swarovski  
*Three-hole bidet mixer with pop-up waste and Swarovski handle*

- 1,1855

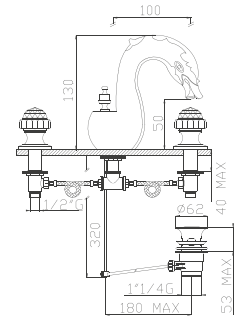

**23184**

Rubinetti incasso doccia con maniglia Swarovski  
*Concealed shower taps with Swarovski handle*

- 0,6334

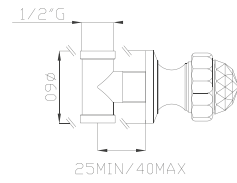

**23149**

Gruppo doccia esterno con maniglia Swarovski  
*Wall mounted shower mixer with Swarovski handle*

- 0,9708

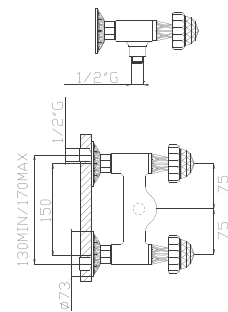

**227**

Saliscendi con asta flessibile e doccia in ottone con maniglia Swarovski  
*Brass sliding rail with flexible hose and hand shower with Swarovski handle*

- 0,5513

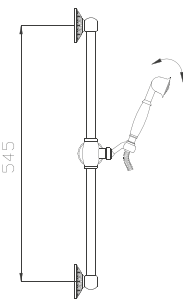

DOCCIA  
SHOWER

VASCA  
BATH

**23007**

Gruppo bordo vasca cinque fori con maniglia Swarovski  
*Five-hole deck mounted bath/shower mixer with Swarovski handle*

- 1,8851

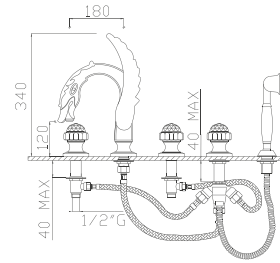



ARTEX & ERICE

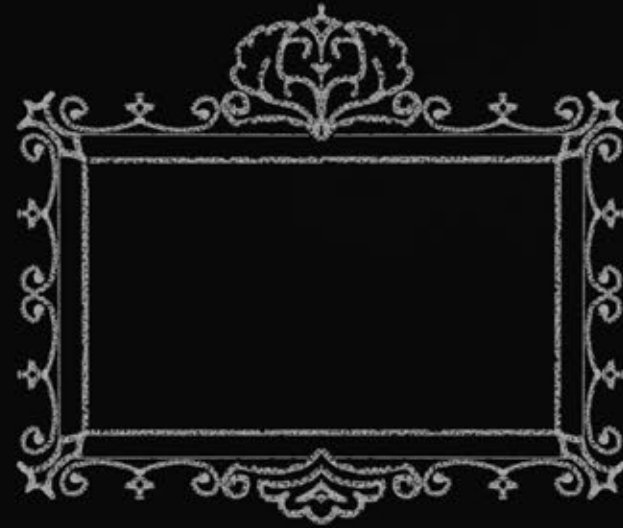



ART. 6036



ART. 6081



ART. 6031

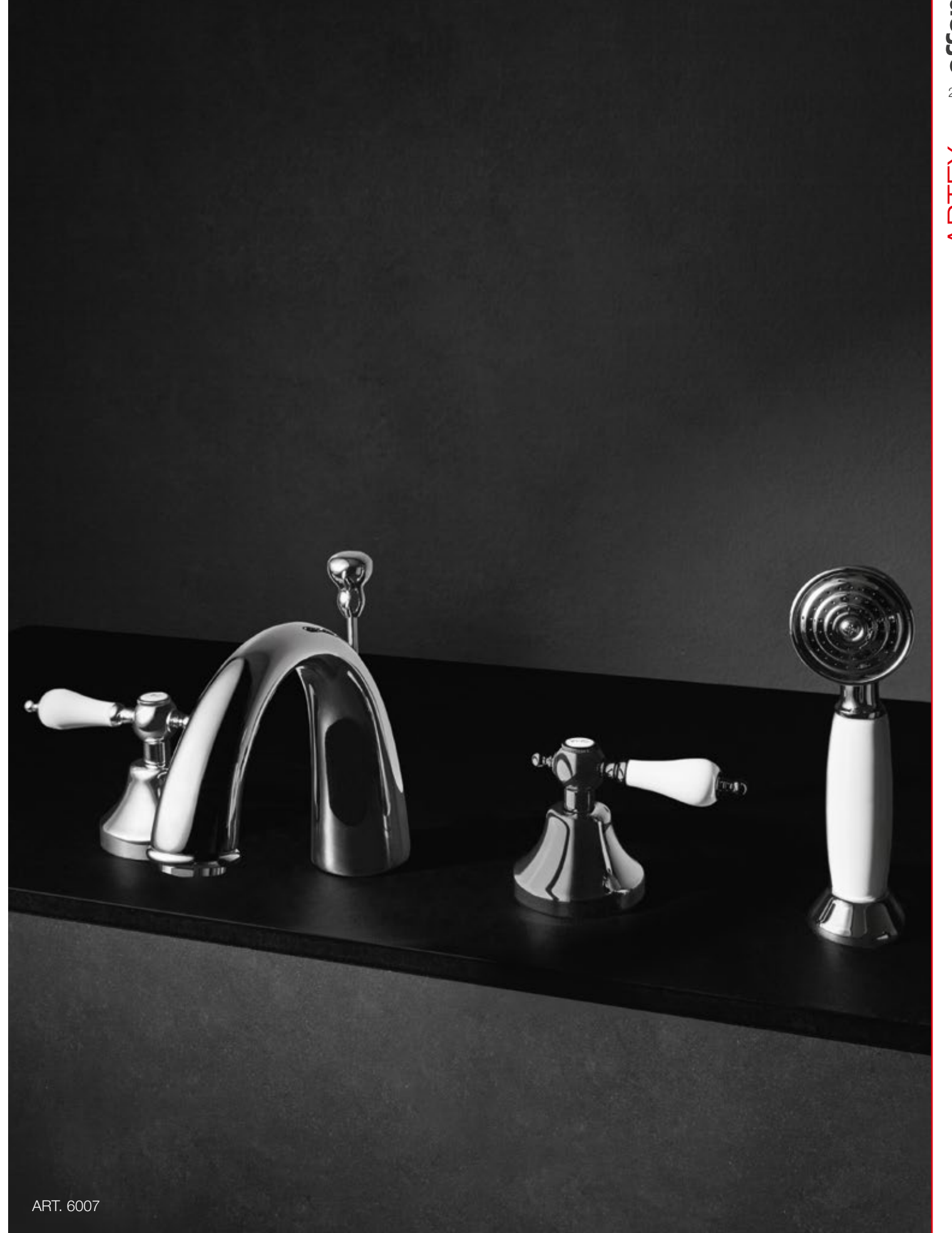

ART. 6007



ART. 10184 + ART. 10021 + ART. 186-12

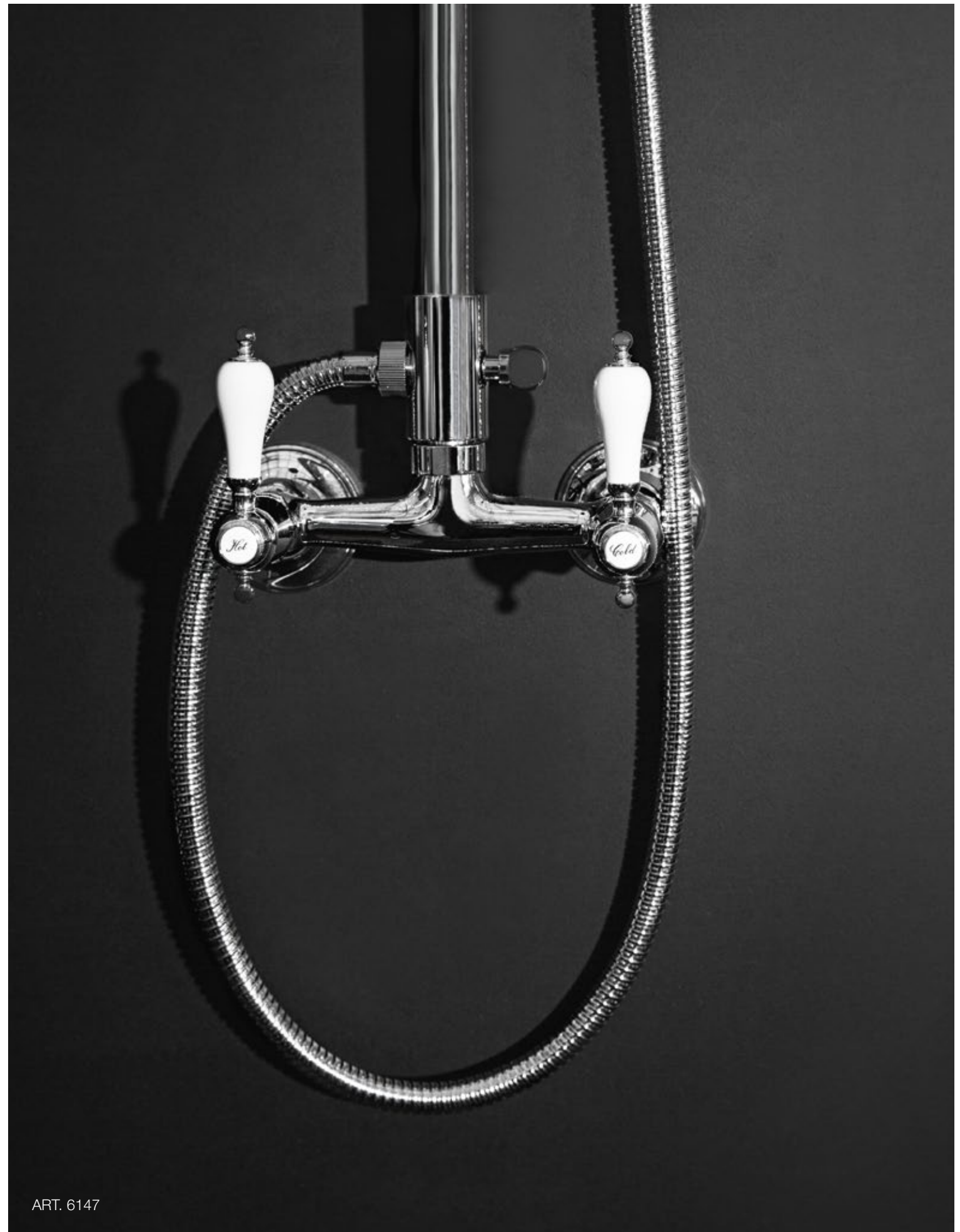

ART. 6147



ART. 10036

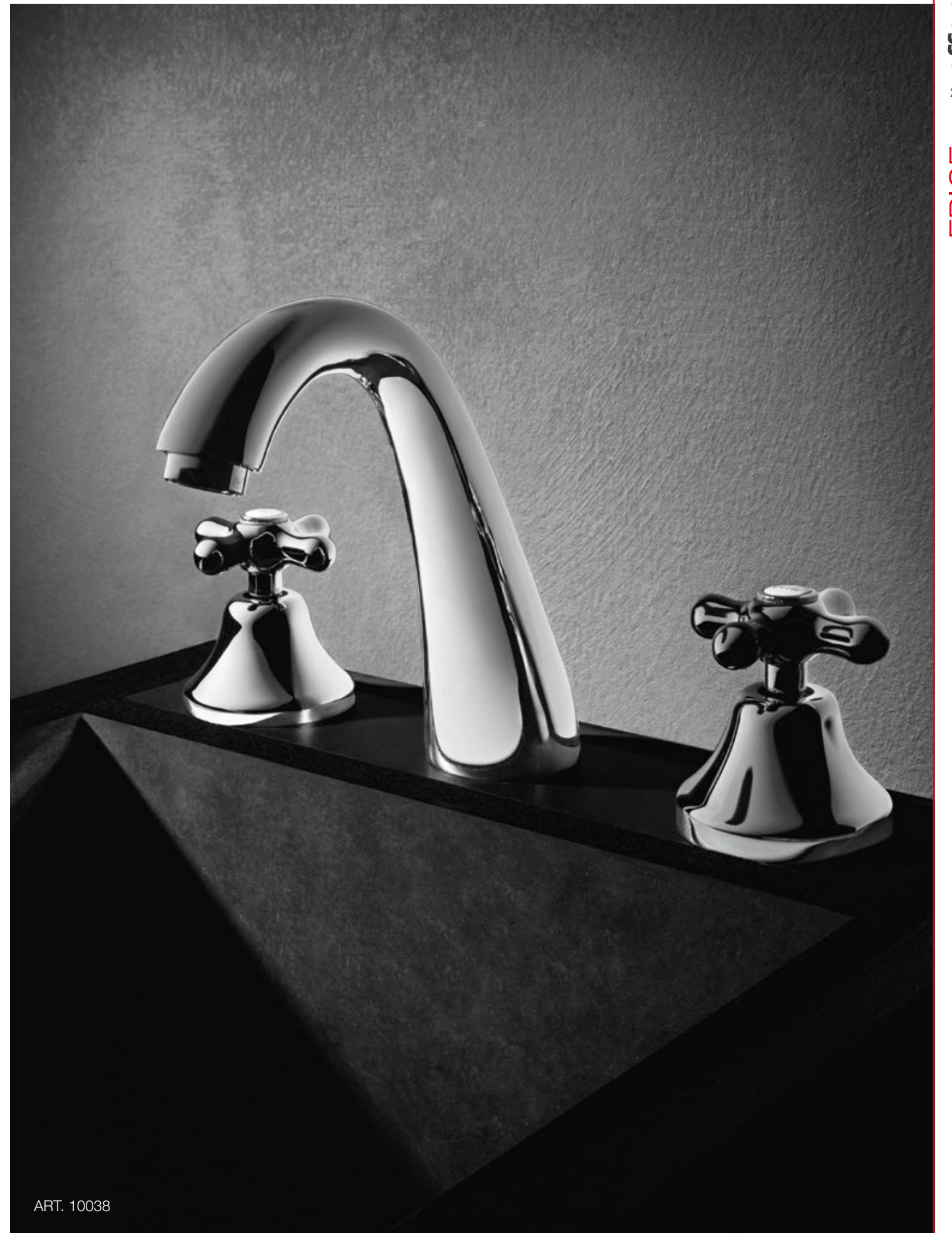

ART. 10038



LAVABO / BIDET  
WASHBASIN / BIDET

**6031**

Monoforo lavabo con scarico  
*Single hole basin mixer with pop-up waste*  
• 0,2200

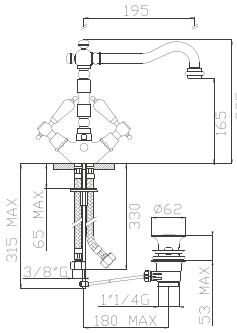

**6081**

Batteria bidet tre fori con scarico  
*Three-hole bidet mixer with pop-up waste*  
• 0,2738

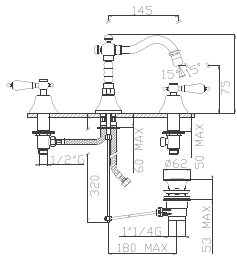

**6036**

Batteria lavabo tre fori con scarico  
*Three-hole basin mixer with pop-up waste*  
• 0,2738

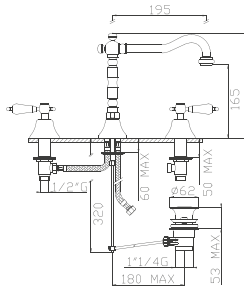

**6085**

Monoforo bidet con scarico  
*Single hole bidet mixer with pop-up waste*  
• 0,2200

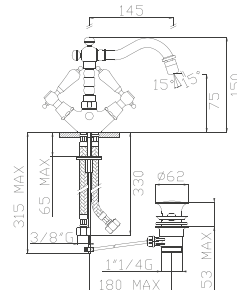

**6061**

Batteria bidet tre fori con scarico  
*Three-hole bidet mixer with pop-up waste*  
• 0,1413

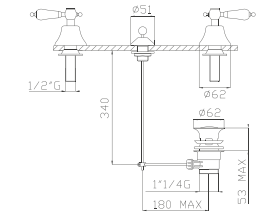

DOCCIA  
SHOWER

**6189**

Monocomando doccia incasso  
*Concealed shower single lever mixer*  
• 0,0990

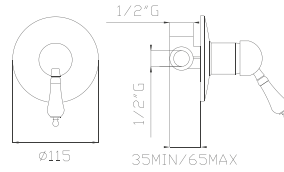

**364**

Soffione doccia in ottone con anticalcare  
*Brass shower head with antiscala*  
• 0,1678

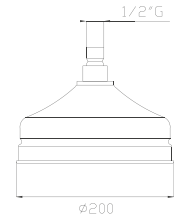

**186-09**

Preso d'acqua con doccia e flessibile, in ottone  
*Brass wall outlet with handshower and flexible hose*  
• 0,0778

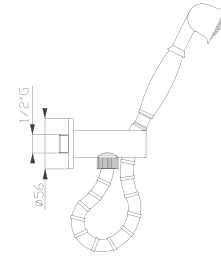

**372**

Braccio doccia in ottone  
*Brass wall shower arm*  
• 0,0389

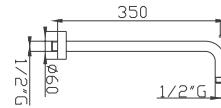

**184-01**

Preso d'acqua in ottone  
*Brass water outlet*  
• 0,0128

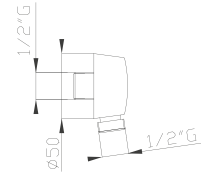

**241**

Saliscendi con asta flessibile e doccia in ottone  
*Brass sliding rail with flexible hose and handshower*  
• 0,2085

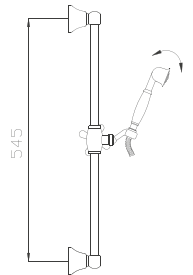



VASCA  
BATH

**6007**

Gruppo bordo vasca  
quattro fori  
*Four-hole deck mounted  
bath/shower mixer*  
• 0,3967

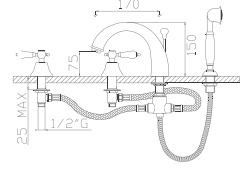

**6008**

Gruppo vasca con  
doccia e flessibile in  
ottone  
*Bath mixer with brass  
handshower and brass  
flexible hose*  
• 0,2668

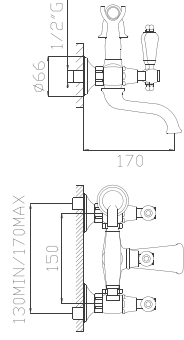

**603**

Bocca vasca a parete  
*Wall bath spout*  
• 0,0998

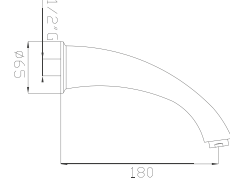



LAVABO / BIDET  
WASHBASIN / BIDET

**10031**

Monoforo lavabo con scarico  
*Single hole basin mixer with pop-up waste*  
• 0,2076

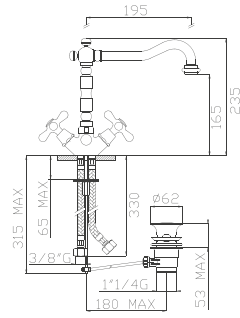

**10032**

Monoforo lavabo con scarico  
*Single hole basin mixer with pop-up waste*  
• 0,1405

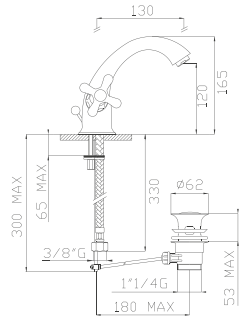

**10036**

Batteria lavabo tre fori con scarico  
*Three-hole basin mixer with pop-up waste*  
• 0,2721

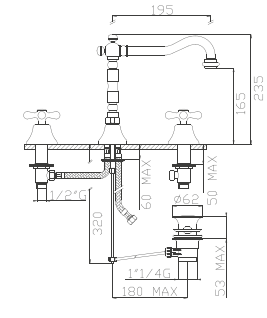

**10037**

Batteria lavabo tre fori con scarico  
*Three-hole basin mixer with pop-up waste*  
• 0,2183

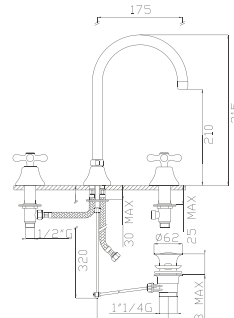

LAVABO / BIDET  
WASHBASIN / BIDET

**10061**

Batteria bidet tre fori con scarico  
*Three-hole bidet mixer with pop-up waste*  
• 0,1113

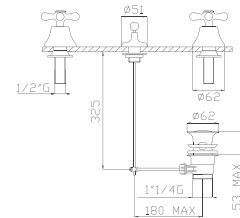

**10071**

Batteria bidet tre fori con scarico  
*Three-hole bidet mixer with pop-up waste*  
• 0,1908

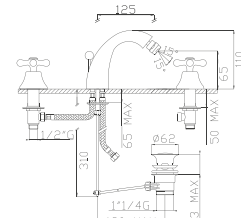

**10081**

Batteria bidet tre fori con scarico  
*Three-hole bidet mixer with pop-up waste*  
• 0,2721

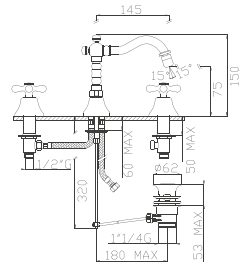

**10038**

Batteria lavabo tre fori con scarico  
*Three-hole basin mixer with pop-up waste*  
• 0,1908

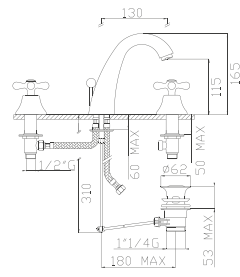

**10034**

Gruppo lavabo ad incasso  
*Concealed basin mixer*  
• 0,2600

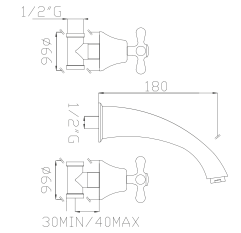

**10085**

Monoforo bidet con scarico  
*Single hole bidet mixer with pop-up waste*  
• 0,2076

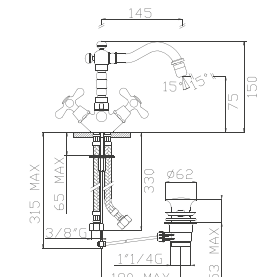

**10086**

Monoforo bidet con scarico  
*Single hole bidet mixer with pop-up waste*  
• 0,1405

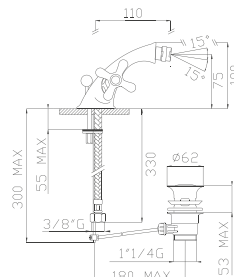

DOCCIA  
SHOWER

**10181**

Gruppo incasso doccia tre uscite  
*Three-way concealed shower mixer*  
• 0,3017

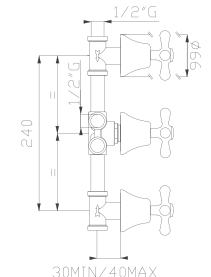

**10182**

Gruppo incasso doccia due uscite  
*Two-way concealed shower mixer*  
• 0,2725

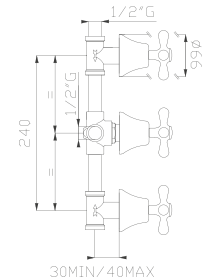

**10184**

Rubinetti incasso doccia  
*Concealed shower taps*  
• 0,0933

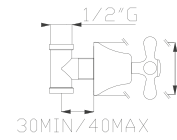

**10189**

Monocomando doccia incasso  
*Concealed shower single lever mixer*  
• 0,0937

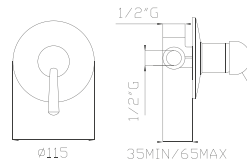



DOCCIA  
SHOWER

**10149**

Gruppo doccia esterno  
*Wall mounted shower mixer*  
• 0,1131

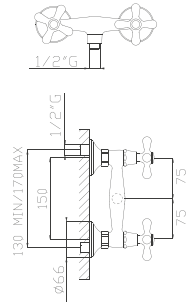

**10147**

Gruppo doccia esterno con  
colonna, deviatore, soffione,  
flessibile e doccia in ottone  
*Wall mounted shower mixer  
with column, diverter,  
brass shower head, brass  
flexible hose and brass  
handshower*  
• 0,6511

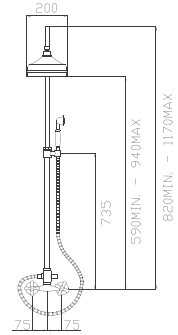

**186-09**

Preso d'acqua con  
doccia e flessibile, in  
ottone  
*Brass wall outlet with  
handshower and flexible  
hose*  
• 0,0778

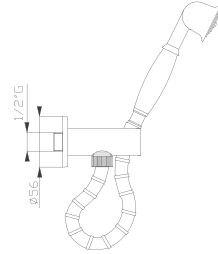

**184-01**

Preso d'acqua in ottone  
*Brass water outlet*  
• 0,0128

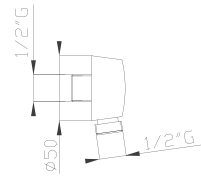

VASCA  
BATH

**10007**

Gruppo bordo vasca  
quattro fori  
*Four-hole deck mounted  
bath/shower mixer*  
• 0,3790

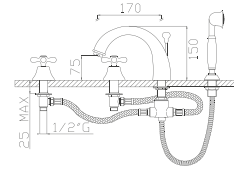

**10008**

Gruppo vasca con  
doccia e flessibile in  
ottone  
*Bath mixer with brass  
handshower and brass  
flexible hose*  
• 0,2536

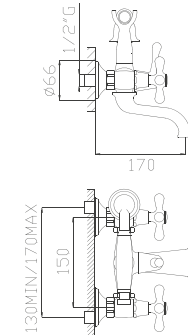

**603**

Bocca vasca a parete  
*Wall bath spout*  
• 0,0998

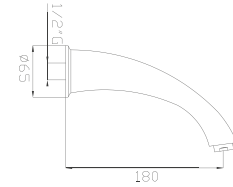

**241**

Saliscendi con asta  
flessibile e doccia in  
ottone  
*Brass sliding rail with  
flexible hose and  
handshower*  
• 0,2085

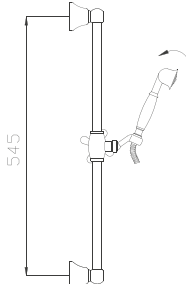

**364**

Soffione doccia in ottone  
con anticalcare  
*Brass shower head with  
antiscala*  
• 0,1678

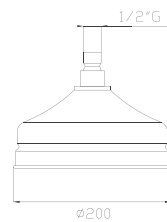

**372**

Braccio doccia in ottone  
*Brass wall shower arm*  
• 0,0389

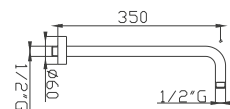



CHIC



ART. 42032



ART. 42007



ART. 231 + ART. 372-RI + ART. 367-30



ART. 42188



DOCCIA  
SHOWER

ADATTABILE AL SISTEMA **UNI-BOX**  
PER DETTAGLI VEDERE LISTINO PREZZI  
SUITABLE FOR **UNI-BOX** SYSTEM  
FOR FURTHER DETAILS SEE THE PRICE LIST

LAVABO / BIDET  
WASHBASIN / BIDET

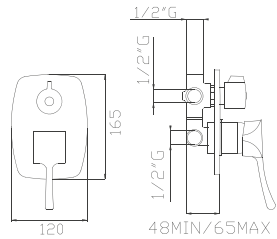

**42187**  
Monocomando doccia  
incasso tre uscite  
*Three-way concealed  
shower single lever mixer*  
• 0,2536

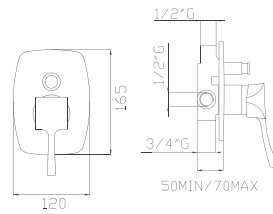

**42188**  
Monocomando doccia  
incasso due uscite **con  
deviatore a pulsante**  
*Two-way concealed  
shower single lever mixer  
with push diverter*  
• 0,1803

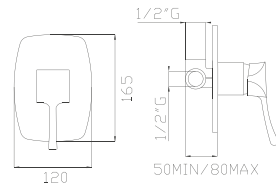

**42189**  
Monocomando doccia  
incasso  
*Concealed shower single  
lever mixer*  
• 0,1087

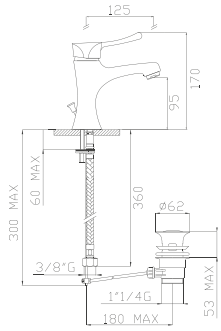

**42032**  
Monocomando lavabo  
con scarico  
*Basin single lever mixer  
with pop-up waste*  
• 0,1741

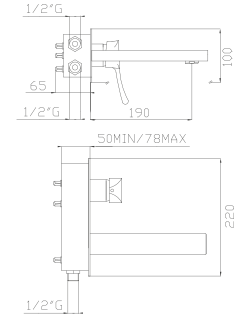

**42034**  
Monocomando lavabo  
ad incasso **completo di  
Easy-Box**  
*Concealed basin single  
lever mixer with  
Easy-Box*  
• 0,4797

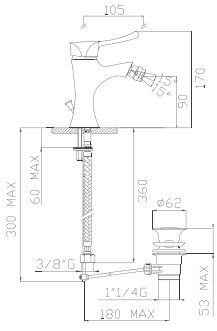

**42086**  
Monocomando bidet con  
scarico  
*Bidet single lever mixer  
with pop-up waste*  
• 0,1741

VASCA  
BATH

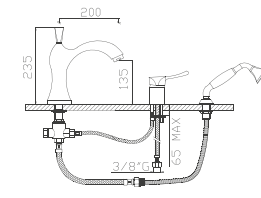

**42007**  
Monocomando bordo  
vasca tre fori  
*Three-hole deck mounted  
bath/shower single lever  
mixer*  
• 0,5336

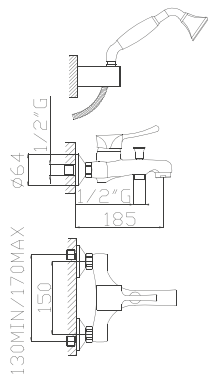

**42008**  
Monocomando vasca  
con doccia duplex e  
flessibile in ottone  
*Bath and shower single  
lever mixer with duplex  
and brass flexible hose*  
• 0,2677



**604**  
Bocca vasca a parete  
*Wall bath spout*  
• 0,2023

DOCCIA  
SHOWER

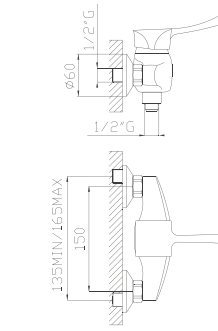

**42149**  
Monocomando doccia  
esterno  
*Wall mounted shower  
single lever mixer*  
• 0,1263

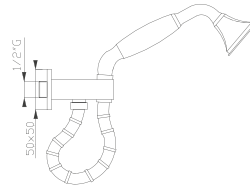

**186-10**  
Preso d'acqua con  
doccia e flessibile, in  
ottone  
*Brass wall outlet with  
handshower and flexible  
hose*  
• 0,1097

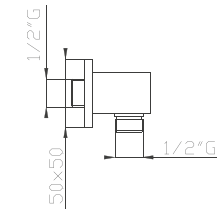

**184-03**  
Preso d'acqua in ottone  
*Brass water outlet*  
• 0,0296

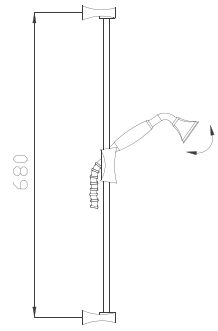

**231**  
Saliscendi con asta,  
flessibile e doccia in  
ottone  
*Brass sliding rail with  
flexible hose and brass  
handshower*  
• 0,1705



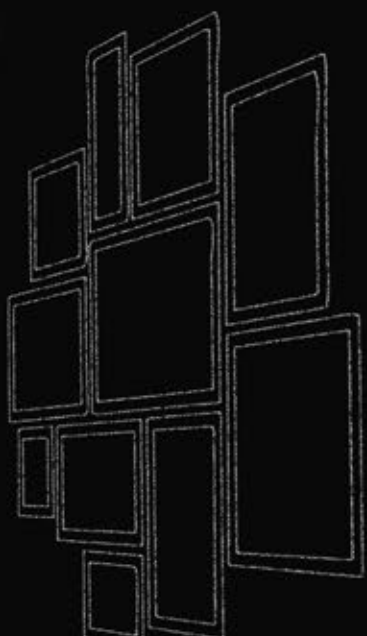
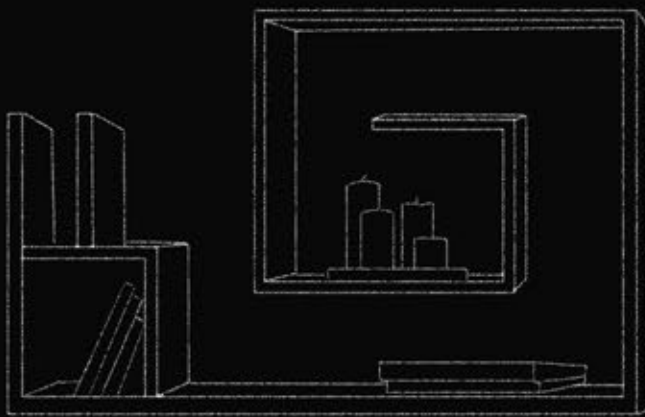

LAIRES

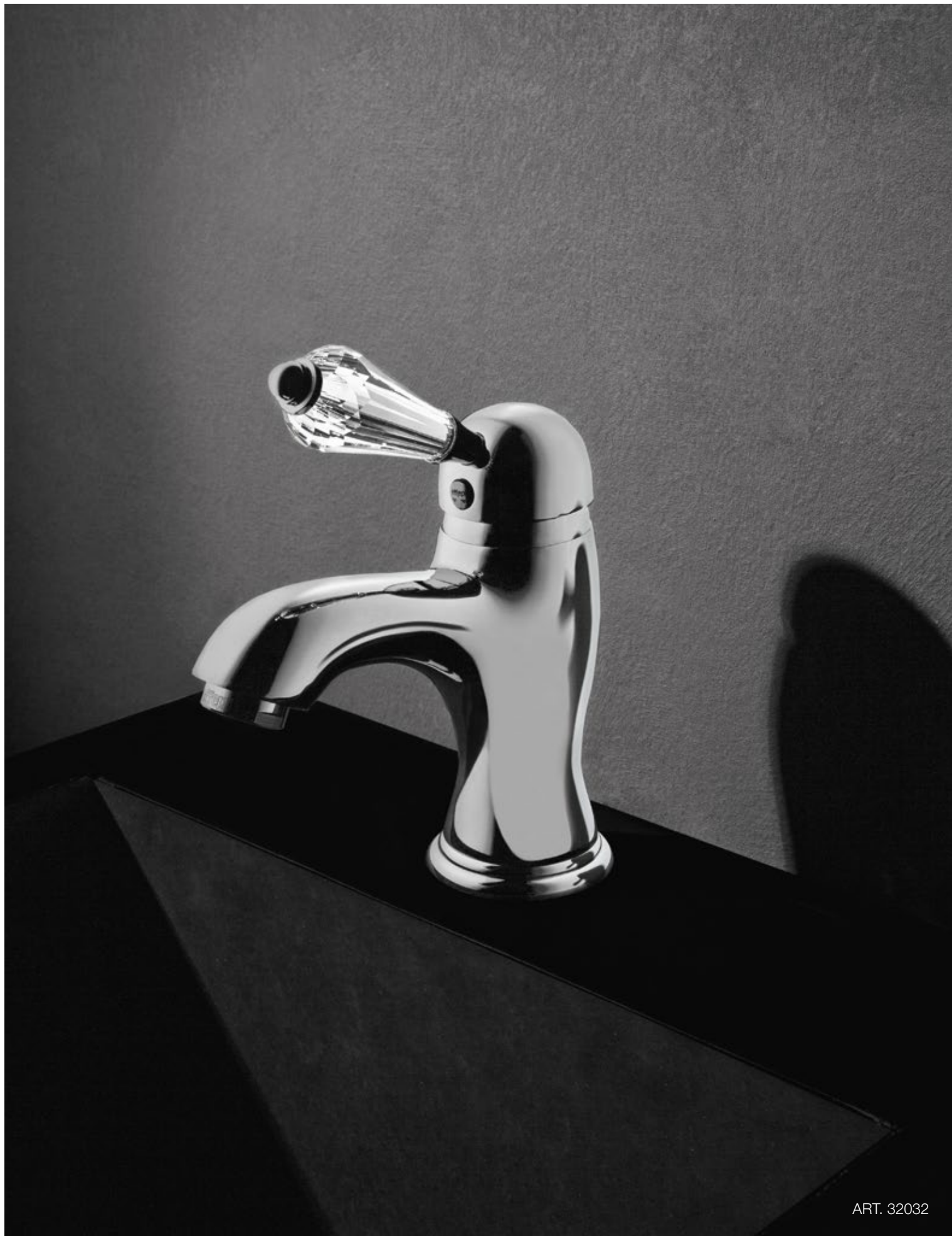

ART. 32032

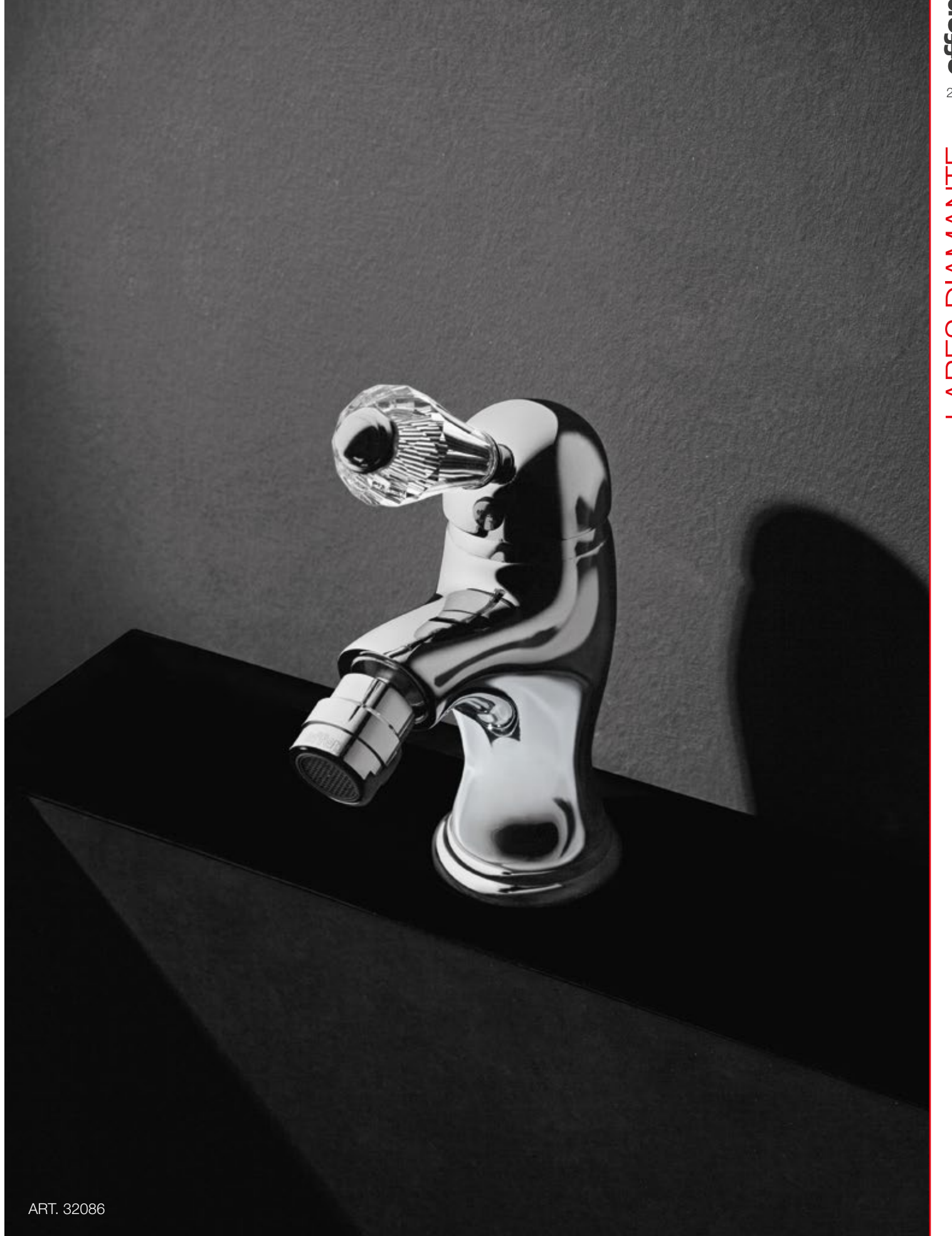

ART. 32086



ART. 31032



ART. 31008





ART. 31189



ART. 364 + ART. 372



ART. 29032



ART. 29086



DOCCIA  
SHOWER

ADATTABILE AL SISTEMA **UNI-BOX**  
PER DETTAGLI VEDERE LISTINO PREZZI  
SUITABLE FOR **UNI-BOX** SYSTEM  
FOR FURTHER DETAILS SEE THE PRICE LIST



LAVABO / BIDET  
WASHBASIN / BIDET

**32188**

Monocomando doccia  
incasso due uscite **con  
deviatore a pulsante  
con leva Swarovski**  
*Two-way concealed  
shower single lever mixer  
with push diverter with  
Swarovski lever*

- 0,2235

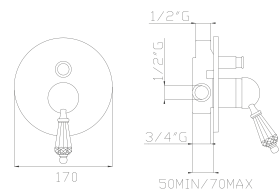

**32189**

Monocomando doccia  
incasso **con leva  
Swarovski**  
*Concealed shower  
single lever mixer with  
Swarovski lever*

- 0,1476

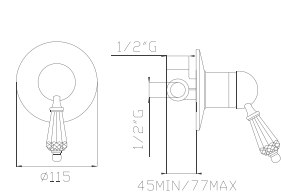

**32032**

Monocomando lavabo  
con scarico **con leva  
Swarovski**  
*Basin single lever mixer  
with pop-up waste with  
Swarovski lever*

- 0,2085

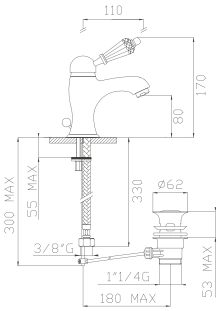

**32086**

Monocomando bidet  
con scarico **con leva  
Swarovski**  
*Bidet single lever mixer  
with pop-up waste with  
Swarovski lever*

- 0,2085

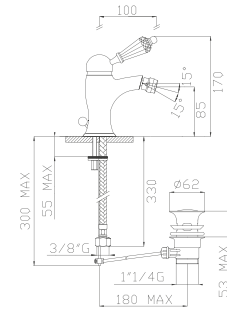

**186-09**

Presa d'acqua con  
doccia e flessibile, in  
ottone  
*Brass wall outlet with  
handshower and flexible  
hose*

- 0,0778



**184-01**

Presa d'acqua in ottone  
*Brass water outlet*

- 0,0128



VASCA  
BATH

**32008**

Monocomando vasca  
con duplex e flessibile  
in ottone **con leva  
Swarovski**  
*Bath and shower single  
lever mixer with brass  
duplex and flexible hose  
with Swarovski lever*

- 0,3022

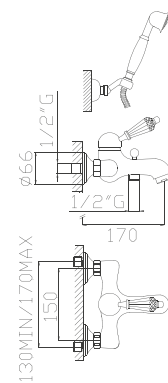

DOCCIA  
SHOWER

**241**

Saliscendi con asta  
flessibile e doccia in  
ottone  
*Brass sliding rail with  
flexible hose and  
handshower*

- 0,2085

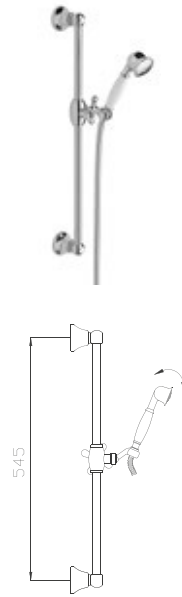

**372**

Braccio doccia in ottone  
*Brass wall shower arm*

- 0,0389

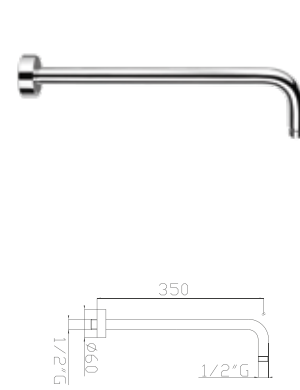

**603**

Bocca vasca a parete  
*Wall bath spout*

- 0,0998



**364**

Soffione doccia in ottone  
con anticalcare  
*Brass shower head with  
antiscale*

- 0,1678

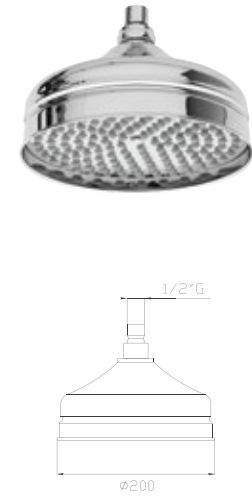



DOCCIA  
SHOWER

ADATTABILE AL SISTEMA **UNI-BOX**  
PER DETTAGLI VEDERE LISTINO PREZZI  
SUITABLE FOR **UNI-BOX** SYSTEM  
FOR FURTHER DETAILS SEE THE PRICE LIST



**31188**

Monocomando doccia  
incasso due uscite **con  
deviatore a pulsante**  
*Two-way concealed  
shower single lever mixer  
with push diverter*  
• 0,1785



**31189**

Monocomando doccia  
incasso  
*Concealed shower single  
lever mixer*  
• 0,1034



**186-09**

Preso d'acqua con  
doccia e flessibile, in  
ottone  
*Brass wall outlet with  
handshower and flexible  
hose*  
• 0,0778



**184-01**

Preso d'acqua in ottone  
*Brass water outlet*  
• 0,0128

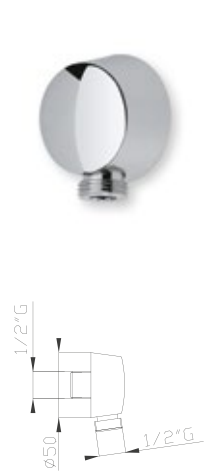

VASCA  
BATH

**31008**

Monocomando vasca  
con duplex e flessibile in  
ottone  
*Bath and shower single  
lever mixer with brass  
duplex and flexible hose*  
• 0,2483

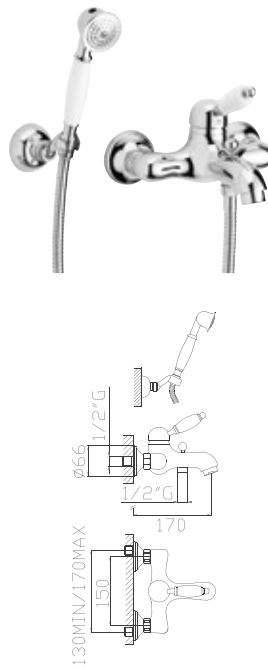

**603**

Bocca vasca a parete  
*Wall bath spout*  
• 0,0998



DOCCIA  
SHOWER

**241**

Saliscendi con asta  
flessibile e doccia in  
ottone  
*Brass sliding rail with  
flexible hose and  
handshower*  
• 0,2085

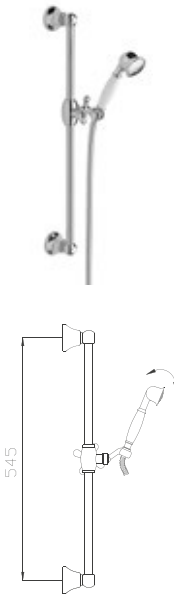

**372**

Braccio doccia in ottone  
*Brass wall shower arm*  
• 0,0389



**364**

Soffione doccia in ottone  
con anticalcare  
*Brass shower head with  
antiscale*  
• 0,1678

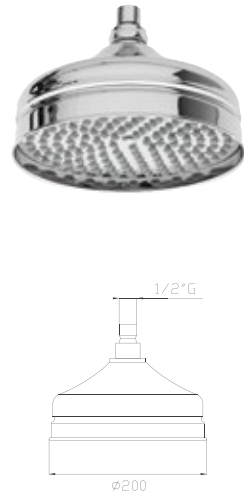

LAVABO / BIDET  
WASHBASIN / BIDET

**31032**

Monocomando lavabo  
con scarico  
*Basin single lever mixer  
with pop-up waste*  
• 0,1634

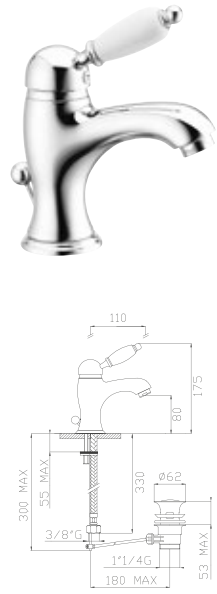

**31086**

Monocomando bidet con  
scarico  
*Bidet single lever mixer  
with pop-up waste*  
• 0,1634

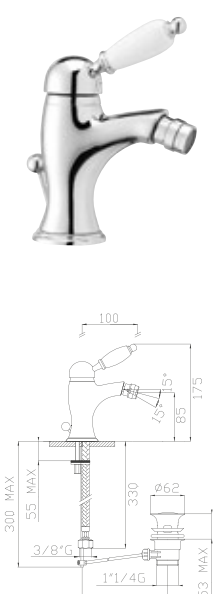



DOCCIA  
SHOWER

ADATTABILE AL SISTEMA **UNI-BOX**  
PER DETTAGLI VEDERE LISTINO PREZZI  
SUITABLE FOR **UNI-BOX** SYSTEM  
FOR FURTHER DETAILS SEE THE PRICE LIST

LAVABO / BIDET  
WASHBASIN / BIDET

**29187**

Monocomando doccia  
incasso tre uscite  
*Three-way concealed  
shower single lever mixer*  
• 0,2279



**29032**

Monocomando lavabo  
con scarico  
*Basin single lever mixer  
with pop-up waste*  
• 0,1458

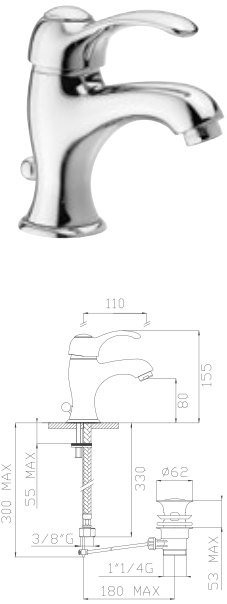

**29188**

Monocomando doccia  
incasso due uscite **con  
deviatore a pulsante**  
*Two-way concealed  
shower single lever mixer  
with push diverter*  
• 0,1573



**29086**

Monocomando bidet con  
scarico  
*Bidet single lever mixer  
with pop-up waste*  
• 0,1458

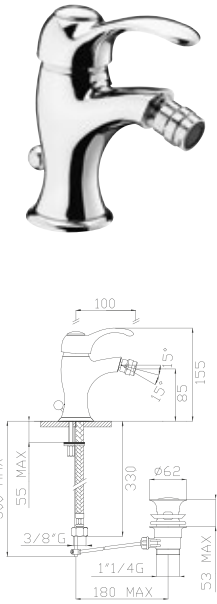

**29189**

Monocomando doccia  
incasso  
*Concealed shower single  
lever mixer*  
• 0,0910



DOCCIA  
SHOWER

**372**

Braccio doccia in ottone  
*Brass wall shower arm*  
• 0,0389

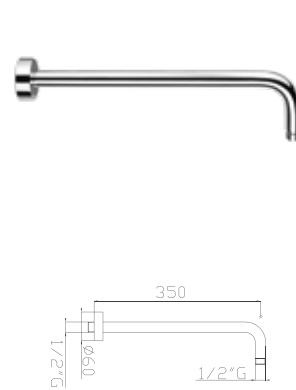

**29149**

Monocomando doccia  
esterno  
*Wall mounted shower  
single lever mixer*  
• 0,1052

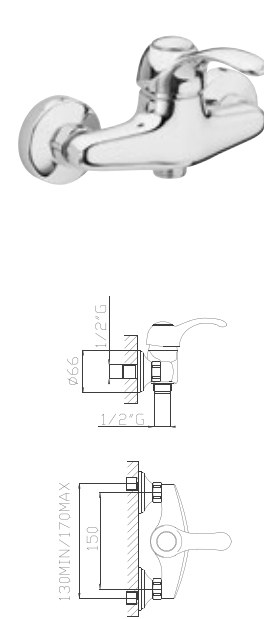

**364**

Soffione doccia in ottone  
con anticalcare  
*Brass shower head with  
antiscala*  
• 0,1678

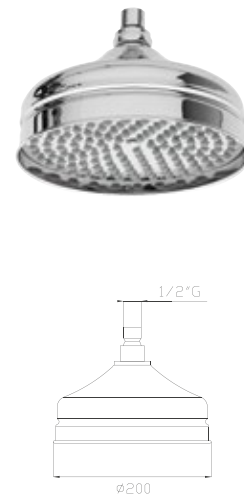

**186-09**

Preso d'acqua con  
doccia e flessibile, in  
ottone  
*Brass wall outlet with  
handshower and flexible  
hose*  
• 0,0778



**184-01**

Preso d'acqua in ottone  
*Brass water outlet*  
• 0,0128



**241**

Saliscendi con asta  
flessibile e doccia in  
ottone  
*Brass sliding rail with  
flexible hose and  
handshower*  
• 0,2085

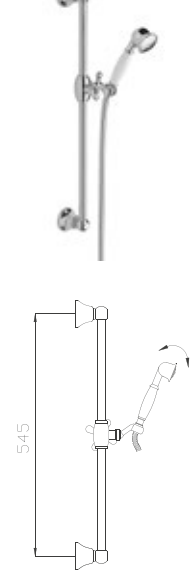



VASCA  
BATH

**29008**

Monocomando vasca  
con duplex e flessibile in  
ottone

*Bath and shower single  
lever mixer with brass  
duplex and flexible hose*

- 0,2200

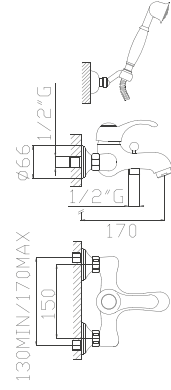

**603**

Bocca vasca a parete  
*Wall bath spout*

- 0,0998

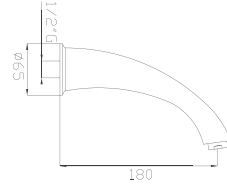

“

**TERMOMIX**

”





DOCCIA  
SHOWER

**18387**

Miscelatore termostatico doccia incasso tre uscite  
*Three-way concealed shower thermostatic mixer*  
• 0,7994

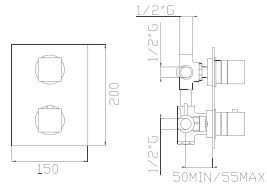

**18388**

Miscelatore termostatico doccia incasso due uscite  
*Two-way concealed shower thermostatic mixer*  
• 0,7773

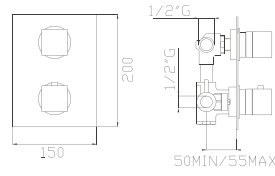

**18389**

Miscelatore termostatico doccia incasso  
*Concealed shower thermostatic mixer*  
• 0,7041

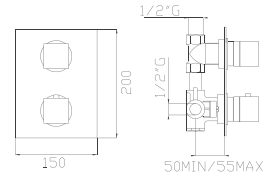

**18344**

Miscelatore termostatico doccia esterno  
*Thermostatic external shower mixer*  
• 0,6113

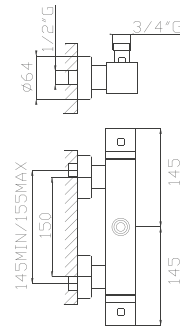

**18287**

Miscelatore termostatico doccia incasso tre uscite  
*Three-way concealed shower thermostatic mixer*  
• 0,5786

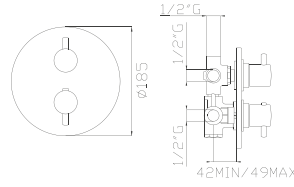

**18288**

Miscelatore termostatico doccia incasso due uscite  
*Two-way concealed shower thermostatic mixer*  
• 0,5565

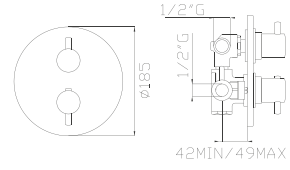

**18289**

Miscelatore termostatico doccia incasso  
*Concealed shower thermostatic mixer*  
• 0,4788

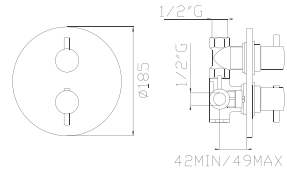

**18249**

Miscelatore termostatico doccia esterno  
*Thermostatic external shower mixer*  
• 0,3596

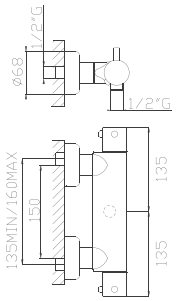

**18349**

Miscelatore termostatico doccia esterno  
*Thermostatic external shower mixer*  
• 0,5689

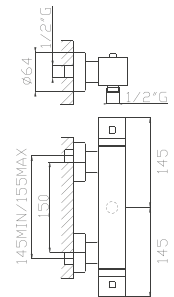

**18347**

Miscelatore termostatico doccia esterno con colonna, deviatore, flessibile Cromotech, soffione e doccia in ottone  
*Thermostatic external shower mixer with column, diverter, Cromotech flexible hose, brass showerhead and brass handshower*  
• 1,1784

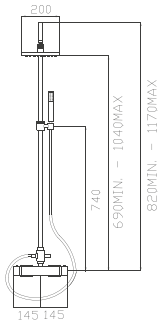

**18247**

Miscelatore termostatico doccia esterno con colonna, deviatore, flessibile Cromotech, soffione e doccia in ottone  
*Thermostatic external shower mixer with column, diverter, Cromotech flexible hose, brass showerhead and brass handshower*  
• 0,9823

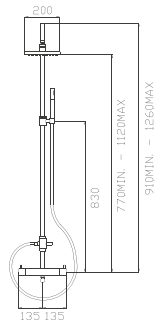

DOCCIA  
SHOWER

DOCCIA  
SHOWER

18187

Miscelatore termostatico doccia incasso tre uscite  
*Three-way concealed shower thermostatic mixer*  
• 0,3189

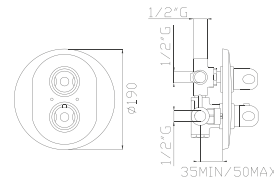

18188

Miscelatore termostatico doccia incasso due uscite  
*Two-way concealed shower thermostatic mixer*  
• 0,3074

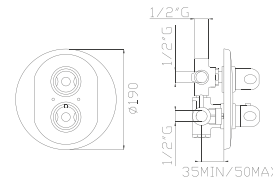

18189

Miscelatore termostatico doccia incasso  
*Concealed shower thermostatic mixer*  
• 0,2668

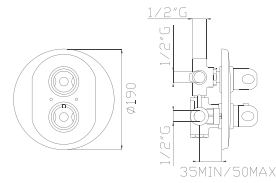

18144

Miscelatore termostatico doccia esterno  
*Thermostatic external shower mixer*  
• 0,1546

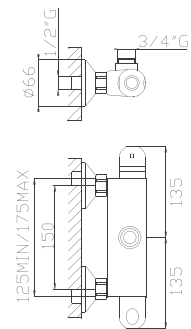

ADATTABILE AL SISTEMA UNI-BOX  
PER DETTAGLI VEDERE LISTINO PREZZI  
SUITABLE FOR UNI-BOX SYSTEM  
FOR FURTHER DETAILS SEE THE PRICE-LIST

DOCCIA  
SHOWER

17187

Monocomando termostatico doccia incasso tre uscite  
*Three-way concealed shower thermostatic single lever mixer*  
• 0,3304

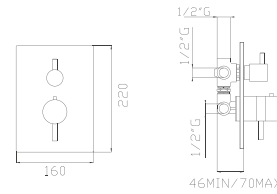
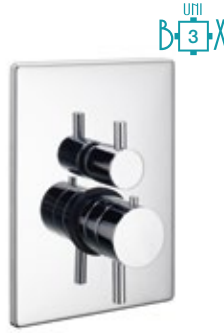

17188

Monocomando termostatico doccia incasso due uscite con deviatore a pulsante  
*Two-way concealed shower thermostatic single lever mixer with push diverter*  
• 0,2933

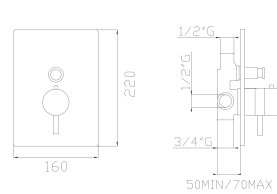

17189

Monocomando termostatico doccia incasso  
*Concealed shower thermostatic single lever mixer*  
• 0,2456

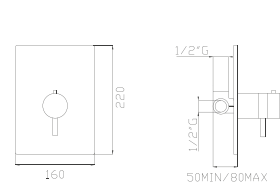
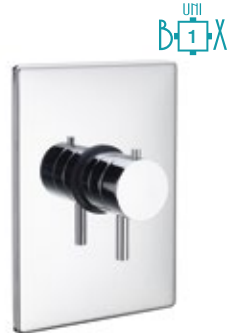

18149

Miscelatore termostatico doccia esterno  
*Thermostatic external shower mixer*  
• 0,1317

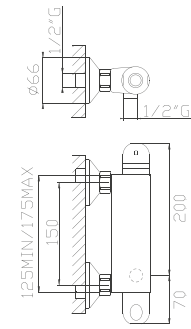

18147

Miscelatore termostatico doccia esterno con colonna, deviatore, flessibile, soffione e doccia in ottone  
*Thermostatic external shower mixer with column, diverter, brass flexible hose, brass showerhead and brass handshower*  
• 0,6423

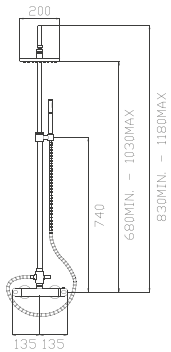

17186

Monocomando termostatico doccia incasso 4 uscite **non adattabile al sistema Uni-Box**  
*Four-way concealed shower thermostatic single lever mixer not suitable for Uni-Box system*  
• 0,3304

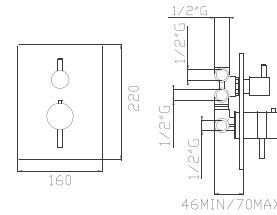

“

# AMBIENTE DOCCIA

”



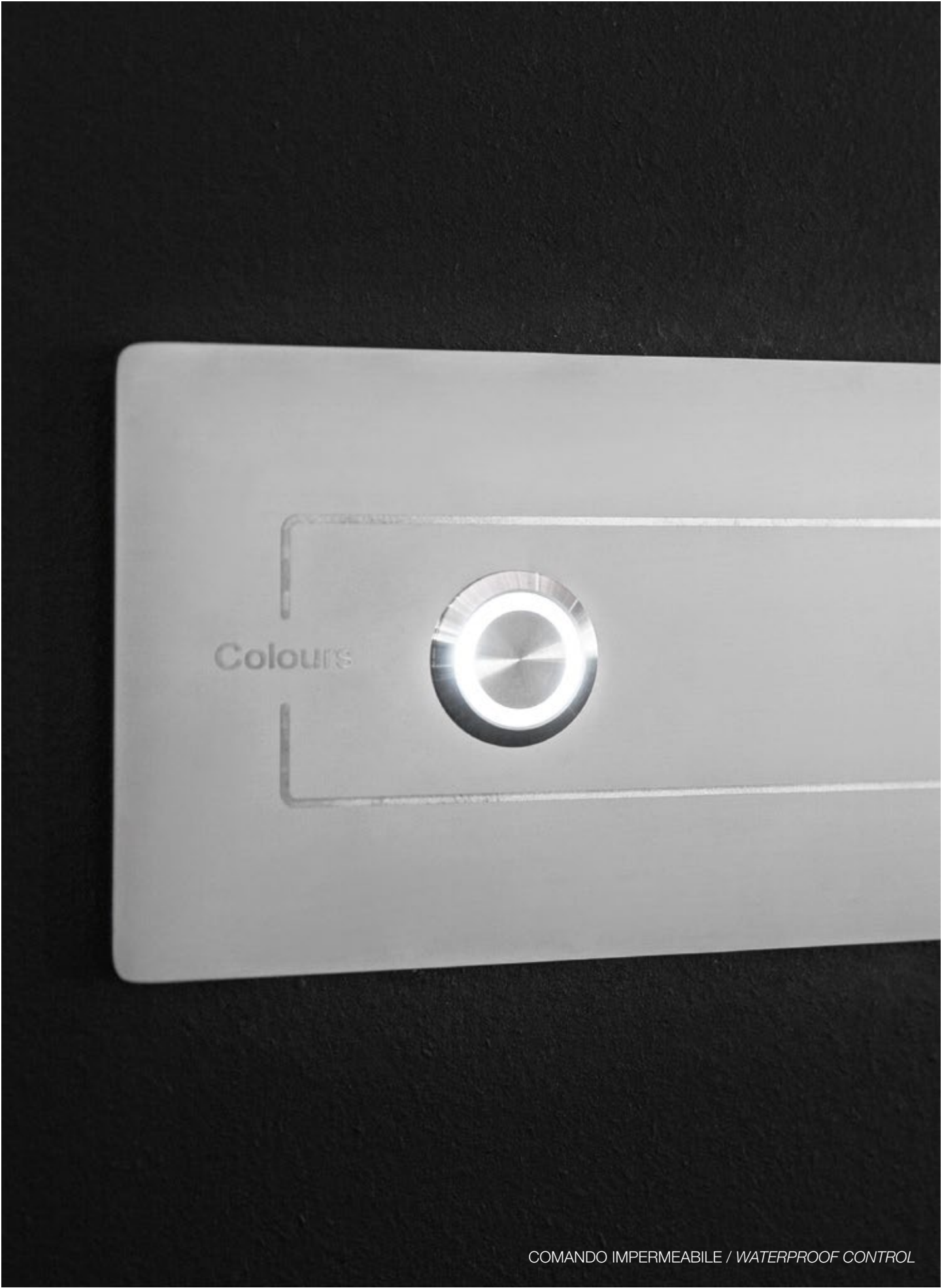

COMANDO IMPERMEABILE / WATERPROOF CONTROL

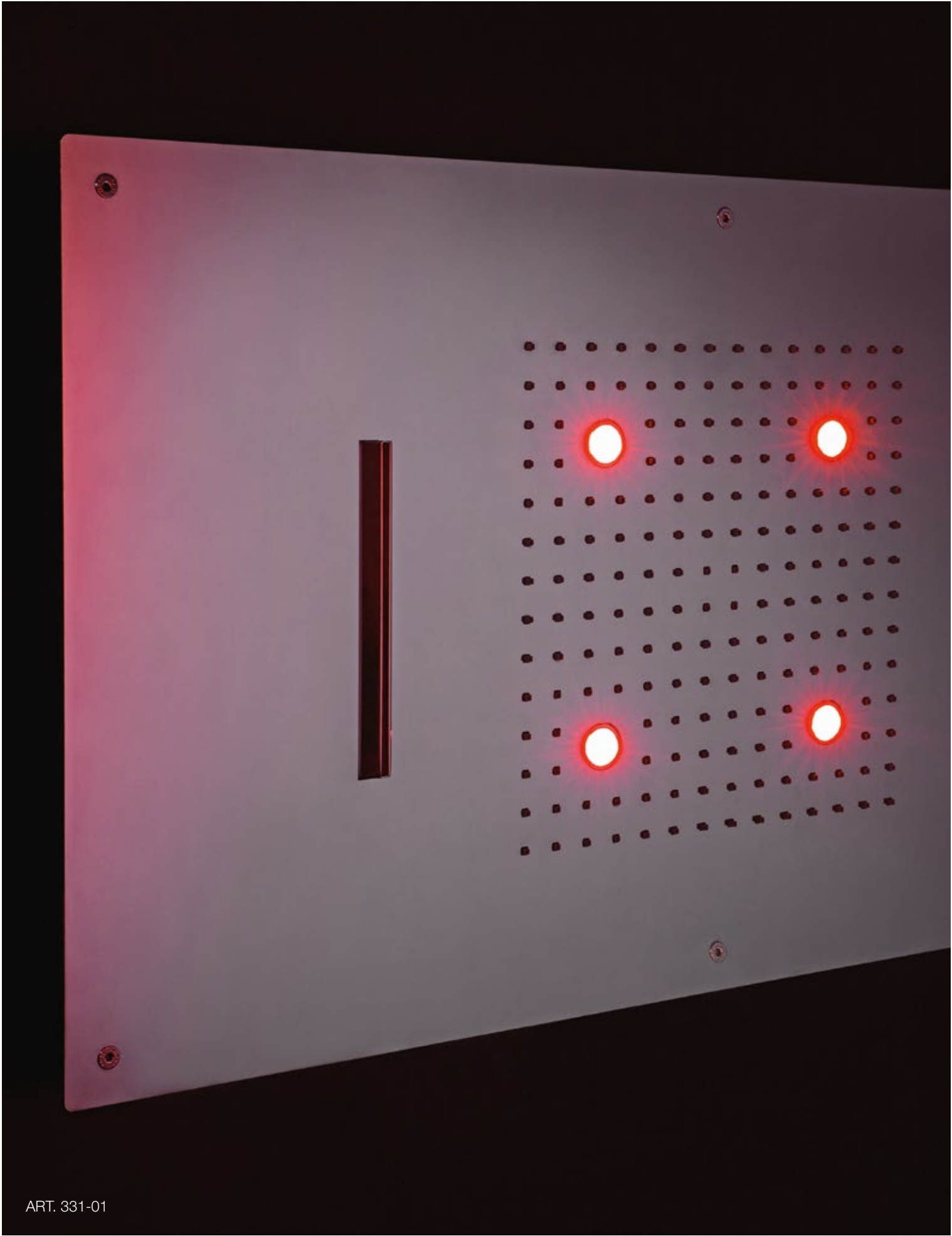

ART. 331-01

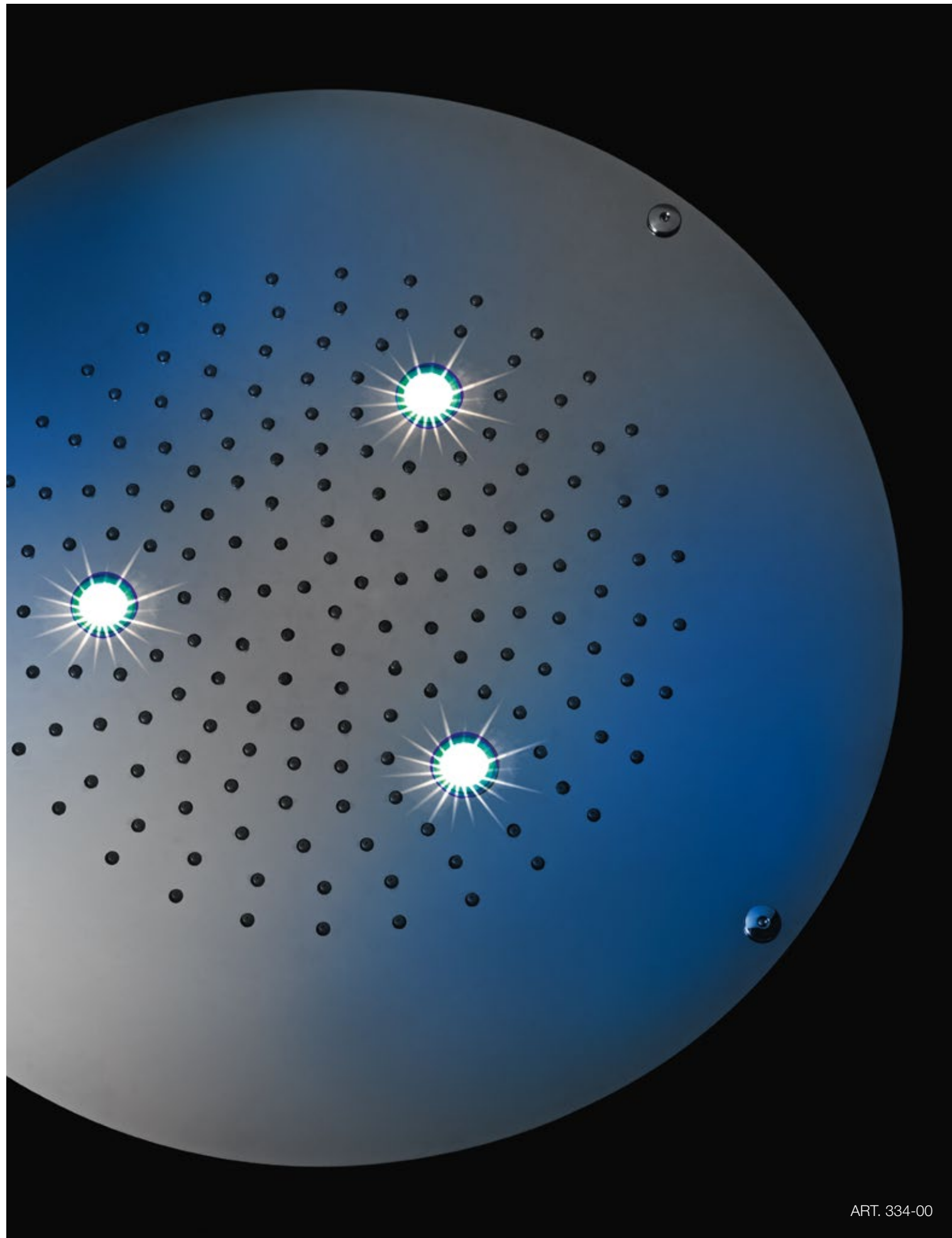

ART. 334-00

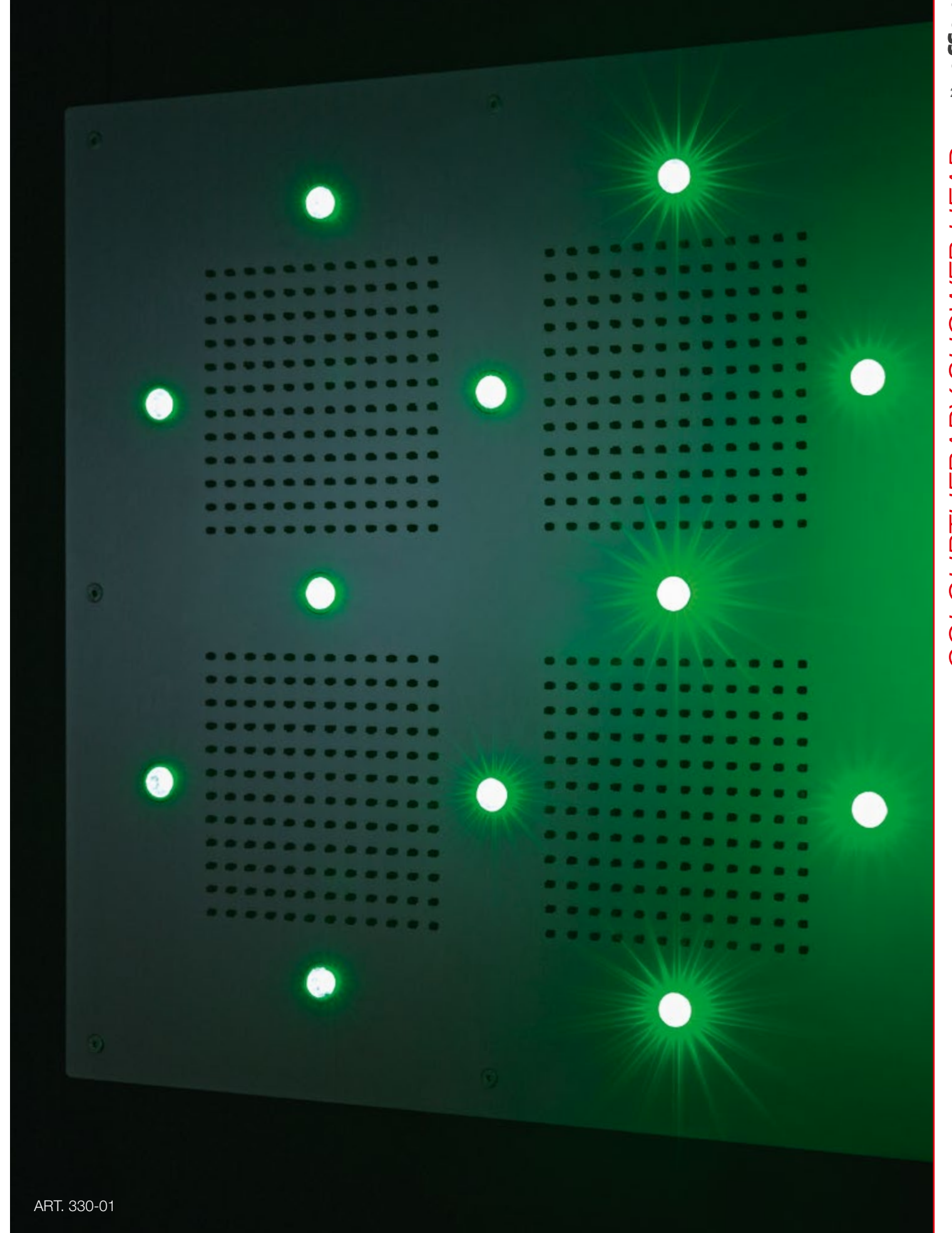

ART. 330-01



DOCCIA  
SHOWER

CASCATA  
CASCADE

NEBULIZZATO  
MIST

PIOGGIA  
RAIN

**330-00**

Soffione doccia inox cromoterapia a soffitto 540x540

*Inox ceiling shower head with chromotherapy*  
• 3,4185

2 GETTI  
JETS

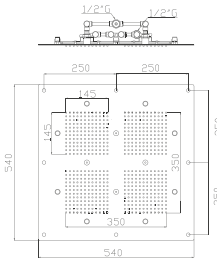

**330-01**

Soffione doccia inox cromoterapia a soffitto 540x540

*Inox ceiling shower head with chromotherapy*  
• 3,0767

1 GETTO  
JET

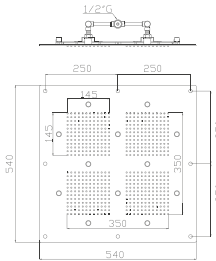

**330-02**

Soffione doccia inox a soffitto 488x488

*Inox ceiling shower head*  
• 1,0256

1 GETTO  
JET

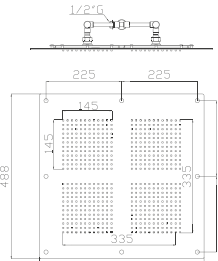

**331-00**

Soffione doccia inox cromoterapia a soffitto 700x400

*Inox ceiling shower head with chromotherapy*  
• 3,2481

3 GETTI  
JETS

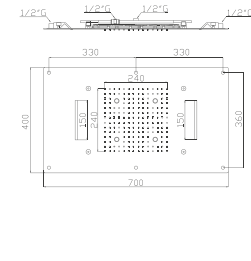

**331-01**

Soffione doccia inox cromoterapia a soffitto 700x400

*Inox ceiling shower head with chromotherapy*  
• 2,9062

2 GETTI  
JETS

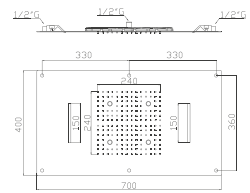

**331-02**

Soffione doccia inox a soffitto 700x400

*Inox ceiling shower head*  
• 1,3507

2 GETTI  
JETS

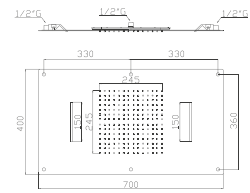

**331-03**

Soffione doccia inox a soffitto 700x400

*Inox ceiling shower head*  
• 0,8896

1 GETTO  
JET

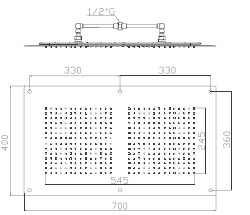

**332-00**

Soffione doccia inox cromoterapia a soffitto 550x400

*Inox ceiling shower head with chromotherapy*  
• 2,9062

3 GETTI  
JETS

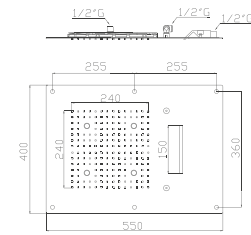

**332-01**

Soffione doccia inox cromoterapia a soffitto 550x400

*Inox ceiling shower head with chromotherapy*  
• 2,5653

2 GETTI  
JETS

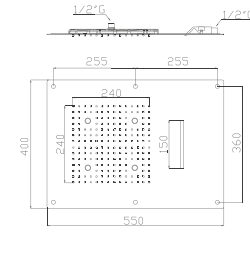

**332-02**

Soffione doccia inox a soffitto 550x400

*Inox ceiling shower head*  
• 1,0088

2 GETTI  
JETS

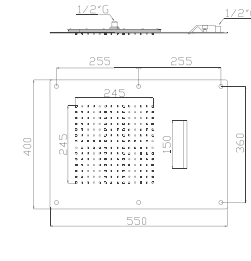

**333-00**

Soffione doccia inox cromoterapia a soffitto 400x400

*Inox ceiling shower head with chromotherapy*  
• 2,0520

1 GETTO  
JET

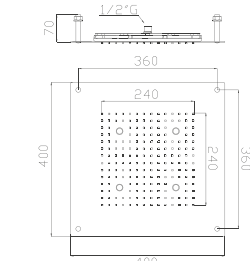

**333-01**

Soffione doccia inox a soffitto 400x400

*Inox ceiling shower head*  
• 0,6846

1 GETTO  
JET

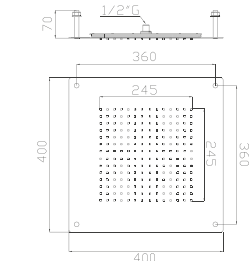

**333-02**

Soffione doccia inox a soffitto 280x280

*Inox ceiling shower head*  
• 0,5142

1 GETTO  
JET

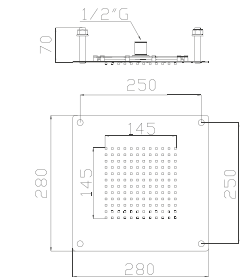

**334-00**

Soffione doccia inox cromoterapia a soffitto Ø 400

*Inox ceiling shower head with chromotherapy*  
• 1,9143

1 GETTO  
JET

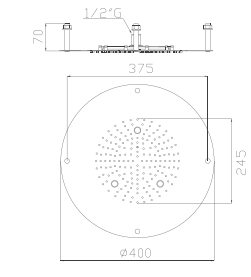

**334-01**

Soffione doccia inox a soffitto Ø 400

*Inox ceiling shower head*  
• 0,6493

1 GETTO  
JET

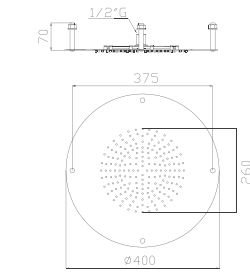

**334-02**

Soffione doccia inox a soffitto Ø 300

*Inox ceiling shower head*  
• 0,4620

1 GETTO  
JET

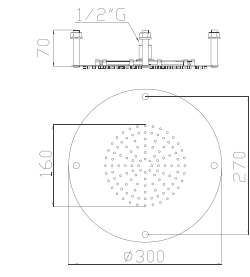



DOCCIA  
SHOWER

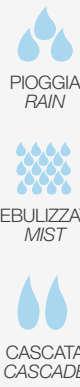

**335-01**

Soffione doccia inox a parete  
*Inox wall shower head*  
• 0,6183

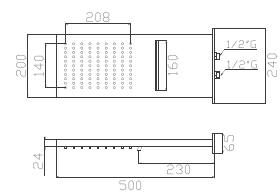

**336-01**

Soffione doccia inox a parete  
*Inox wall shower head*  
• 0,6767

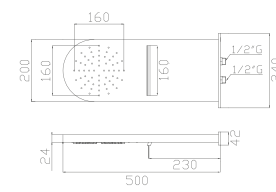

**369**

Soffione doccia in ABS anticalcare Ø 200  
*ABS shower head with antiscala*  
• 0,0720

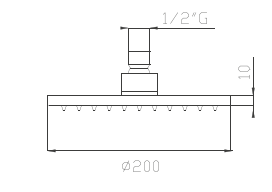

**364**

Soffione doccia in ottone con anticalcare Ø 200  
*Brass shower head with antiscala*  
• 0,1678

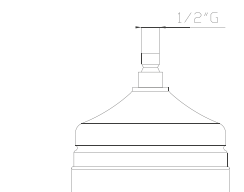

**367-30\***

Soffione doccia in ottone con anticalcare 300x300  
*Brass shower head with antiscala*  
• 0,2986

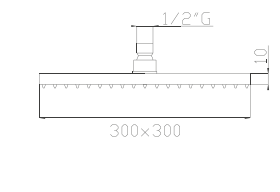
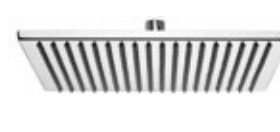

**367-40\***

Soffione doccia in ottone con anticalcare 400x400  
*Brass shower head with antiscala*  
• 0,4470

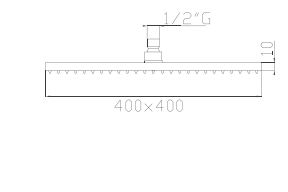

**359**

Soffione laterale esterno orientabile, in ottone  
*Brass external adjustable body jet*  
• 0,0308

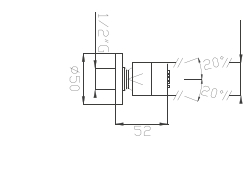
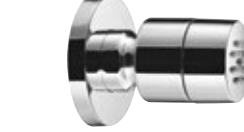

**360**

Soffione laterale esterno orientabile, in ottone  
*Brass external adjustable body jet*  
• 0,0445

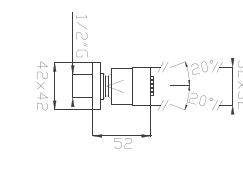

**366**

Soffione doccia in ottone con anticalcare Ø 200  
*Brass shower head with antiscala*  
• 0,1175

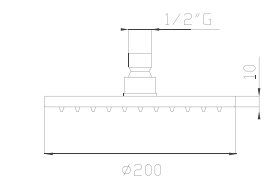

**366-30\***

Soffione doccia in ottone con anticalcare Ø 300  
*Brass shower head with antiscala*  
• 0,2642

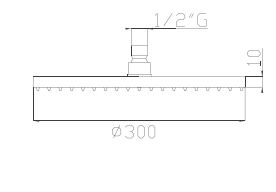
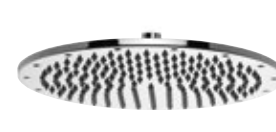

**366-40\***

Soffione doccia in ottone con anticalcare Ø 400  
*Brass shower head with antiscala*  
• 0,3967

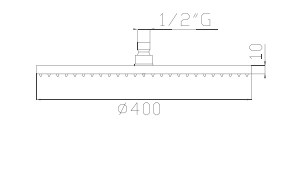
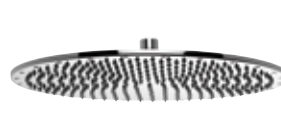

**367**

Soffione doccia in ottone con anticalcare 200x200  
*Brass shower head with antiscala*  
• 0,1546

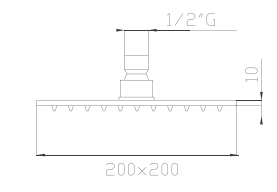

**362**

Soffione laterale a parete orientabile in ABS  
*ABS wall adjustable body jet*  
• 0,0808

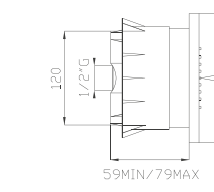

**363**

Soffione laterale a parete orientabile in ABS  
*ABS wall adjustable body jet*  
• 0,0852

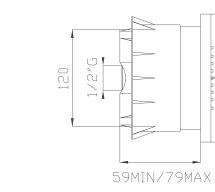

\* Per l'installazione utilizzare il nostro braccio doccia rinforzato ART. 372RI  
To install use our reinforced shower arm ART. 372RI

\* Per l'installazione utilizzare il nostro braccio doccia rinforzato ART. 376RI  
To install use our reinforced shower arm ART. 376RI





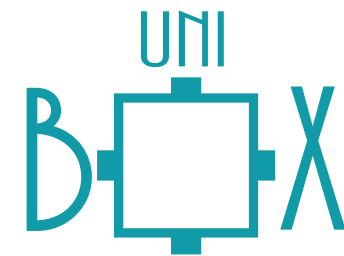
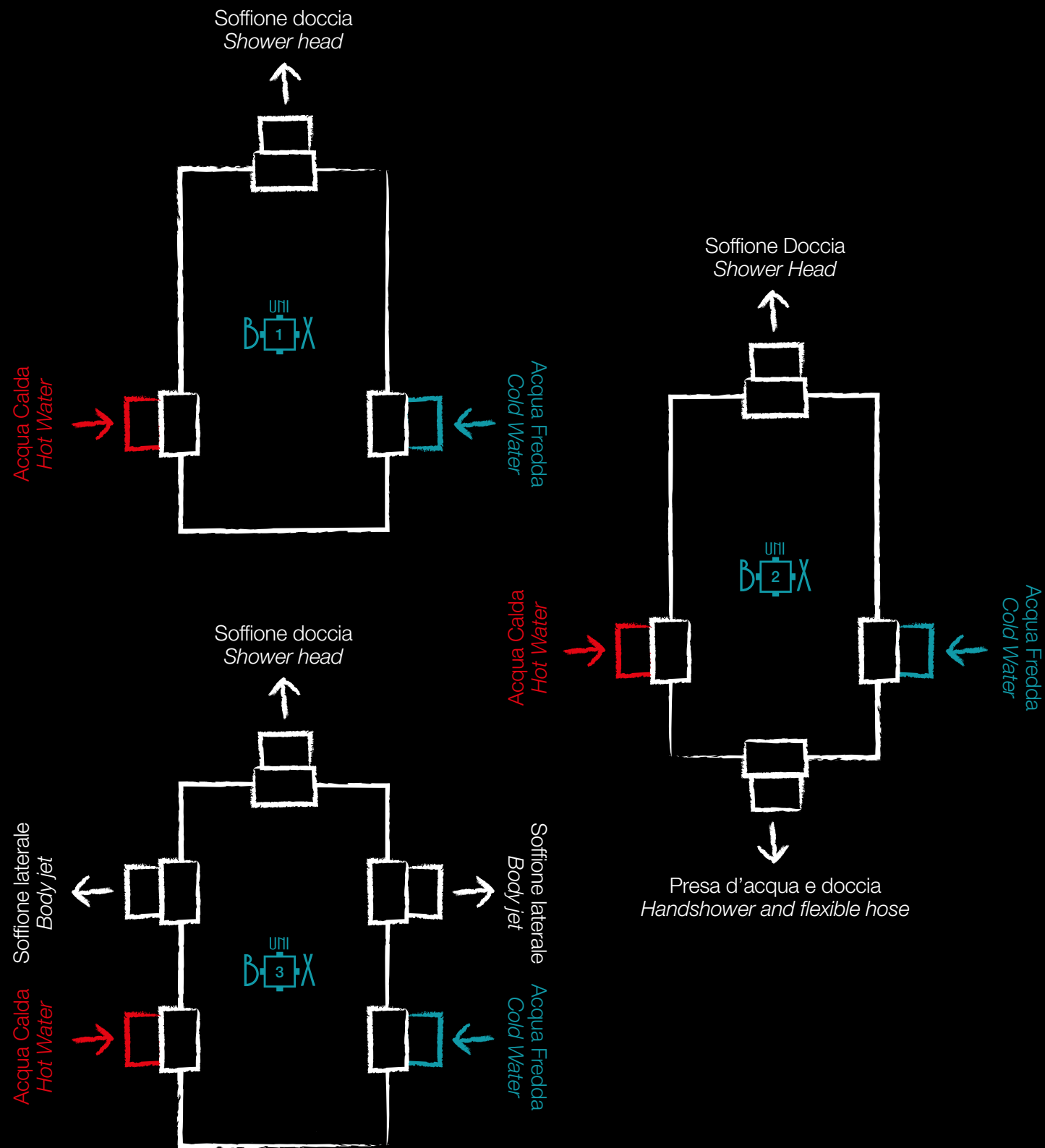

## EFFEPI REINVENTA L'INSTALLAZIONE DEI MONOCOMANDO DA INCASSO

## EFFEPI REINVENTS THE INSTALLATION OF CONCEALED SINGLE-LEVER SHOWER MIXERS

### Installazione senza pensieri

Grazie ad Uni-box, scatola realizzata in acciaio zincato ideata per proteggere il meccanismo interno dei monocomando da incasso tradizionali o Uni-Termo ad una, due uscite e tre uscite sarà possibile predisporre l'impianto doccia installando la sola scatola senza necessità di scegliere la rubinetteria in anticipo con la struttura ancora al grezzo.

### Scegli il tuo stile

Terminati tutti i lavori di rifinitura è giunto il momento di rendere esclusivo l'ambiente doccia. Innumerevoli varianti di stile potranno essere combinate all'arredo della sala da bagno.

### Sicurezza

La funzionalità progettuale di Uni-box permette di ispezionare, smontare e rimontare in qualsiasi momento il monocomando alloggiato all'interno della parete.

### Demolizioni addio!

Qualora fosse necessario sostituire il monocomando, l'intervento risulterà essere facile e immediato anche dopo anni dall'installazione. Il tutto senza interventi di demolizione e opere murarie.

Il prodotto Uni-box è coperto da brevetto numero MI2012A001488  
Modello depositato-Patented



### Trouble-free installation

Thanks to Uni-box, a box made in galvanised steel designed to protect the inner mechanisms of traditional or Uni-Termo one/two/three-way concealed single-lever mixers, the shower system can be set up by installing the box on its own without the need to choose the taps beforehand while the structure is still unfinished.

### Choose your style

Once all the work has finished, it is time to make the shower room exclusive. Endless different styles can be combined with the bathroom fittings.

### Safety

The design functionality of Uni-box makes it possible to inspect, dismantle and re-assemble the single-lever mixer housed inside the wall.

### Goodbye demolition work!

If you have to replace the single-lever mixer, it will be easy and immediate to do even several years after it has been installed. Demolition and masonry work won't be necessary.

The Uni-box is covered by patent number MI2012A001488  
Filed-patented model



Matera  
Cucina  
...  
...  
...  
...  
...  
...  
...

Globe

Kalena

CUCINA



ART. 30188



ART. 30189



ART. 30187

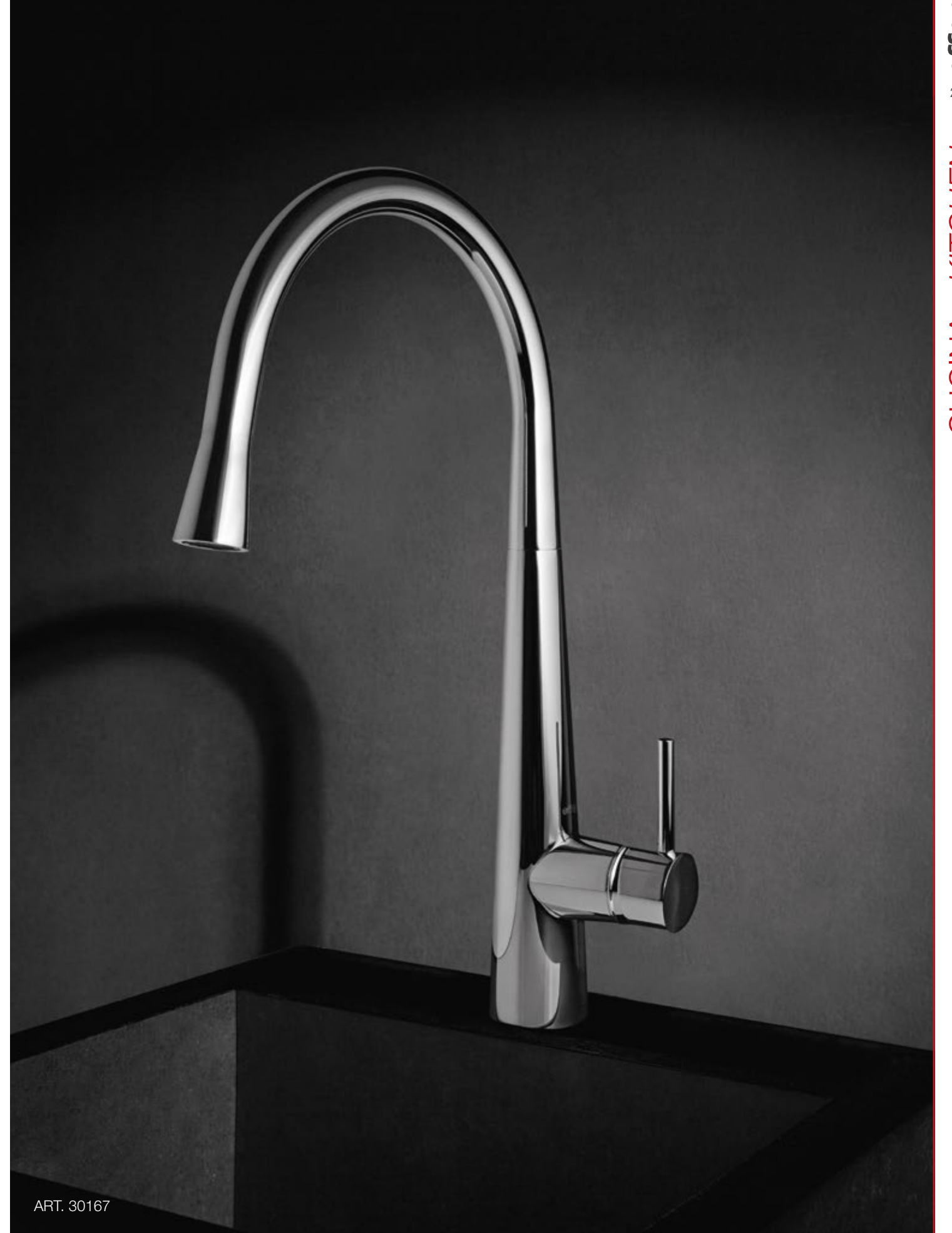

ART. 30167



ART. 30168



ART. 30160



ART. 30159

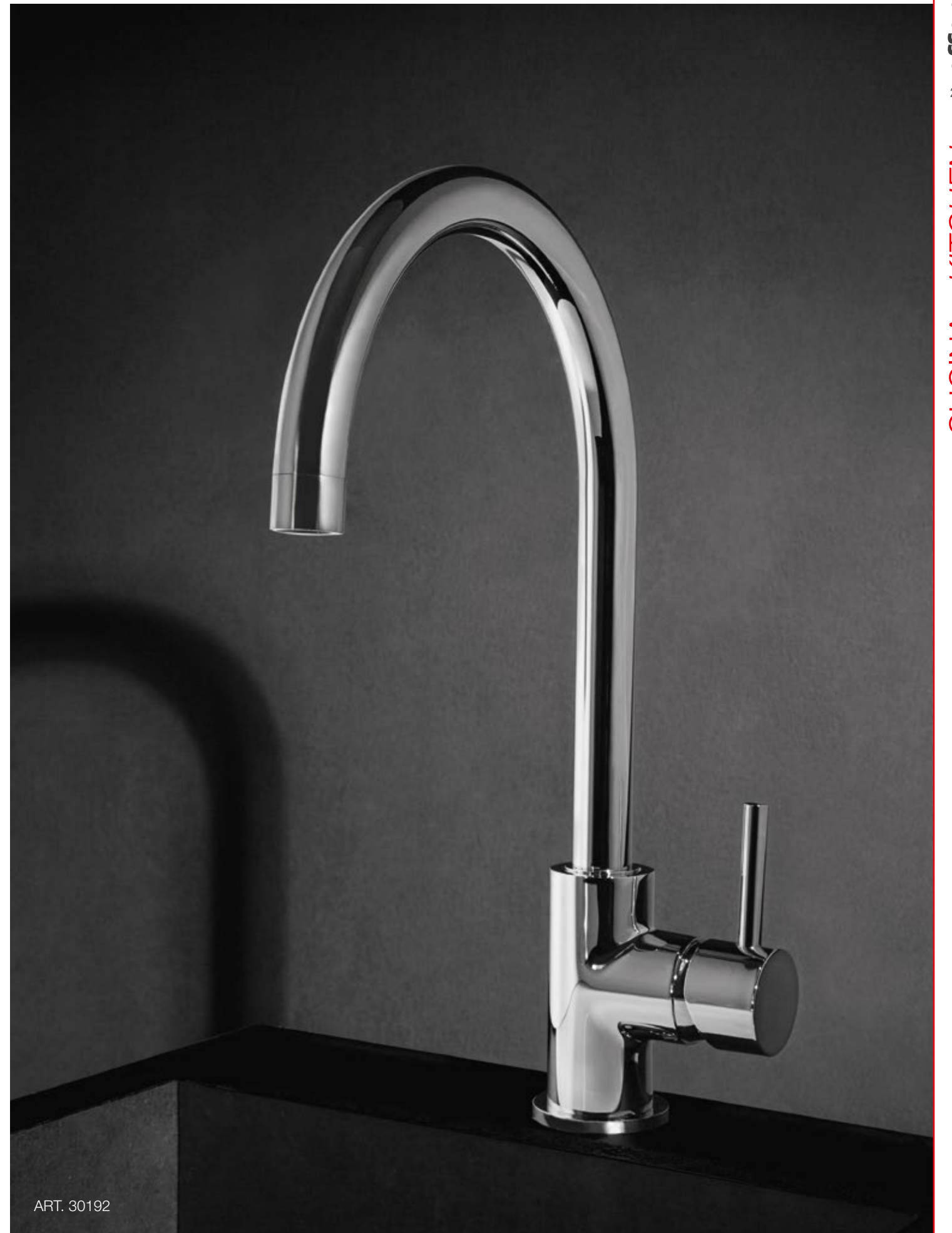

ART. 30192



ART. 14191



ART. 15170



ART. 30181

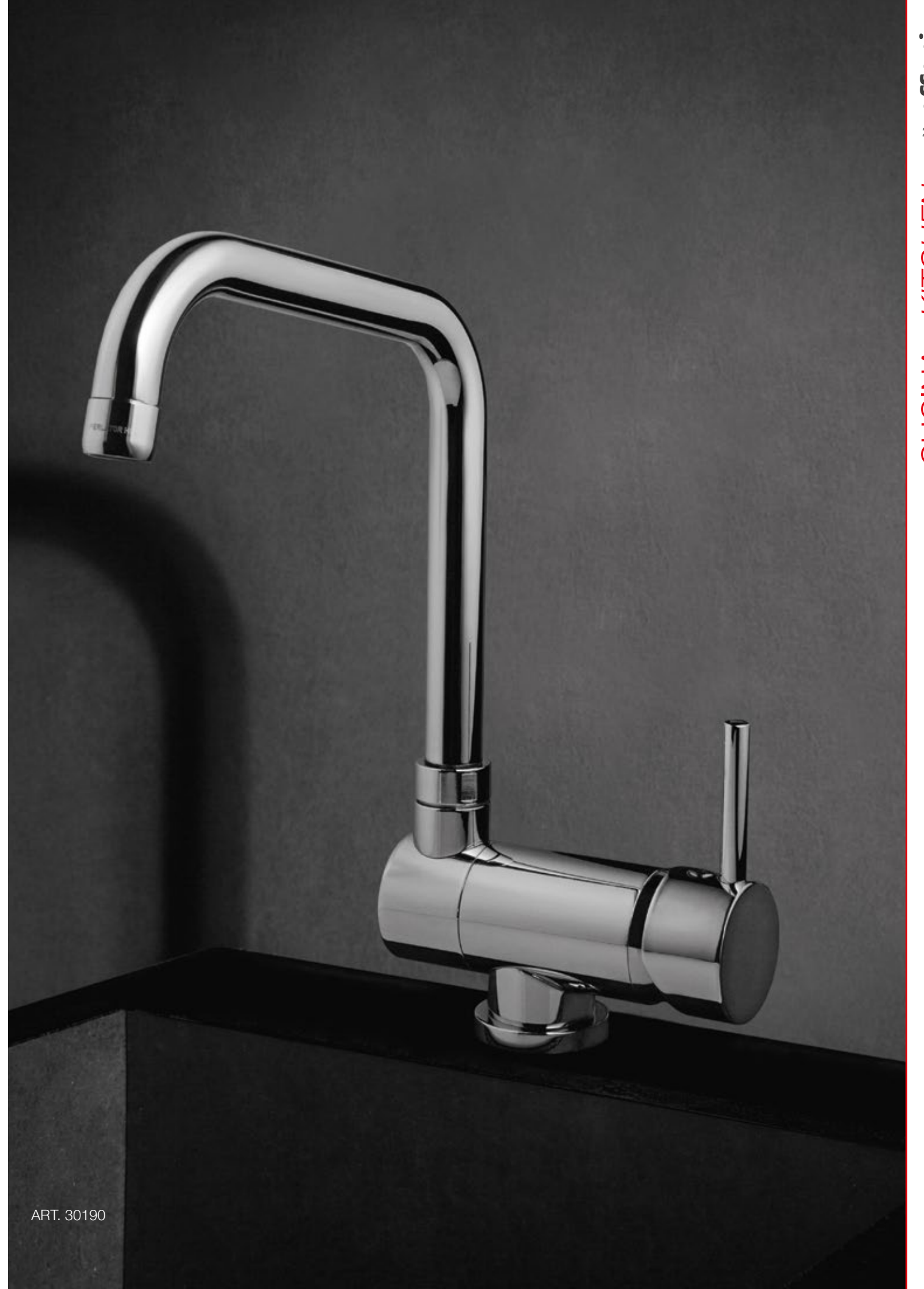

ART. 30190





ART. 30180

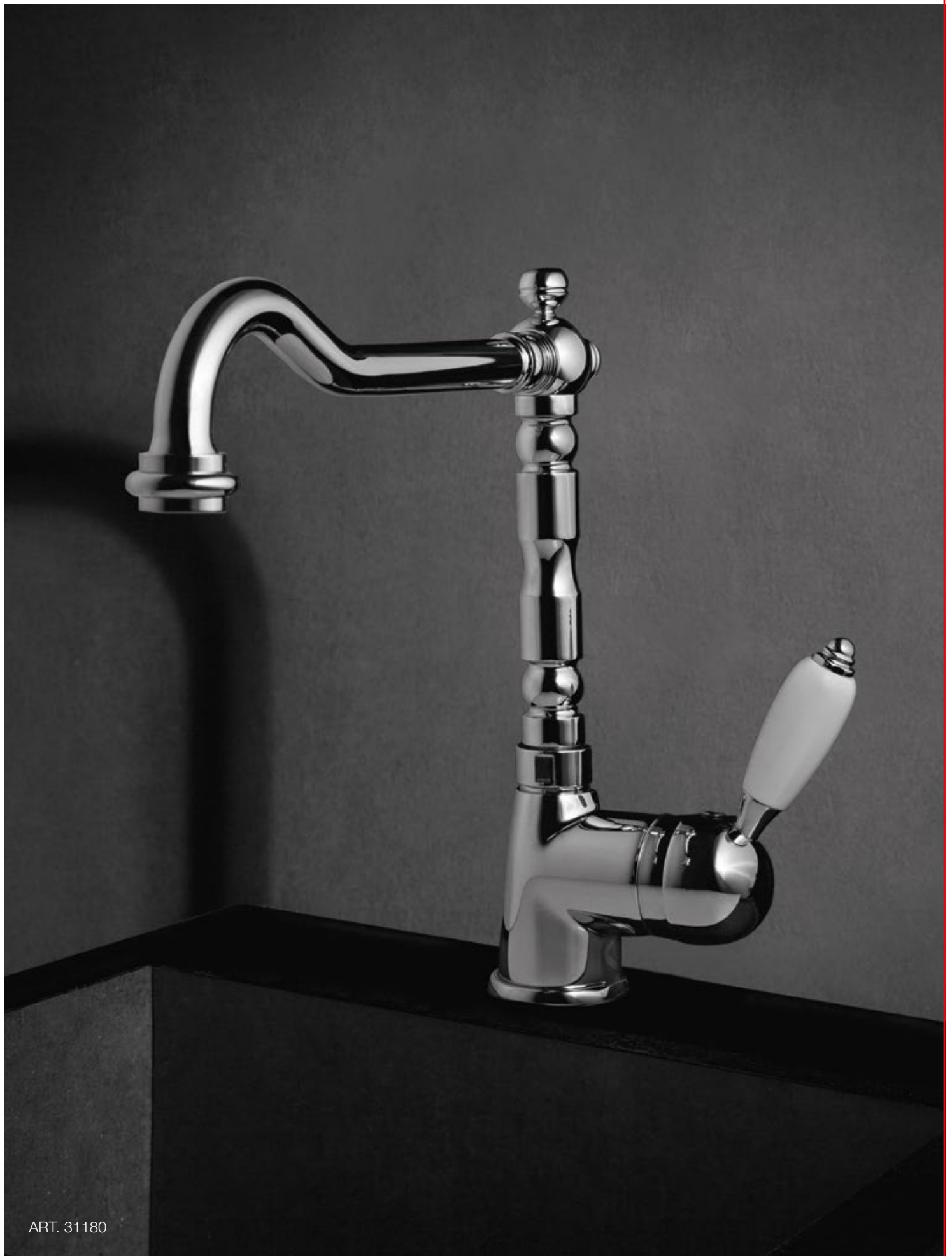

ART. 31180



ART. 32180



ART. 10150



ART. 30158

LAVELLO  
SINK

**30188**

Monocomandoavello con deviatore, canna e doccia orientabili  
*Deck sink single lever mixer with diverter adjustable spout and handshower*  
• 0,3728

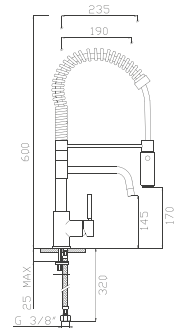

**30189**

Monocomandoavello con doccia orientabile  
*Deck sink single lever mixer with adjustable handshower*  
• 0,2986

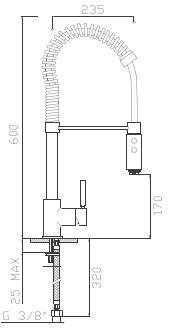

**30187**

Monocomandoavello con doccia estraibile  
*Deck sink single lever mixer with extractable shower*  
• 0,2889

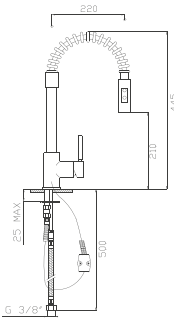

**30167**

Monocomandoavello  
*Deck sink single lever mixer*  
• 0,3648

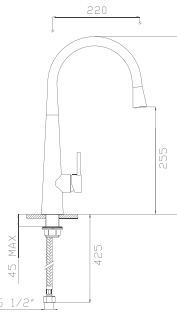

**14191**

Monocomandoavello  
*Deck sink single lever mixer*  
• 0,2800

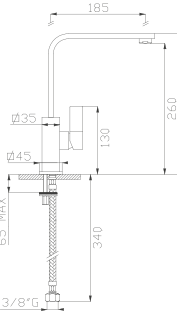

**15170**

Monocomandoavello  
*Deck sink single lever mixer*  
• 0,2625

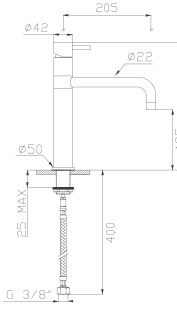

**30181**

Monocomandoavello  
*Deck sink single lever mixer*  
• 0,2156

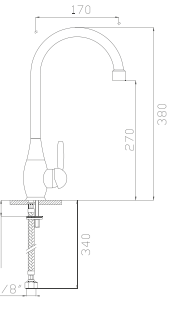

**30190**

Monocomandoavello reclinabile  
*Reclinable deck sink single lever mixer*  
• 0,2235

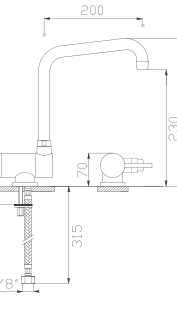

**30168**

Monocomandoavello con doccia orientabile  
*Deck sink single lever mixer with adjustable handshower*  
• 0,3000

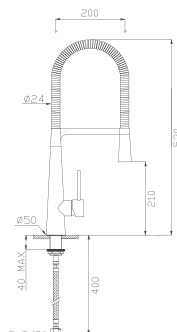

**30160**

Monocomandoavello con flessibile in gomma e doccia orientabile  
*Deck sink single lever mixer with rubber flexible hose and adjustable handshower*  
• 0,2300

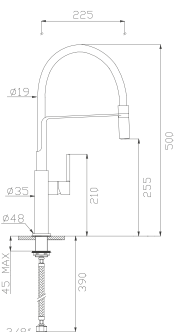

**30159**

Monocomandoavello  
*Deck sink single lever mixer*  
• 0,2209

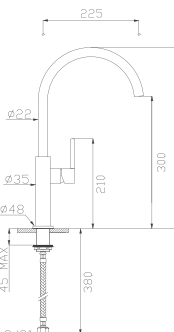

**30192**

Monocomandoavello  
*Deck sink single lever mixer*  
• 0,1829

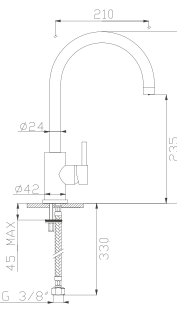

**30180**

Gruppoavello monoforo  
*Deck sink single hole mixer*  
• 0,1476

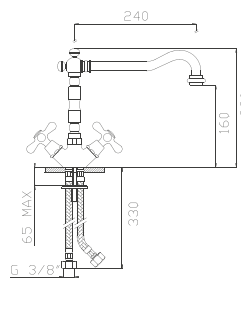

**31180**

Monocomandoavello  
*Deck sink single lever mixer*  
• 0,1599

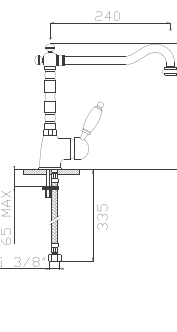

**32180**

Monocomandoavello con leva Swarovski  
*Deck sink single lever mixer with Swarovski lever*  
• 0,2050

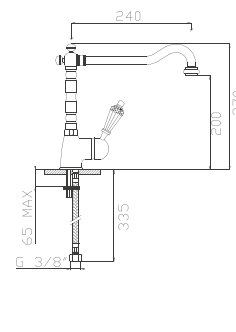

**10150**

Gruppoavello a muro  
*Wall mounted sink mixer*  
• 0,1281

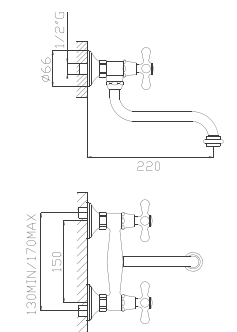

LAVELLO  
SINK

**30158**

Monocomandoavello  
con doccia estraibile  
*Deck sink single lever  
mixer with extractable  
shower*  
• 0,1467

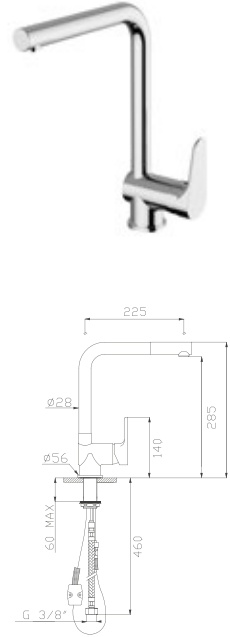

**30176**

Monocomandoavello  
con doccia estraibile  
*Deck sink single lever  
mixer with extractable  
shower*  
• 0,1564

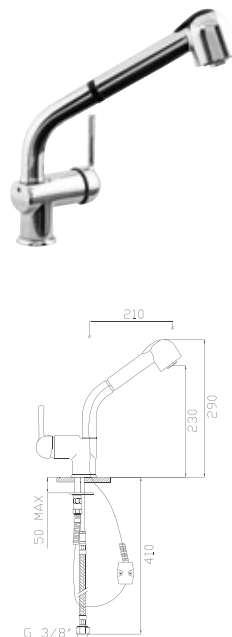

**30177**

Monocomandoavello  
con doccia estraibile  
*Deck sink single lever  
mixer with extractable  
shower*  
• 0,1405

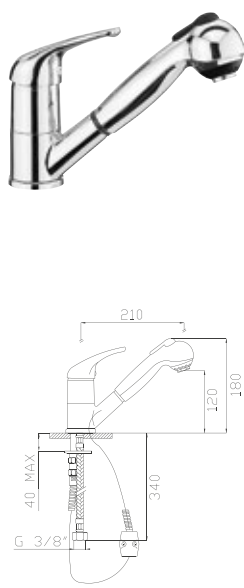

**30184**

Monocomandoavello  
tre vie **per acqua potabile**  
*Three way deck sink  
single lever mixer for  
drinkable water*  
• 0,1705

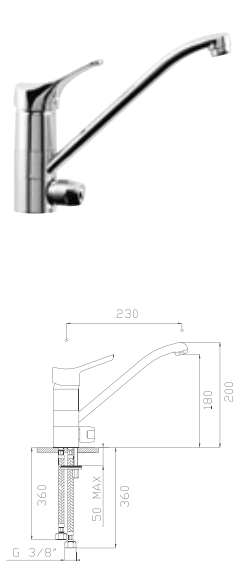

**30163-C5**

Monocomandoavello  
corpo Ø 50  
con leva prolungata  
*Deck sink single lever  
mixer body Ø 50  
with long lever*  
• 0,0923

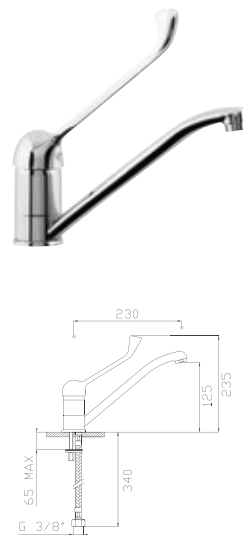

**11171**

Monocomandoavello,  
canna americana  
*Deck sink single lever  
mixer with American type  
spout*  
• 0,0864



**22171**

Monocomandoavello,  
canna americana  
*Deck sink single lever  
mixer with American type  
spout*  
• 0,0864



**25171**

Monocomandoavello,  
canna americana  
*Deck sink single lever  
mixer with American type  
spout*  
• 0,0864

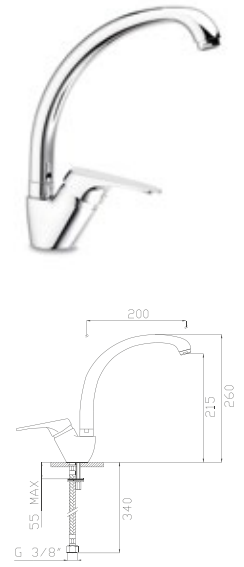

**30184AL**

Monocomandoavello  
tre vie **per attacco lavatrice**  
*Three way deck sink  
single lever mixer for  
washing machine*  
• 0,1705

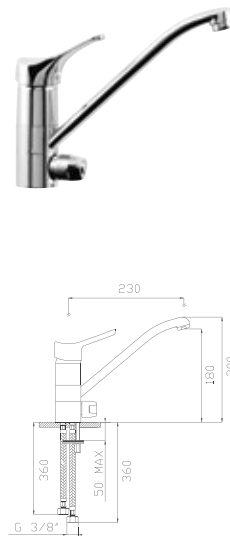

**P30172**

Monocomandoavello  
canna Ø 18  
*Deck sink single lever  
mixer with spout Ø 18*  
• 0,0928

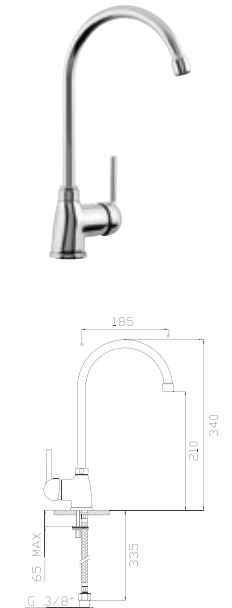

**P30170**

Monocomandoavello  
canna Ø 18  
*Deck sink single lever  
mixer with spout Ø 18*  
• 0,0628

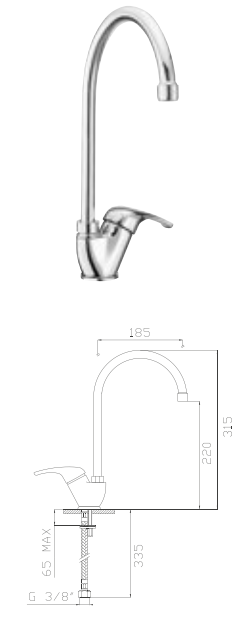

**P30171**

Monocomandoavello  
canna Ø 22  
*Deck sink single lever  
mixer with spout Ø 22*  
• 0,0783

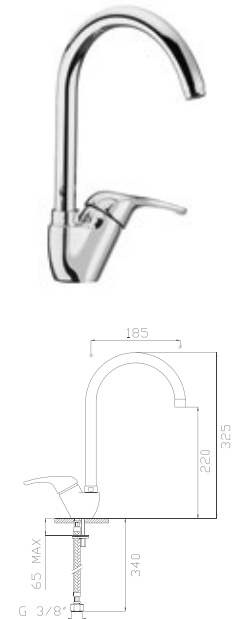

**J30171**

Monocomandoavello,  
canna americana  
*Deck sink single lever  
mixer with American type  
spout*  
• 0,0864

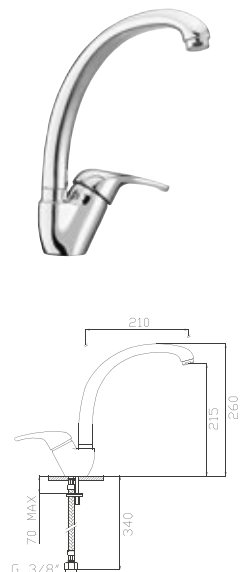

**11163**

Monocomandoavello  
corpo Ø 50  
*Deck sink single lever  
mixer body Ø 50*  
• 0,0629

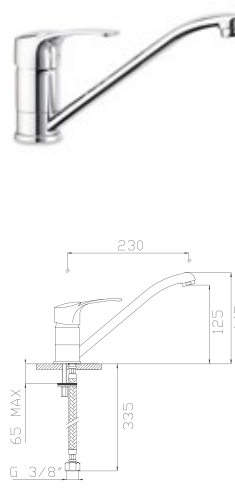

**22163**

Monocomandoavello  
corpo Ø 50  
*Deck sink single lever  
mixer body Ø 50*  
• 0,0629

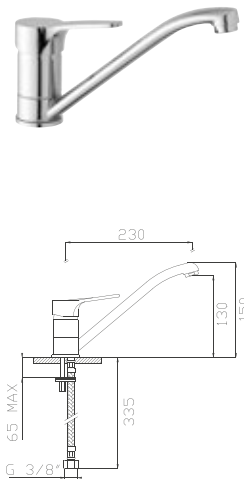

**25163**

Monocomandoavello  
corpo Ø 50  
*Deck sink single lever  
mixer body Ø 50*  
• 0,0629

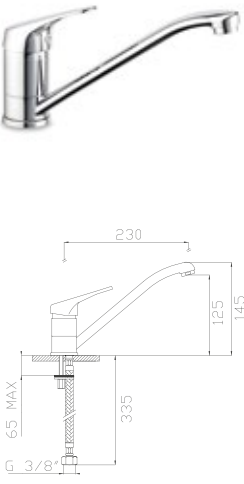



LAVELLO  
SINK

**30163**

Monocomandoavello  
corpo Ø 50

*Deck sink single lever  
mixer body Ø 50*

- 0,0629

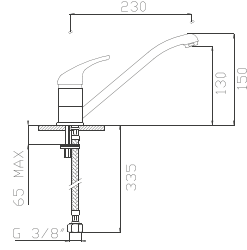

**11150**

Monocomandoavello a  
muro

*Wall mounted sink single  
lever mixer*

- 0,0990

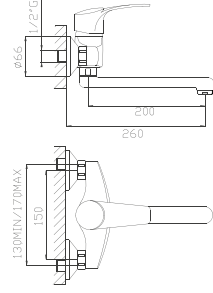

**22150**

Monocomandoavello a  
muro

*Wall mounted sink single  
lever mixer*

- 0,0990

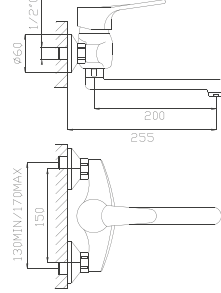

**25150**

Monocomandoavello a  
muro

*Wall mounted sink single  
lever mixer*

- 0,0990

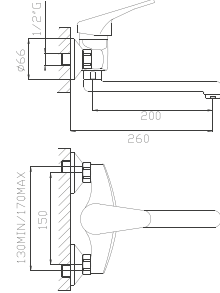

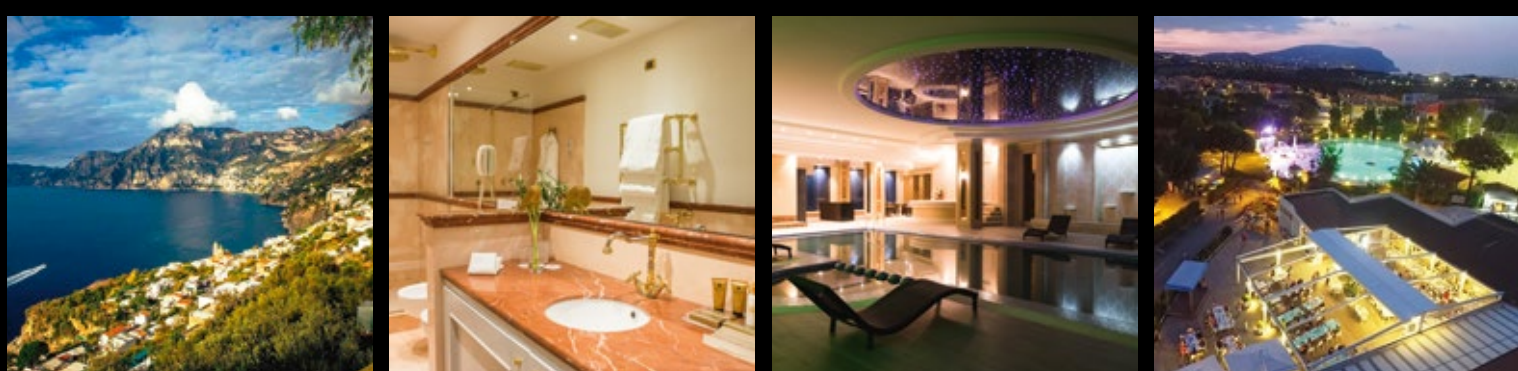
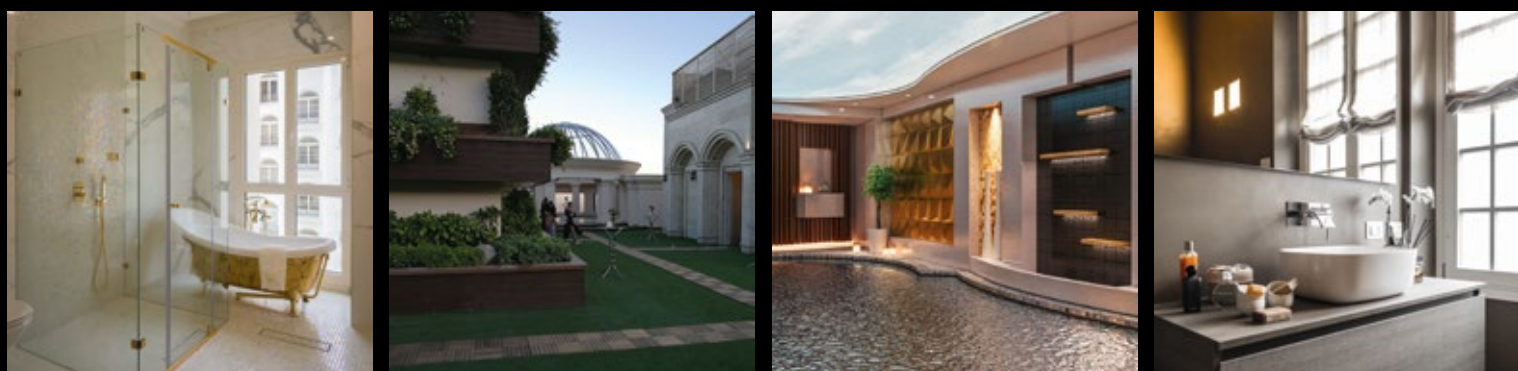

**ARAM PALACE** - TEHERAN, IRAN

**KOUROSH PALACE** - TEHERAN, IRAN

**LILIUM PARK** - TEHERAN, IRAN

**MARVASIYOUN** - TEHERAN, IRAN

**SAYEH PALACE** - TEHERAN, IRAN

**BENTLEY VILLAS** - THE WORLD OF DUBAI – DUBAI

**ZAFERANIYE BUILDING** - TEHERAN, IRAN

**UNDICILANDIA HOME** - BRESCIA, ITALY

**BORGO MARCONI VILLAS** - MONTICHIARI, ITALY

**DUE TORRI HOTEL** - VERONA, ITALY

**DOSSO ALTO RESTAURANT AND SPA** - MANIVA PASS, ITALY

**MARGHERITA HOTEL** - COSTIERA AMALFITANA, ITALY

**POIANO HOTEL** - COSTERMANO GARDA, ITALY

**PRIVATE VILLA** - BRESCIA, ITALY

**RESIDENCE NUMANA BLU** - RIVIERA DEL CONERO, ITALY

**RESIDENCE VILLA ARTIC** - MAZZIN DI FASSA, ITALY

**PARAMI SPARK PALACE** - TEHERAN, IRAN

**KABIRIZADEH LUXOR PROPERTY** - TEHERAN, IRAN

WE ARE  
**WHAT**  
WE SAY  
WE ARE

L'azienda costruttrice, nell'ambito del continuo miglioramento del prodotto, si riserva il diritto di apportare in qualsiasi momento, senza preavviso, modifiche alle caratteristiche tecniche ed agli accessori dei propri modelli. Le dotazioni descritte o fotografate nel presente catalogo sono solo indicative.

*The factory focusing on the product improvement, reserves the right to make changes to the specifications of its models and accessories at any time, without any notice. Therefore descriptions or pictures in this catalogue could be approximate.*

Credits  
Creative Concept - Graphic & Photo **Visualevent**  
Printing - Binding **Graficasette**

A special thanks goes to  
**Iser - Olympia - Simas - Stilhaus - Studio Odeon**





Via Bernocchi, 56 - 25069 Villa Carcina (Brescia) ITALY  
Ph. +39 030 8900961 r.a. - Fax +39 030 8900236



[www.ffmpegrubinetterie.com](http://www.ffmpegrubinetterie.com) - [info@ffmpegrubinetterie.com](mailto:info@ffmpegrubinetterie.com)