



ACQUA BENESSERE 01

LISTINO PREZZI / *PRICE LIST*

Colacril

“Abbi buona cura del tuo corpo,
è l'unico posto in cui devi vivere...”

Take care of your body;
it is the only place you have to live...

Jim Rohn

LISTINO PREZZI
PRICE LIST
06_2018

Colacril
ACQUA BENESSERE

MINIPISCINE E VASCHE SPA AND BATHTUBS



p. 5
**MINIPISCINE
SPA**



p. 11
**VASCHE
CON CASCATA**
Bathtubs with Waterfall



p. 17
**VASCHE
SHARM**
Sharm Bathtubs



p. 29
**VASCHE
CLASSIC**
Classic Bathtubs



p. 51
**VASCHE
FREE-STANDING**
Free-Standing Bathtubs



p. 59
**VASCHE
COMBinate**
*Bathtubs with
enclosures*

LA NATURA CAMBIA COLORE NATURE CHANGES ITS COLORS

Colacril offre per i gusci e i pannelli 4 varianti di colore in finitura Velvet oltre al classico Bianco Lucido per le Vasche Classic.

Colacril offers bathtub shells and skirts in four different Velvet colors in addition to the classic Glossy White finish, suitable for traditional bathtubs.



bianco lucido
glossy white

FINITURE VELVET / VELVET COLORS



bianco velvet
white velvet



avorio velvet
ivory velvet



nero velvet
black velvet



grigio chiaro velvet
light grey velvet



P. 8-14-64-76
**SISTEMI
IDROMASSAGGIO**
*HYDRO-MASSAGE
SYSTEMS*

CABINE E SOLUZIONI DOCCIA SHOWER ENCLOSURES AND SHOWER SOLUTIONS



p. 67
**CABINE
MULTIFUNZIONE**
*Multi-function shower
enclosures*



p. 79
PIATTI DOCCIA
Shower trays



p. 105
**PANNELLI DI
RIVESTIMENTO**
Wall covering panels



p. 109
**BOX DOCCIA
8 MM**
8 mm Shower enclosures



p. 119
**BOX DOCCIA
6 MM**
6 mm Shower enclosures



p. 155
COLONNE DOCCIA
Shower Columns



p. 162
ACCESSORI
Accessories

Tutti i materiali di Colacril *All of Colacril's materials*



p. 52
Il Polyminer.
Tra purezza e resistenza.
Polyminer.
Between purity and strength.



p. 96
L'Acrylic.
Sofisticata lucentezza.
Acrylic.
Sophisticated brilliance.



p. 80
Il Marmoresina
nei piatti doccia.
Marble-resin
in the shower trays.



MINIPISCINE SPA

TROPICANA 2130x2130x h 910

pag. 6

BEACH 2020x2020x h 870

pag. 6

CARIBE 2000x2000x h 910

pag. 7

PALM 2130x1600x h 750

pag. 7

SISTEMI IDROMASSAGGIO
HYDRO-MASSAGE SYSTEM

pag. 8

TROPICANA

2130x2130x h 910 mm (1300 lt) 325 kg

Cod. WMP22821897

€ 14.500,00

Pannelli inclusi sui 4 lati
4 sides skirts includedGUSCIO: LUCITE 6,3 MM - GRIGIO EFFETTO METAL
PANNELLATURA: EFFETTO LEGNO GRIGIOSHELL: LUCITE 6,3 MM - METAL GREY
SKIRTS: WOOD EFFECT - GREY

5 sedute + 1 lettino

Cuscini: n. 6

Getti: n. 92

Gejser centrale: n. 1

Regolatori aria: n. 4

Scarico acqua: 3/4"

Deviatori: n. 1

Pannello di controllo: Balboa TP600

Filtri antibatterici: n. 1

Disinfezione ad ozono

Cromoterapia perimetrale: n. 12 LED

Riscaldatore: 3 kW

Configurazione amperaggio: 32 A - 7,7 kW - 400 V - 50 Hz

16 A - 4,7 / 3 kW - 230 V - 50 Hz

Sistema hi-fi bluetooth: n. 4 altoparlanti

Isolamento termico: 10 mm

Blower silenzioso

Copertura termica grigio antracite

COPERTURA TERMICA
THERMAL COVERSCALA IN PVC / PVC STAIR
Cod. SCASPA01

€ 418,00

BEACH

2020x2020x h 870 mm (1300 lt) 300 kg

Cod. WMP22022097

€ 10.700,00

Pannelli inclusi sui 4 lati
4 sides skirts includedGUSCIO: LUCITE 6,3 MM - GRIGIO EFFETTO METAL
PANNELLATURA: EFFETTO LEGNO GRIGIOSHELL: LUCITE 6,3 MM - METAL GREY
SKIRTS: WOOD EFFECT - GREY

3 sedute + 2 lettini

Cuscini: n. 3

Getti: n. 45

Regolatori aria: n. 3

Scarico acqua: 3/4"

Deviatori: n. 1

Pannello di controllo: Balboa TP600

Filtri antibatterici: n. 1

Disinfezione ad ozono

Cromoterapia perimetrale: n. 6 LED

Riscaldatore: 3 kW

Configurazione amperaggio: 32 A - 7,4 kW - 400 V - 50 Hz

16 A - 4,4 / 3 kW - 230 V - 50 Hz

Sistema hi-fi bluetooth: n. 2 altoparlanti

Isolamento termico: 10 mm

Copertura termica grigio antracite

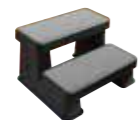
COPERTURA TERMICA
THERMAL COVERSCALA IN PVC / PVC STAIR
Cod. SCASPA01

€ 418,00

ACCESSORI / ACCESSORIES

KIT SALI DELLA SALUTE (2lt) / KIT HEALTH SALTS (2lt)

Cod. SALDSAL

€ 46,00

RIDUTTORE LIQUIDO DEL PH / PH LIQUID REDUCER

Cod. RIDPH

€ 20,00

SANIFICANTE IN PASTIGLIE 1,2kg/ DISINFECTION PILLS

Cod. SANPAST

€ 70,00

ANTIALGA AZZURRENTE E SCHIARENTE /
WHITENING ANTI-ALGAE**Cod. ANTAZZSCH**

€ 29,00



Disponibile il NUOVO KIT **HEALTH SALTS**, "Sali della Salute" una miscela che dona alla comune acqua concentrazioni adeguate dei 3 sali Magnesio, Potassio e Sodio.

The NEW **HEALTH SALT KITS** "Health Salts" a formula which permits common water to receive a correct concentration of three salts; Magnesium, Potassium and Sodium.

CARIBE

2000x2000x h 910 mm (1100 lt) 300 kg

Cod. WMP22022092

€ 10.700,00

Pannelli inclusi sui 4 lati
4 sides skirts includedGUSCIO: LUCITE 6,3 MM - GRIGIO EFFETTO METAL
PANNELLATURA: EFFETTO LEGNO GRIGIOSHELL: LUCITE 6,3 MM - METAL GREY
SKIRTS: WOOD EFFECT - GREY

5 sedute + 1 lettino

Cuscini: n. 3

Getti: n. 46

Fontane: n. 2

Regolatori aria: n. 4

Scarico acqua: 3/4"

Deviatori: n. 1

Pannello di controllo: Balboa VL260

Filtri antibatterici: n. 1

Disinfezione ad ozono

Cromoterapia perimetrale: n. 15 LED

Riscaldatore: 2 kW

Potenza: 4,4 kW - 230 V - 50 Hz

Sistema hi-fi bluetooth: n. 2 altoparlanti

Isolamento termico: 10 mm

Portaghiaccio e portabibite

Copertura termica grigio antracite

COPERTURA TERMICA
THERMAL COVERSCALA IN PVC / PVC STAIR
Cod. SCASPA01

€ 418,00

PALM

2010x1530x h 770 mm (720 lt) 280 kg

Cod. WMP21015281

€ 9.140,00

Pannelli inclusi sui 4 lati
4 sides skirts includedGUSCIO: LUCITE 6,3 MM - GRIGIO EFFETTO METAL
PANNELLATURA: EFFETTO LEGNO GRIGIOSHELL: LUCITE 6,3 MM - METAL GREY
SKIRTS: WOOD EFFECT - GREY

2 sedute + 1 lettino

Cuscini: n. 3

Getti: n. 31

Regolatori aria: n. 3

Scarico acqua: 3/4"

Deviatori: n. 1

Pannello di controllo: Balboa VL260

Filtri antibatterici: n. 1

Disinfezione ad ozono

Cromoterapia perimetrale: n. 10 LED

Riscaldatore: 2 kW

Potenza: 4,2 kW - 230 V - 50 Hz

Sistema hi-fi bluetooth: n. 2 altoparlanti

Isolamento termico: 10 mm

Copertura termica grigio antracite

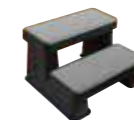
COPERTURA TERMICA
THERMAL COVERSCALA IN PVC / PVC STAIR
Cod. SCASPA01

€ 418,00

ACCESSORI / ACCESSORIES

KIT SALI DELLA SALUTE (2lt) / KIT HEALTH SALTS (2lt)

Cod. SALDSAL

€ 46,00

RIDUTTORE LIQUIDO DEL PH / PH LIQUID REDUCER

Cod. RIDPH

€ 20,00

SANIFICANTE IN PASTIGLIE 1,2kg/ DISINFECTION PILLS

Cod. SANPAST

€ 70,00

ANTIALGA AZZURRENTE E SCHIARENTE /
WHITENING ANTI-ALGAE**Cod. ANTAZZSCH**

€ 29,00



Disponibile il NUOVO KIT **HEALTH SALTS**, "Sali della Salute" una miscela che dona alla comune acqua concentrazioni adeguate dei 3 sali Magnesio, Potassio e Sodio.

The NEW **HEALTH SALT KITS** "Health Salts" a formula which permits common water to receive a correct concentration of three salts; Magnesium, Potassium and Sodium.

SISTEMI IDROMASSAGGIO

HYDRO-MASSAGE SYSTEMS

// SISTEMI IDROMASSAGGIO_HYDRO-MASSAGE SYSTEMS

MINIPISCINE / SPA

SISTEMA/SYSTEM BALBOA TP600

Mod. TROPICANA
Mod. BEACH

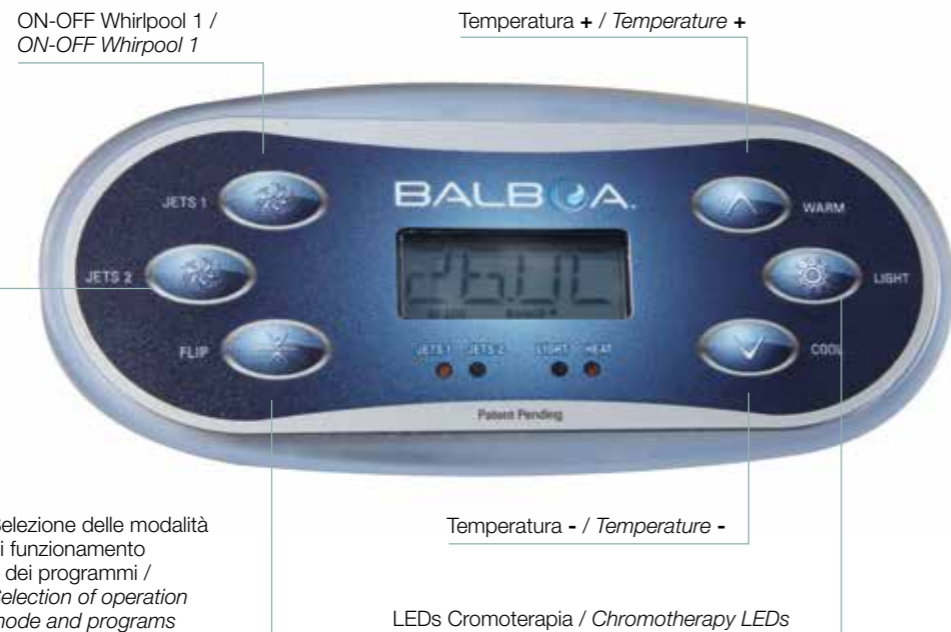

SISTEMA/SYSTEM BALBOA VL260

Mod. CARIBE
Mod. PALM



GETTI IDROMASSAGGIO HYDROMASSAGE JETS

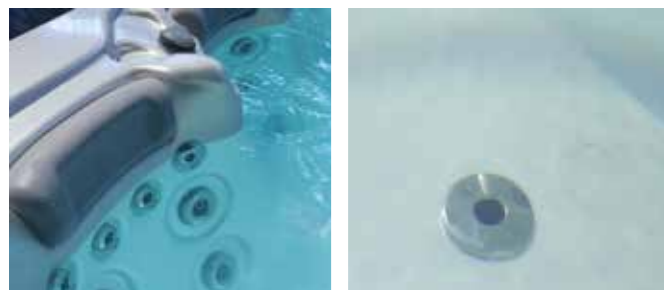

Getto Whirlpool
Whirlpool Jet

Getto Airpool
Airpool nozzle

FILTRO ANTIBATTERICO / ANTI-BACTERIAL FILTERS



Sistema di filtraggio acqua
Water filtering system

GETTI IDROMASSAGGIO HYDROMASSAGE JETS

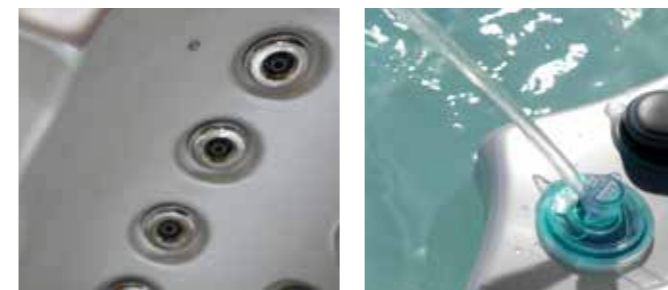

Getto Whirlpool
Whirlpool Jet

Fontana Retroilluminata (CARIBE)
Backlit fountain (CARIBE)

KIT SALI DELLA SALUTE KIT HEALTH SALTS



Disponibile per tutte le Minipiscine il NUOVO KIT **HEALTH SALTS**. "Sali della Salute" una miscela che dona alla comune acqua concentrazioni adeguate dei 3 sali Magnesio, Potassio e Sodio.

The NEW **HEALTH SALT KITS** "Health Salts" are available, a mixture that gives common water an adequate concentration of 3 salts: Magnesium, Potassium and Sodium.

CROMOTERAPIA CHROMOTHERAPY



Cromoterapia perimetrale a LEDs
LED perimeter chromotherapy

IMPIANTO AUDIO AUDIO SYSTEM



Altoparlante
Speaker

CROMOTERAPIA CHROMOTHERAPY



Cromoterapia perimetrale a LEDs
LED perimeter chromotherapy

IMPIANTO AUDIO AUDIO SYSTEM



Altoparlante
Speaker

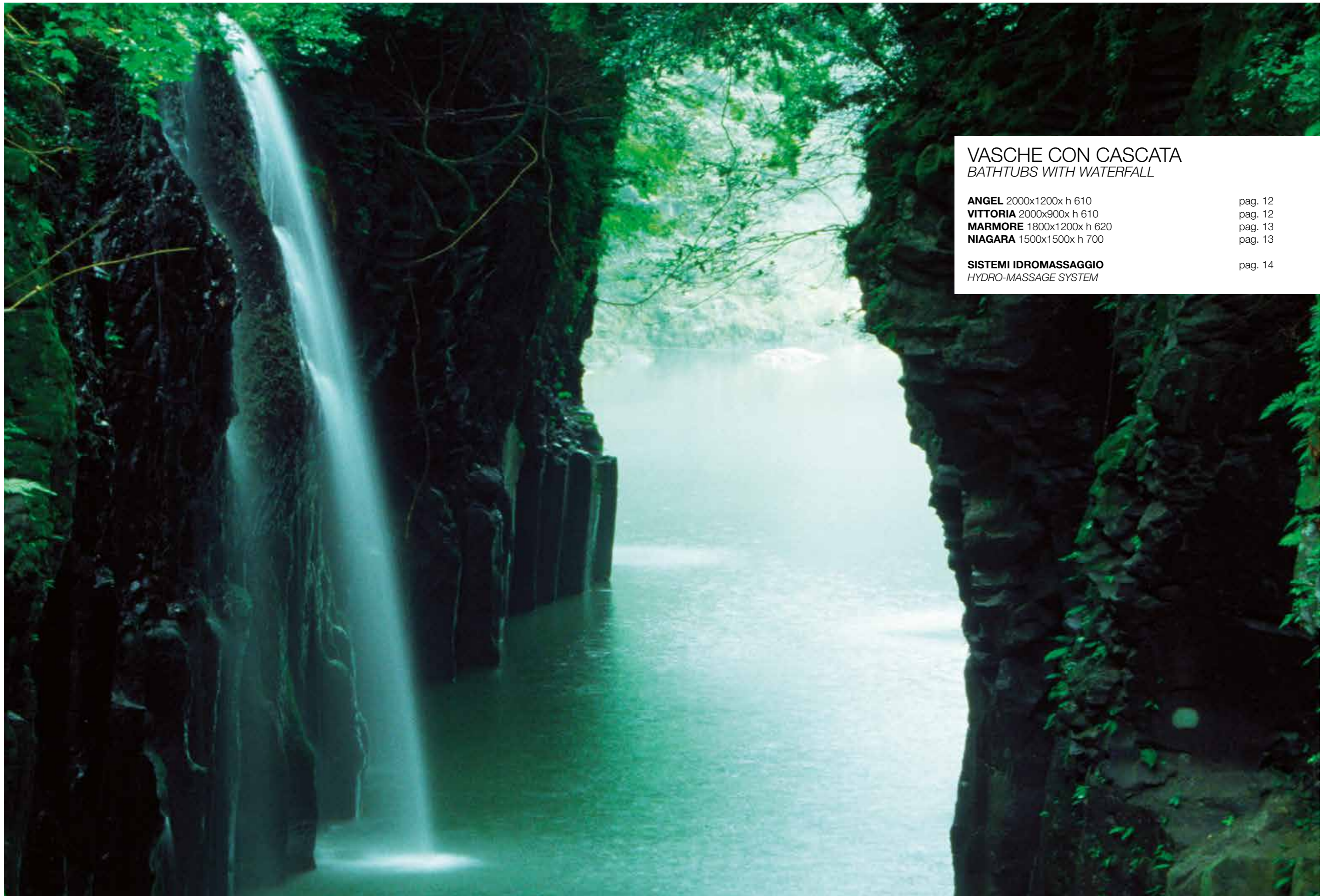

VASCHE CON CASCATA
BATHTUBS WITH WATERFALL

ANGEL 2000x1200x h 610

pag. 12

VITTORIA 2000x900x h 610

pag. 12

MARMORE 1800x1200x h 620

pag. 13

NIAGARA 1500x1500x h 700

pag. 13

SISTEMI IDROMASSAGGIO

pag. 14

HYDRO-MASSAGE SYSTEM

ANGEL

2000x1200x h 610 mm (230 lt) 163 kg

Cod. **VIMAR200120** Guscio e Telaio / Shell and Frame

€ 7.250,00
Pannelli non inclusi
Skirts not included

VITTORIA

2000x900x h 610 mm (150 lt) 140 kg

Cod. **VIMAR20090** Guscio e Telaio / Shell and Frame

€ 5.490,00
Pannelli non inclusi
Skirts not included

GUSCIO : ACRILICO BIANCO
PANNELLI : MDF BIANCO LACCATO LUCIDO

SHELL : WHITE ACRYLIC
SKIRT: MDF GLOSSY WHITE



ANGEL



VITTORIA

Cuscini: n. 2
Getti whirlpool: n. 10 (ANGEL)
Getti whirlpool: n. 8 (VITTORIA)
Getti airpool: n. 8
Getto a cascata: n. 2
Getto a fontana: n. 2 (ANGEL)

Cushions: n. 2
Whirlpool jets: n. 10 (ANGEL)
Whirlpool jets: n. 10 (VITTORIA)
Airpool jets: n. 8
Waterfalls: n. 2
Fountain jets: n. 2 (ANGEL)

Rubinetteria bordo vasca a scomparsa retroilluminata
Deviatore a 3 vie - Doccino - Bocca riempimento vasca
Riempimento da getti whirlpool
Miscelatore
Colonna di scarico montata

Concealable and backlit water taps
Three-way diverter, hand shower, bathtub fill spout,
Bath water fill through the whirlpool jets
Mixer
Overflow installed

Pannello di controllo: Touch retroilluminato
Sonda di livello
Cromoterapia su jets airpool
Potenza: 1.88 kW - 220 V - 50 Hz

Backlit touch control panel
Water level sensor
Airpool jets with chromotherapy
Power consumption: 1.88 kW - 220V - 50 Hz

PANNELLI IN LEGNO LACCATO BIANCO LACQUERED WHITE WOODEN SKIRTS

Cod. AN01	Angolo / Corner	€ 330,00
Cod. ANGPAN200	Pannello / Skirt 2000 mm	€ 500,00
Cod. ANGPAN120	Pannello / Skirt 1200 mm	€ 400,00
Cod. VITPAN90	Pannello / Skirt 900 mm	€ 250,00

! SPECIFICARE SEMPRE LA COMPOSIZIONE DEI PANNELLI ALL'ORDINE
ALWAYS SPECIFY THE PANELS COMPOSITION WHEN PLACING THE ORDER



! COMPOSIZIONE PANNELLI / SKIRTS COMPOSITIONS - ANGEL, VITTORIA, MARMORE

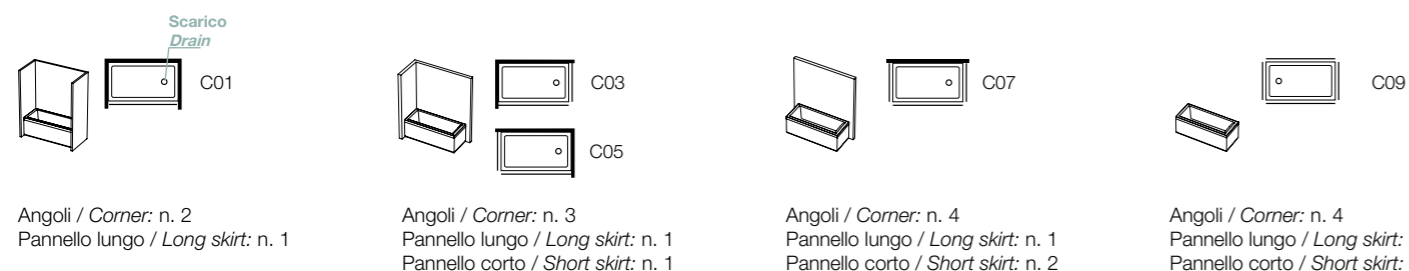

MARMORE

1800x1200x h 620 mm (250 lt) 140 kg

Cod. **VIMAR180120** Guscio e Telaio / Shell and Frame

€ 5.130,00
Pannelli non inclusi
Skirts not included

GUSCIO : ACRILICO BIANCO
PANNELLI : MDF BIANCO LACCATO LUCIDO

SHELL : WHITE ACRYLIC
SKIRT: MDF GLOSSY WHITE



Cuscini: n. 2
Getti whirlpool: n. 8
Getti airpool: n. 8
Getto a cascata: n. 1
Rubinetteria bordo vasca
Bocca riempimento vasca a cascata
Miscelatore
Regolatore di pressione
Doccino estraibile
Pannello di controllo LCD: Touch retroilluminato
Sonda di livello
Cromoterapia su jets airpool
Radio digitale FM - MP3 - Bluetooth
Sistema disinfezione ad ozono
Potenza: 1.5 kW - 220 V - 50 Hz

Cushions: n. 2
Whirlpool jets: n. 8
Airpool jets: n. 8
Waterfall: n. 1
Deck mounted water taps
Bath waterfall fill spout
Mixer
Pressure regulator
Extractable hand shower
Touch backlit LCD control panel
Water level sensor
Airpool jets with LED chromotherapy
FM radio, MP3 and Bluetooth entertainment system
Ozone disinfection system
Power: 1.5 kW - 220V - 50 Hz

PANNELLI IN LEGNO LACCATO BIANCO LACQUERED WHITE WOODEN SKIRTS

Cod. AN02	Angolo / Corner	€ 330,00
Cod. MARPAN180	Pannello / Skirt 1800 mm	€ 440,00
Cod. MARPAN120	Pannello / Skirt 1200 mm	€ 400,00

! SPECIFICARE SEMPRE LA COMPOSIZIONE DEI PANNELLI ALL'ORDINE
ALWAYS SPECIFY THE PANELS COMPOSITION WHEN PLACING THE ORDER

NIAGARA

1500x1500x h 700 mm (380 lt) 128 kg

Cod. **VIMAR150150** Guscio e Telaio / Shell and Frame

€ 6.960,00
Pannelli non inclusi
Skirts not included

GUSCIO E PANNELLI : ACRILICO BIANCO

SHELL AND SKIRT: WHITE ACRYLIC



Cuscini: n. 2
Getti whirlpool: n. 23
Getti airpool: n. 8
Getto a cascata: n. 1
Rubinetteria bordo vasca
Bocca riempimento vasca a cascata
Miscelatore
Doccino estraibile
Pannello di controllo LCD: Touch retroilluminato
Sonda di livello
Cromoterapia su jets airpool
Radio digitale FM - MP3 - Bluetooth
Sistema disinfezione ad ozono
Potenza: 1.5 kW - 220 V - 50 Hz

Cushions: n. 2
Whirlpool jets: n. 23
Airpool jets: n. 8
Circular waterfall: n. 1
Deck mounted water taps
Bath waterfall fill spout
Mixer
Extractable hand shower
Touch backlit LCD control panel
Water level sensor
Airpool jets with LED chromotherapy
FM radio, MP3 and Bluetooth entertainment system
Ozone disinfection system
Power: 1.5 kW - 220V - 50 Hz

PANNELLO IN ACRILICO ACRYLIC SKIRT

Cod. NIAPAN150	Pannello / Skirt	€ 310,00
-----------------------	------------------	----------

VASCHE CON CASCATA / BATHTUBS WITH WATERFALL

SISTEMA TOUCH RETROILLUMINATO BACKLIT TOUCH SYSTEM

Mod. ANGEL
Mod. VITTORIA

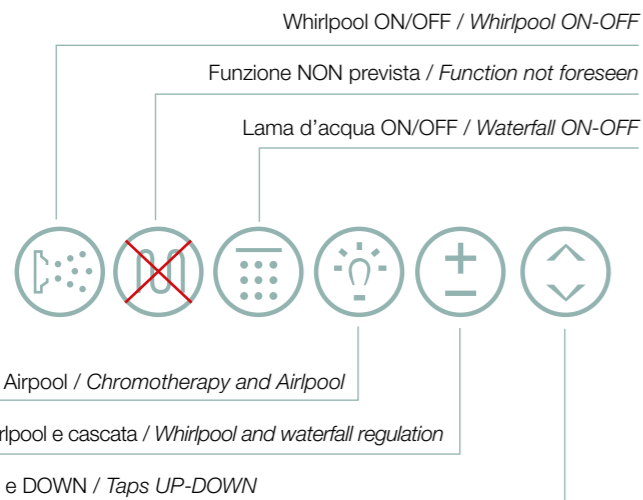

SPENTO / OFF



ACCESO / ON

TOUCH SCREEN LCD RETROILLUMINATO BACKLIT LCD TOUCH SCREEN

Mod. MARMORE
Mod. NIAGARA

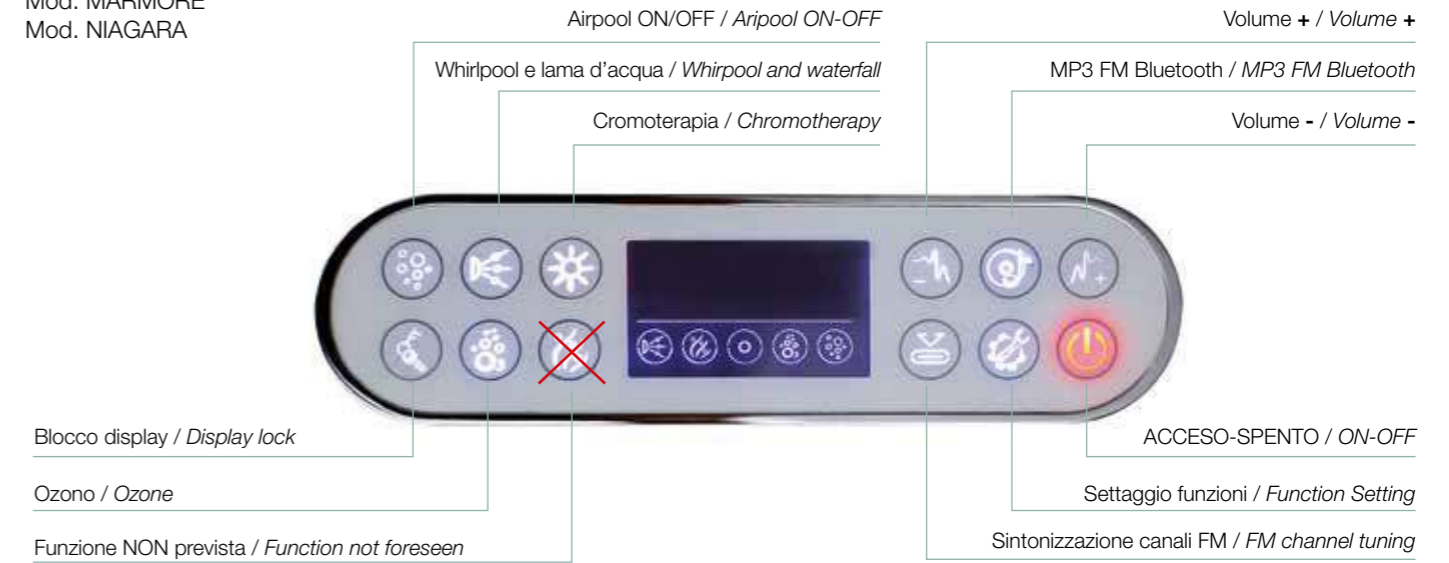

GETTI JETS



Getto whirlpool
Whirlpool jet



Getto airpool con cromoterapia
Airpool nozzle with chromotherapy



Lama d'acqua e bocca di erogazione
Waterfall and fill spout

GETTI JETS



Getto whirlpool
Whirlpool jet



Getto airpool con cromoterapia
Airpool nozzle with chromotherapy



Lama d'acqua
Waterfall

RUBINETTERIA A SCOMPARSA CONCEALED TAPS



Rubinetteria incassata
Recessed taps



Miscelatore, doccia e deviatore
Mixer, hand shower and diverter



Doccino estraibile
Extractable hand shower

RUBINETTERIA TAPS



Bocca di erogazione acqua
Fill spout



Lama d'acqua e miscelatore Whirlpool (solo mod. Marmore)
Waterfall and Whirlpool Air mixer (only mod. Marmore)



Miscelatore, deviatore e doccia estraibile
Mixer, diverter and extractable hand shower



VASCHE SHARM
SHARM BATHTUBS

Design Alessandro Paoletti

QUADRATA 1500x1500x h 680
ANGOLARE 1400x1400x h 600
ASIMMETRICA 1500x1000x h 600
RETTANGOLARE 1700x700x h 600
1800x800x h 600

pag. 18
pag. 20
pag. 22
pag. 24
pag. 26

SISTEMI IDROMASSAGGIO
HYDRO-MASSAGE SYSTEM

pag. 64



SHARM QUADRATA Design Alessandro Paoletti

1500X1500X h 680 mm (650 lt)

GUSCIO E PANNELLI : ACRILICO BIANCO



versione **SENZA IDROMASSAGGIO**
version **WITHOUT WHIRLPOOL**

	Cod.	Descrizione Description	Kg	Bianco White
	SHAG150150	Guscio Shell	48	€ 820,00
	SHAGT150150	Guscio e telaio Shell and frame	84	€ 1.155,00

versione **SISTEMA IDRO+**
IDRO+ SISTEM version



WHIRLPOOL + CROMOTERAPIA
WHIRLPOOL + CHROMOTHERAPY
(PAG. 62)
Whirlpool jets: n. 16

	Cod.	Descrizione Description	Kg	Bianco White
	SHAI150150	Guscio e telaio Shell and frame	108	€ 2.900,00

N.2 Motore Whirlpool / Whirlpool Pump: 1 Cv / 1 Hp
Sonda di livello / Level probe

versione **SISTEMA IDRO-TECNO**
IDRO-TECNO SISTEM version



WHIRLPOOL + AIRPOOL +
CROMOTERAPIA + DISINFEZIONE
WHIRLPOOL + AIRPOOL +
CHROMOTHERAPY + DISINFECTION
(PAG. 62)
Whirlpool jets: n. 16
Airpool jets: n. 18

	Cod.	Descrizione Description	Kg	Bianco White
	SHAIT150150	Guscio e telaio Shell and frame	146	€ 3.480,00

N.2 Motore Whirlpool / Whirlpool Pump: 1 Cv / 1 Hp
Motore Airpool / Airpool Pump: 650 Watt / Volts 220/230, 50-60 Hz
Sonda di livello / Level probe

N.B. Date le dimensioni della vasca abbiamo progettato il sistema idro della Sharm 1500x1500 con due circuiti whirlpool per mantenere un'esperienza di benessere totale.

NOTE: given the size of the bathtub we have engineered the whirlpool system of the sharm 1500x1500 with two whirlpool circuits in order to offer a total wellness experience.

PANNELLI SKIRTS



Cod.	Descrizione Description	Bianco White
SHAPAN150	Pannello Sharm 1500 mm Skirt	€ 210,00

! SPECIFICARE SEMPRE LA COMPOSIZIONE DEI PANNELLI ALL'ORDINE
ALWAYS SPECIFY THE PANELS COMPOSITION WHEN PLACING THE ORDER



COMPOSIZIONE PANNELLI / PANEL COMPOSITIONS

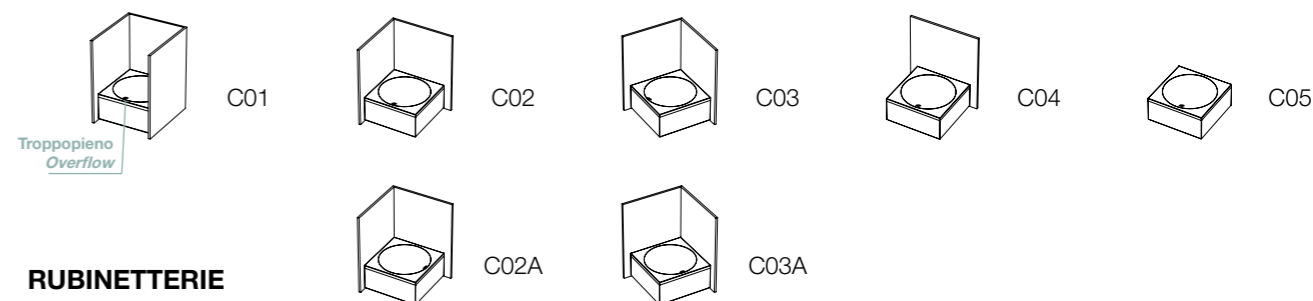

RUBINETTERIE TAPS



Cod.	Descrizione Description	Cromo Chrome
RUB4F	Rubinetteria 4 fori Tap 4 holes	€ 620,00
RUB3F	Rubinetteria 3 fori Tap 3 holes	€ 495,00
COLSCERO01	Colonna di scarico con erogatore Drain pipe with bath filler	€ 140,00
COLSCA01	Colonna di scarico Drain pipe	€ 77,00

NB: Le versioni con IDROMASSAGGIO comprendono sempre la colonna di scarico (cod. COLSCA01).
NOTE: The HYDRO-MASSAGE versions are always with drain pipe included (cod. COLSCA01).

ACCESSORI ACCESORIES



Cod.	Descrizione Description	Bianco White
PROFBV	Profilo bordo vasca Bath tub rim finish	€ 70,00
SHAPOG01	Poggiatesta Sharm QUADRATA Head rest	€ 72,00

SHARM ANGOLARE Design Alessandro Paoletti

1400X1400X h 600 mm (240 lt)

GUSCIO E PANNELLI : ACRILICO BIANCO



PANNELLI SKIRTS



Cod.	Descrizione Description	Bianco White
SHAANGPAN	Pannello Sharm ANGOLARE Skirt	€ 300,00

versione **SENZA IDROMASSAGGIO**
version **WITHOUT WHIRLPOOL**

Cod.	Descrizione Description	Kg	Bianco White
SHAG140140	Guscio Shell	48	€ 630,00
SHAGT140140	Guscio e telaio Shell and frame	84	€ 905,00

versione **SISTEMA IDRO+**
IDRO+ SISTEM version

Cod.	Descrizione Description	Kg	Bianco White
SHAI140140	Guscio e telaio Shell and frame	108	€ 1.900,00

Motore Whirlpool / Whirlpool Pump: 1 Cv / 1 Hp
Sonda di livello / Level probe

 WHIRLPOOL + CROMOTERAPIA
WHIRLPOOL + CHROMOTHERAPY
(PAG. 62)
Whirlpool jets: n. 6

versione **SISTEMA IDRO-TECNO**
IDRO-TECNO SISTEM version

Cod.	Descrizione Description	Kg	Bianco White
SHAIT140140	Guscio e telaio Shell and frame	146	€ 2.480,00

Motore Whirlpool / Whirlpool Pump: 1 Cv / 1 Hp
Motore Airpool / Airpool Pump: 650 Watt / Volts 220/230, 50-60 Hz
Sonda di livello / Level probe

 WHIRLPOOL + AIRPOOL + CROMOTERAPIA + DISINFEZIONE
WHIRLPOOL + AIRPOOL + CHROMOTHERAPY + DISINFECTION
(PAG. 62)
Whirlpool jets: n. 6
Airpool jets: n. 16

RUBINETTERIE TAPS



Cod.	Descrizione Description	Cromo Chrome
RUB4F	Rubinetteria 4 fori Tap 4 holes	€ 620,00
RUB3F	Rubinetteria 3 fori Tap 3 holes	€ 495,00
COLSCERO	Colonna di scarico con erogatore Drain pipe with bath filler	€ 120,00
COLSCA	Colonna di scarico Drain pipe	€ 60,00

NB: Le versioni con IDROMASSAGGIO comprendono sempre la colonna di scarico (cod. COLSCA).
NOTE: The HYDRO-MASSAGE versions are always with drain pipe included (cod. COLSCA).

ACCESSORI ACCESORIES



Cod.	Descrizione Description	Bianco White
PROFBV	Profilo bordo vasca Bath tub rim finish	€ 70,00
SHAPOG02	Poggiatesta Sharm ANGOLARE Head rest	€ 50,00

SHARM ASIMMETRICA Design Alessandro Paoletti

1500X1000X h 600 mm (220 lt)



SX - Left



DX - Right





versione **SENZA IDROMASSAGGIO**
version **WITHOUT WHIRLPOOL**

	Cod.	Descrizione Description	Kg	Bianco White
DX Right	 SHAG150100D	Guscio Shell	18	€ 425,00
SX Left	 SHAG150100S	Guscio Shell	18	€ 425,00
DX Right	 SHAGT150100D	Guscio e telaio Shell and frame	46	€ 680,00
SX Left	 SHAGT150100S	Guscio e telaio Shell and frame	46	€ 680,00

versione **SISTEMA IDRO+**
IDRO+ SISTEM version



WHIRLPOOL + CROMOTERAPIA
WHIRLPOOL + CHROMOTHERAPY
(PAG. 62)
Whirlpool jets: n. 7



	Cod.	Descrizione Description	Kg	Bianco White
DX Right	 SHAI150100D	Guscio e telaio Shell and frame	58	€ 1.680,00
SX Left	 SHAI150100S	Guscio e telaio Shell and frame	58	€ 1.680,00

Motore Whirlpool / Whirlpool Pump: 1 Cv / 1 Hp
Sonda di livello / Level probe

versione **SISTEMA IDRO-TECNO**
IDRO-TECNO SISTEM version



WHIRLPOOL + AIRPOOL + CROMOTERAPIA + DISINFEZIONE
WHIRLPOOL + AIRPOOL + CHROMOTHERAPY + DISINFECTION
(PAG. 62)
Whirlpool jets: n. 7
Airpool jets: n. 12

	Cod.	Descrizione Description	Kg	Bianco White
DX Right	 SHAIT150100D	Guscio e telaio Shell and frame	77	€ 2.254,00
SX Left	 SHAIT150100S	Guscio e telaio Shell and frame	77	€ 2.254,00

Motore Whirlpool / Whirlpool Pump: 1 Cv / 1 Hp
Motore Airpool / Airpool Pump: 650 Watt / Volts 220/230, 50-60 Hz
Sonda di livello / Level probe

PANNELLI SKIRTS

SX - Left



	Cod.	Descrizione Description	Bianco White
DX Right	SHAPANASIDX	Pannello Sharm ASIMMETRICA Skirt	€ 284,00
SX Left	SHAPANASISX	Pannello Sharm ASIMMETRICA Skirt	€ 284,00

RUBINETTERIE TAPS



	Cod.	Descrizione Description	Cromo Chrome
	RUB4F	Rubinetteria 4 fori Tap 4 holes	€ 620,00
	RUB3F	Rubinetteria 3 fori Tap 3 holes	€ 495,00
	COLSCERO	Colonna di scarico con erogatore Drain pipe with bath filler	€ 120,00
	COLSCA	Colonna di scarico Drain pipe	€ 60,00

NB: Le versioni con IDROMASSAGGIO comprendono sempre la colonna di scarico (cod. COLSCA).
NOTE: The HYDRO-MASSAGE versions are always with drain pipe included (cod. COLSCA).

ACCESSORI ACCESORIES



	Cod.	Descrizione Description	Bianco White
	PROFBV	Profilo bordo vasca Bath tub rim finish	€ 70,00
	SHAPOG02	Poggiatesta Sharm ASIMMETRICA Head rest	€ 50,00

SHARM RETTANGOLARE Design Alessandro Paoletti

1700X700X h 600 mm (220 lt)

SX - Left



DX - Right



PANNELLI SKIRTS

DX - Right



Cod.	Descrizione Description	Bianco White
SHAPAN170	Pannello Sharm 1700 mm Skirt	€ 230,00
SHAPANA70	Pannello Sharm 700 mm Skirt	€ 140,00

**! SPECIFICARE SEMPRE LA COMPOSIZIONE DEI PANNELLI ALL'ORDINE
ALWAYS SPECIFY THE PANELS COMPOSITION WHEN PLACING THE ORDER**

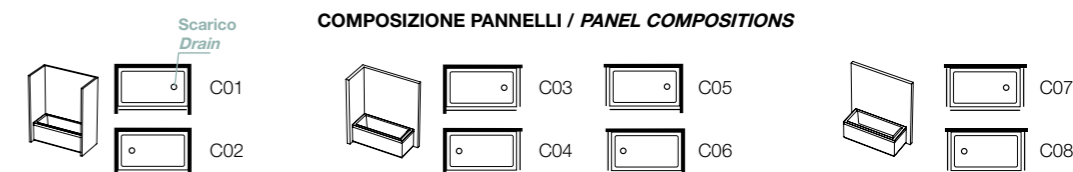

versione **SENZA IDROMASSAGGIO**
version **WITHOUT WHIRLPOOL**

	Cod.	Descrizione Description	Kg	Bianco White
	SHAG17070	Guscio Shell	17	€ 382,00
	SHAGT17070	Guscio e telaio Shell and frame	55	€ 623,00

RUBINETTERIE TAPS



Cod.	Descrizione Description	Cromo Chrome
RUB4F	Rubinetteria 4 fori Tap 4 holes	€ 620,00
RUB3F	Rubinetteria 3 fori Tap 3 holes	€ 495,00
COLSCERO	Colonna di scarico con erogatore Drain pipe with bath filler	€ 120,00
COLSCA	Colonna di scarico Drain pipe	€ 60,00

NB: Le versioni con IDROMASSAGGIO comprendono sempre la colonna di scarico (cod. COLSCA).
NOTE: The HYDRO-MASSAGE versions are always with drain pipe included (cod. COLSCA).

versione **SISTEMA IDRO+**
IDRO+ SISTEM version



WHIRLPOOL + CROMOTERAPIA
WHIRLPOOL + CHROMOTHERAPY
(PAG. 62)
Whirlpool jets: n. 6

	Cod.	Descrizione Description	Kg	Bianco White
DX Right	SHAI17070D	Guscio e telaio Shell and frame	69	€ 1.620,00
SX Left	SHAI17070S	Guscio e telaio Shell and frame	69	€ 1.620,00

Motore Whirlpool / Whirlpool Pump: 1 Cv / 1 Hp
Sonda di livello / Level probe

versione **SISTEMA IDRO-TECNO**
IDRO-TECNO SISTEM version



WHIRLPOOL + AIRPOOL + CROMOTERAPIA + DISINFEZIONE
WHIRLPOOL + AIRPOOL + CHROMOTHERAPY + DISINFECTION
(PAG. 62)
Whirlpool jets: n. 6
Airpool jets: n. 12

	Cod.	Descrizione Description	Kg	Bianco White
DX Right	SHAIT17070D	Guscio e telaio Shell and frame	88	€ 2.200,00
SX Left	SHAIT17070S	Guscio e telaio Shell and frame	88	€ 2.200,00

Motore Whirlpool / Whirlpool Pump: 1 Cv / 1 Hp
Motore Airpool / Airpool Pump: 650 Watt / Volts 220/230, 50-60 Hz
Sonda di livello / Level probe

ACCESSORI ACCESORIES



Cod.	Descrizione Description	Bianco White
PROFBV	Profilo bordo vasca Bath tub rim finish	€ 70,00
SHAPOG03	Poggiatesta Sharm RETTANGOLARE Head rest	€ 40,00

SHARM RETTANGOLARE Design Alessandro Paoletti

1800X800X h 600 mm (260 lt)

SX - Left



DX - Right



PANNELLI SKIRTS

DX - Right



Cod.	Descrizione Description	Bianco White
SHAPAN180	Pannello Sharm 1800 mm Skirt	€ 245,00
SHAPANA80	Pannello Sharm 800 mm Skirt	€ 160,00

**! SPECIFICARE SEMPRE LA COMPOSIZIONE DEI PANNELLI ALL'ORDINE
ALWAYS SPECIFY THE PANELS COMPOSITION WHEN PLACING THE ORDER**

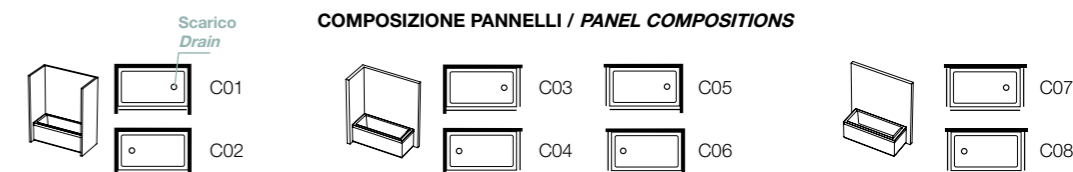

versione **SENZA IDROMASSAGGIO**
version **WITHOUT WHIRLPOOL**

	Cod.	Descrizione Description	Kg	Bianco White
	SHAG18080	Guscio Shell	25	€ 445,00
	SHAGT18080	Guscio e telaio Shell and frame	66	€ 725,00

RUBINETTERIE TAPS



Cod.	Descrizione Description	Cromo Chrome
RUB4F	Rubinetteria 4 fori Tap 4 holes	€ 620,00
RUB3F	Rubinetteria 3 fori Tap 3 holes	€ 495,00
COLSCERO	Colonna di scarico con erogatore Drain pipe with bath filler	€ 120,00
COLSCA	Colonna di scarico Drain pipe	€ 60,00

NB: Le versioni con IDROMASSAGGIO comprendono sempre la colonna di scarico (cod. COLSCA).
NOTE: The HYDRO-MASSAGE versions are always with drain pipe included (cod. COLSCA).

versione **SISTEMA IDRO+**
IDRO+ SISTEM version



WHIRLPOOL + CROMOTERAPIA
WHIRLPOOL + CHROMOTHERAPY
(PAG. 62)
Whirlpool jets: n. 8

	Cod.	Descrizione Description	Kg	Bianco White
DX Right	SHAI18080D	Guscio e telaio Shell and frame	80	€ 1.725,00
SX Left	SHAI18080S	Guscio e telaio Shell and frame	80	€ 1.725,00

Motore Whirlpool / Whirlpool Pump: 1 Cv / 1 Hp
Sonda di livello / Level probe

ACCESSORI ACCESSORIES

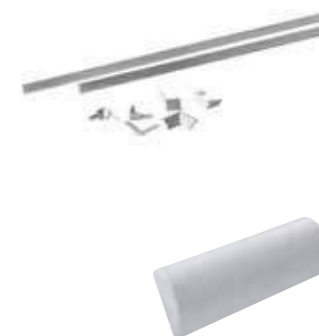

Cod.	Descrizione Description	Bianco White
PROFBV	Profilo bordo vasca Bath tub rim finish	€ 70,00
SHAPOG03	Poggiatesta Sharm RETTANGOLARE Head rest	€ 40,00

versione **SISTEMA IDRO-TECNO**
IDRO-TECNO SISTEM version



WHIRLPOOL + AIRPOOL + CROMOTERAPIA + DISINFEZIONE
WHIRLPOOL + AIRPOOL + CHROMOTHERAPY + DISINFECTION
(PAG. 62)
Whirlpool jets: n. 8
Airpool jets: n. 12



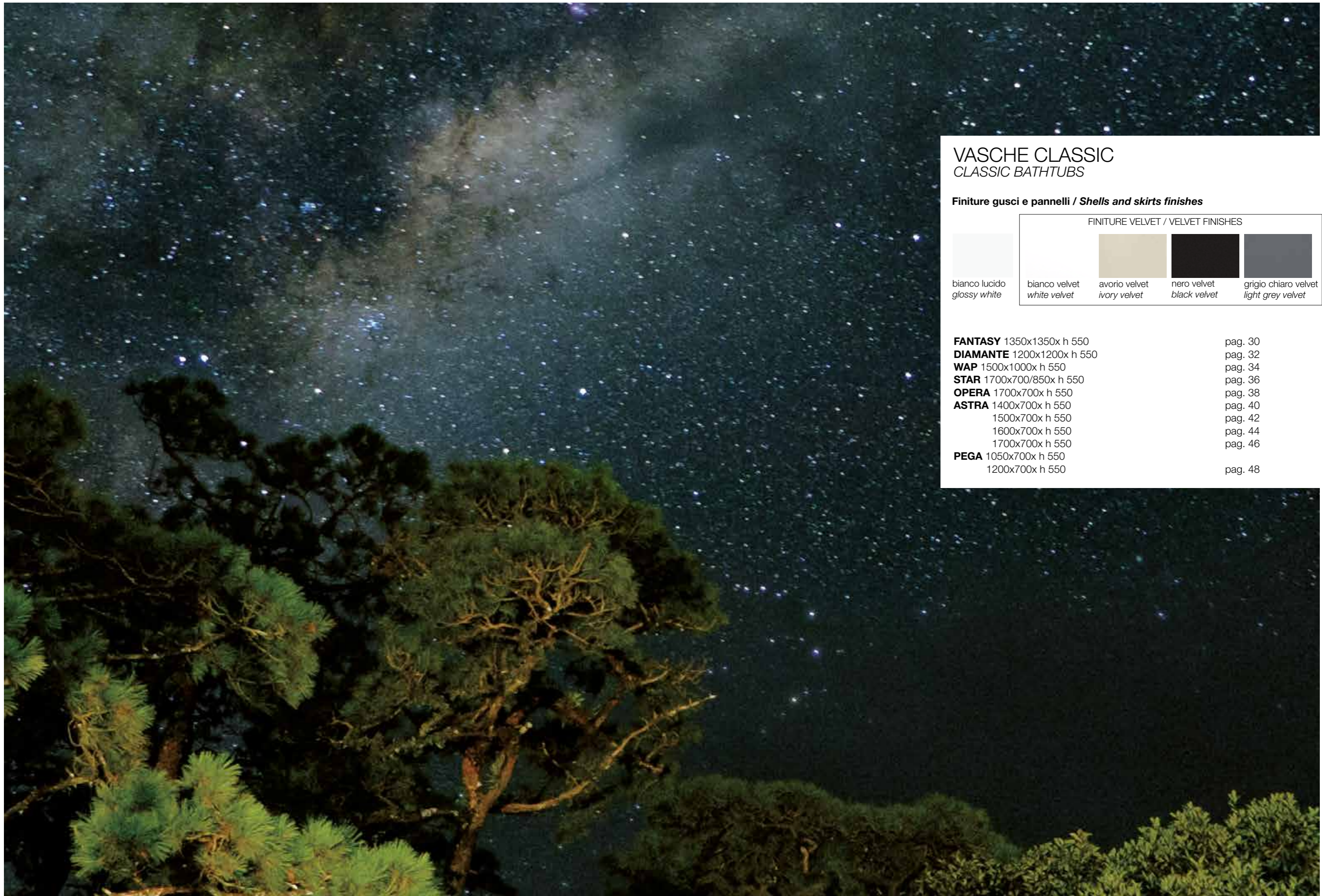

	Cod.	Descrizione Description	Kg	Bianco White
DX Right	SHAIT18080D	Guscio e telaio Shell and frame	99	€ 2.300,00
SX Left	SHAIT18080S	Guscio e telaio Shell and frame	99	€ 2.300,00

Motore Whirlpool / Whirlpool Pump: 1 Cv / 1 Hp
Motore Airpool / Airpool Pump: 650 Watt / Volts 220/230, 50-60 Hz
Sonda di livello / Level probe

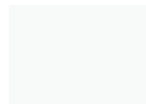

VASCHE CLASSIC CLASSIC BATHTUBS

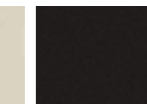
Finiture gusci e pannelli / Shells and skirts finishes

FINITURE VELVET / VELVET FINISHES				
				
bianco lucido <i>glossy white</i>	bianco velvet <i>white velvet</i>	avorio velvet <i>ivory velvet</i>	nero velvet <i>black velvet</i>	grigio chiaro velvet <i>light grey velvet</i>

FANTASY 1350x1350x h 550	pag. 30
DIAMANTE 1200x1200x h 550	pag. 32
WAP 1500x1000x h 550	pag. 34
STAR 1700x700/850x h 550	pag. 36
OPERA 1700x700x h 550	pag. 38
ASTRA 1400x700x h 550	pag. 40
1500x700x h 550	pag. 42
1600x700x h 550	pag. 44
1700x700x h 550	pag. 46
PEGA 1050x700x h 550	
1200x700x h 550	pag. 48

FANTASY

1350X1350X h 550 mm (250 lt)

Finiture Gusci e Pannelli / Shells and Skirts finishes

FINITURE VELVET / VELVET FINISHES



bianco lucido
glossy white
Cod. **B**



bianco velvet
white velvet
Cod. **BV**



avorio velvet
ivory velvet
Cod. **AV**





nero velvet
black velvet
Cod. **NE**



grigio chiaro velvet
light grey velvet
Cod. **GC**

Specificare sempre la finitura all'ordine.
Always specify the finish when placing the order.

versione **SENZA IDROMASSAGGIO**
version **WITHOUT WHIRLPOOL**

	Cod.	Descrizione Description	Kg	Bianco White	Finiture Velvet Velvet Finishes
	FANTG	Guscio Shell	18	€ 280,00	€ 420,00
	FANTGT	Guscio e telaio Shell and frame	52	€ 520,00	€ 660,00

versione **SISTEMA IDRO+**
IDRO+ SISTEM version



WHIRLPOOL + CROMOTERAPIA
WHIRLPOOL + CHROMOTHERAPY
(PAG. 62)
Whirlpool jets: n. 7

	Cod.	Descrizione Description	Kg	Bianco White	Finiture Velvet Velvet Finishes
	FANTI	Guscio e telaio Shell and frame	64	€ 1.520,00	€ 1.660,00

Motore Whirlpool / Whirlpool Pump: 1 Cv / 1 Hp
Sonda di livello / Level probe

versione **SISTEMA IDRO-TECNO**
IDRO-TECNO SISTEM version



WHIRLPOOL + AIRPOOL +
CROMOTERAPIA + DISINFEZIONE
WHIRLPOOL + AIRPOOL +
CHROMOTHERAPY + DISINFECTION
(PAG. 62)
Whirlpool jets: n. 7
Airpool jets: n. 16

	Cod.	Descrizione Description	Kg	Bianco White	Finiture Velvet Velvet Finishes
	FANTIT	Guscio e telaio Shell and frame	83	€ 2.100,00	€ 2.240,00

Motore Whirlpool / Whirlpool Pump: 1 Cv / 1 Hp
Motore Airpool / Airpool Pump: 650 Watt / Volts 220/230, 50-60 Hz
Sonda di livello / Level probe

PANNELLI SKIRTS



Cod.	Descrizione Description	Bianco White	Finiture Velvet Velvet Finishes
FANTPAN	Pannello FANTASY Skirt	€ 265,00	€ 390,00

Specificare sempre la finitura all'ordine.
Always specify the finish when placing the order.

RUBINETTERIE TAPS



Cod.	Descrizione Description	Cromo Chrome
RUB4F	Rubinetteria 4 fori Tap 4 holes	€ 620,00
RUB3F	Rubinetteria 3 fori Tap 3 holes	€ 495,00
COLSCERO	Colonna di scarico con erogatore Drain pipe with bath filler	€ 120,00
COLSCA	Colonna di scarico Drain pipe	€ 60,00

NB: Le versioni con IDROMASSAGGIO comprendono sempre la colonna di scarico (cod. COLSCA).
NOTE: The HYDRO-MASSAGE versions are always with drain pipe included (cod. COLSCA).

ACCESSORI ACCESORIES



Cod.	Descrizione Description	Bianco White
PROFBV	Profilo bordo vasca Bath tub rim finish	€ 70,00
FANTSED	Sedile FANTASY Seat	€ 135,00

DIAMANTE

1200X1200X h 550 mm (160 lt)

Finiture Gusci e Pannelli / Shells and Skirts finishes

FINITURE VELVET / VELVET FINISHES



bianco lucido
glossy white
Cod. **B**

bianco velvet
white velvet
Cod. **BV**

avorio velvet
ivory velvet
Cod. **AV**

nero velvet
black velvet
Cod. **NE**

grigio chiaro velvet
light grey velvet
Cod. **GC**

Specificare sempre la finitura all'ordine.
Always specify the finish when placing the order.

versione **SENZA IDROMASSAGGIO**
version **WITHOUT WHIRLPOOL**

	Cod.	Descrizione Description	Kg	Bianco White	Finiture Velvet Velvet Finishes
	DIAMG	Guscio Shell	18	€ 280,00	€ 420,00
	DIAMGT	Guscio e telaio Shell and frame	48	€ 490,00	€ 630,00

versione **SISTEMA IDRO+**
IDRO+ SISTEM version



WHIRLPOOL + CROMOTERAPIA
WHIRLPOOL + CHROMOTHERAPY
(PAG. 62)
Whirlpool jets: n. 5

	Cod.	Descrizione Description	Kg	Bianco White	Finiture Velvet Velvet Finishes
	DIAMI	Guscio e telaio Shell and frame	60	€ 1.490,00	€ 1.630,00

Motore Whirlpool / Whirlpool Pump: 1 Cv / 1 Hp
Sonda di livello / Level probe

versione **SISTEMA IDRO-TECNO**
IDRO-TECNO SISTEM version



WHIRLPOOL + AIRPOOL +
CROMOTERAPIA + DISINFEZIONE
WHIRLPOOL + AIRPOOL +
CHROMOTHERAPY + DISINFECTION
(PAG. 62)
Whirlpool jets: n. 5
Airpool jets: n. 12

	Cod.	Descrizione Description	Kg	Bianco White	Finiture Velvet Velvet Finishes
	DIAMIT	Guscio e telaio Shell and frame	79	€ 2.070,00	€ 2.210,00

Motore Whirlpool / Whirlpool Pump: 1 Cv / 1 Hp
Motore Airpool / Airpool Pump: 650 Watt / Volts 220/230, 50-60 Hz
Sonda di livello / Level probe

PANNELLI PANNELLI / SKIRTS



Cod.	Descrizione Description	Bianco White	Finiture Velvet Velvet Finishes
DIAMPAN	Pannello DIAMANTE Skirt	€ 245,00	€ 365,00

Specificare sempre la finitura all'ordine.
Always specify the finish when placing the order.

RUBINETTERIE TAPS



Cod.	Descrizione Description	Cromo Chrome
RUB4F	Rubinetteria 4 fori Tap 4 holes	€ 620,00
RUB3F	Rubinetteria 3 fori Tap 3 holes	€ 495,00
COLSCERO	Colonna di scarico con erogatore Drain pipe with bath filler	€ 120,00
COLSCA	Colonna di scarico Drain pipe	€ 60,00

NB: Le versioni con IDROMASSAGGIO comprendono sempre la colonna di scarico (cod. COLSCA).
NOTE: The HYDRO-MASSAGE versions are always with drain pipe included (cod. COLSCA).

ACCESSORI ACCESORIES



Cod.	Descrizione Description	Bianco White
PROFBV	Profilo bordo vasca Bath tub rim finish	€ 70,00

WAP

1500X1000X h 550 mm (110 lt)

Finiture Gusci e Pannelli / Shells and Skirts finishes



Specificare sempre la finitura all'ordine.
Always specify the finish when placing the order.

versione **SENZA IDROMASSAGGIO**
version **WITHOUT WHIRLPOOL**

	Cod.	Descrizione Description	Kg	Bianco White	Finiture Velvet Velvet Finishes
DX Right	WAPGD	Guscio Shell	18	€ 270,00	€ 400,00
SX Left	WAPGS	Guscio Shell	18	€ 270,00	€ 400,00
DX Right	WAPGTD	Guscio e telaio Shell and frame	46	€ 490,00	€ 620,00
SX Left	WAPGTS	Guscio e telaio Shell and frame	46	€ 490,00	€ 620,00

versione **SISTEMA IDRO+**
IDRO+ SISTEM version

WHIRLPOOL + CROMOTERAPIA
WHIRLPOOL + CHROMOTHERAPY
(PAG. 62)
Whirlpool jets: n. 6

	Cod.	Descrizione Description	Kg	Bianco White	Finiture Velvet Velvet Finishes
DX Right	WAPID	Guscio e telaio Shell and frame	58	€ 1.490,00	€ 1.620,00
SX Left	WAPIS	Guscio e telaio Shell and frame	58	€ 1.490,00	€ 1.620,00

Motore Whirlpool / Whirlpool Pump: 1 Cv / 1 Hp
Sonda di livello / Level probe

versione **SISTEMA IDRO-TECNO**
IDRO-TECNO SISTEM version

WHIRLPOOL + AIRPOOL +
CROMOTERAPIA + DISINFEZIONE
WHIRLPOOL + AIRPOOL +
CHROMOTHERAPY + DISINFECTION
(PAG. 62)
Whirlpool jets: n. 6
Airpool jets: n. 12

	Cod.	Descrizione Description	Kg	Bianco White	Finiture Velvet Velvet Finishes
DX Right	WAPITD	Guscio e telaio Shell and frame	77	€ 2.070,00	€ 2.200,00
SX Left	WAPITS	Guscio e telaio Shell and frame	77	€ 2.070,00	€ 2.200,00

Motore Whirlpool / Whirlpool Pump: 1 Cv / 1 Hp
Motore Airpool / Airpool Pump: 650 Watt / Volts 220/230, 50-60 Hz
Sonda di livello / Level probe

PANNELLI SKIRTS



	Cod.	Descrizione Description	Bianco White	Finiture Velvet Velvet Finishes
DX Right	WAPPAND	Pannello Skirt	€ 210,00	€ 310,00
SX Left	WAPPANS	Pannello Skirt	€ 210,00	€ 310,00

Specificare sempre la finitura all'ordine.
Always specify the finish when placing the order.

SOPRAVASCA DOOR BATHTUB SCREEN



	Cod.	Descrizione Description	Bianco White
	SV5082010	Soprasasca Bathtub screen	€ 540,00

RUBINETTERIE TAPS



	Cod.	Descrizione Description	Cromo Chrome
	RUB4F	Rubinetteria 4 fori Tap 4 holes	€ 620,00
	RUB3F	Rubinetteria 3 fori Tap 3 holes	€ 495,00
	COLSCERO	Colonna di scarico con erogatore Drain pipe with bath filler	€ 120,00
	COLSCA	Colonna di scarico Drain pipe	€ 60,00

NB: Le versioni con IDROMASSAGGIO comprendono sempre la colonna di scarico (cod. COLSCA).
NOTE: The HYDRO-MASSAGE versions are always with drain pipe included (cod. COLSCA).

ACCESSORI ACCESORIES



	Cod.	Descrizione Description	Bianco White
	PROFBV	Profilo bordo vasca Bath tub rim finish	€ 70,00
DX Right	WAPSEDD	Sedile WAP Seat	€ 144,00
SX Left	WAPSEDS	Sedile WAP Seat	€ 144,00

STAR

1700X700/850X h 550 mm (130 lt)

Finiture Gusci e Pannelli / Shells and Skirts finishes

FINITURE VELVET / VELVET FINISHES



bianco lucido
glossy white
Cod. **B**

bianco velvet
white velvet
Cod. **BV**

avorio velvet
ivory velvet
Cod. **AV**

nero velvet
black velvet
Cod. **NE**

grigio chiaro velvet
light grey velvet
Cod. **GC**

**Specificare sempre la finitura all'ordine.
Always specify the finish when placing the order.**

versione **SENZA IDROMASSAGGIO**
version **WITHOUT WHIRLPOOL**

	Cod.	Descrizione Description	Kg	Bianco White	Finiture Velvet Velvet Finishes
DX Right	STARGD	Guscio Shell	16	€ 280,00	€ 410,00
SX Left	STARGS	Guscio Shell	16	€ 280,00	€ 410,00
DX Right	STARGTD	Guscio e telaio Shell and frame	51	€ 470,00	€ 600,00
SX Left	STARGTS	Guscio e telaio Shell and frame	51	€ 470,00	€ 600,00

versione **SISTEMA IDRO+**
IDRO+ **SISTEM** version

	Cod.	Descrizione Description	Kg	Bianco White	Finiture Velvet Velvet Finishes
DX Right	STARID	Guscio e telaio Shell and frame	63	€ 1.470,00	€ 1.600,00
SX Left	STARIS	Guscio e telaio Shell and frame	63	€ 1.470,00	€ 1.600,00

Motore Whirlpool / Whirlpool Pump: 1 Cv / 1 Hp
Sonda di livello / Level probe

versione **SISTEMA IDRO-TECNO**
IDRO-TECNO **SISTEM** version

	Cod.	Descrizione Description	Kg	Bianco White	Finiture Velvet Velvet Finishes
DX Right	STARITD	Guscio e telaio Shell and frame	82	€ 2.050,00	€ 2.180,00
SX Left	STARITS	Guscio e telaio Shell and frame	82	€ 2.050,00	€ 2.180,00

Motore Whirlpool / Whirlpool Pump: 1 Cv / 1 Hp
Motore Airpool / Airpool Pump: 650 Watt / Volts 220/230, 50-60 Hz
Sonda di livello / Level probe

PANNELLI SKIRTS



	Cod.	Descrizione Description	Bianco White	Finiture Velvet Velvet Finishes
DX Right	STARPAN170D	Pannello STAR 1700 mm Skirt	€ 230,00	€ 340,00
SX Left	STARPAN170S	Pannello STAR 1700 mm Skirt	€ 230,00	€ 340,00
	CLASPAN70	Pannello Classic 700 mm Skirt	€ 140,00	€ 210,00

**! SPECIFICARE SEMPRE LA COMPOSIZIONE DEI PANNELLI ALL'ORDINE
ALWAYS SPECIFY THE PANELS COMPOSITION WHEN PLACING THE ORDER**

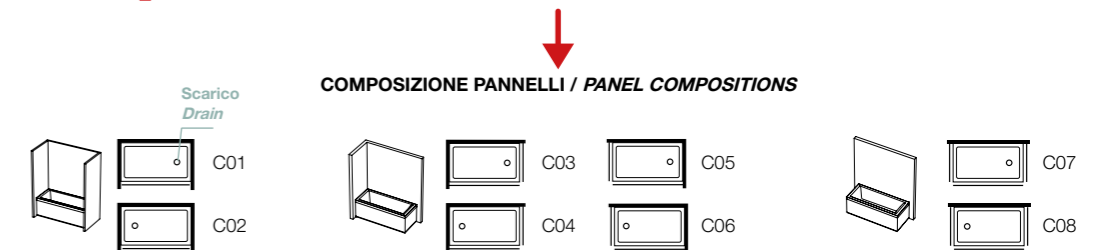

RUBINETTERIE TAPS



Cod.	Descrizione Description	Cromo Chrome
RUB4F	Rubinetteria 4 fori Tap 4 holes	€ 620,00
RUB3F	Rubinetteria 3 fori Tap 3 holes	€ 495,00
COLSCERO	Colonna di scarico con erogatore Drain pipe with bath filler	€ 120,00
COLSCA	Colonna di scarico Drain pipe	€ 60,00

NB: Le versioni con IDROMASSAGGIO comprendono sempre la colonna di scarico (cod. COLSCA).
NOTE: The HYDRO-MASSAGE versions are always with drain pipe included (cod. COLSCA).

ACCESSORI ACCESORIES



Cod.	Descrizione Description	Bianco White
PROFBV	Profilo bordo vasca Bath tub rim finish	€ 70,00
STARSED	Sedile STAR Seat	€ 144,00

OPERA

1700X700X h 550 mm (160 lt)

Finiture Gusci e Pannelli / Shells and Skirts finishes

FINITURE VELVET / VELVET FINISHES



Specificare sempre la finitura all'ordine.
Always specify the finish when placing the order.

versione **SENZA IDROMASSAGGIO**
version **WITHOUT WHIRLPOOL**

	Cod.	Descrizione Description	Kg	Bianco White	Finiture Velvet Velvet Finishes
	OPERAG	Guscio Shell	16	€ 240,00	€ 355,00
	OPERAGT	Guscio e telaio Shell and frame	54	€ 400,00	€ 515,00

versione **SISTEMA IDRO+**
IDRO+ SISTEM version



WHIRLPOOL + CROMOTERAPIA
WHIRLPOOL + CHROMOTHERAPY
(PAG. 62)
Whirlpool jets: n. 6

	Cod.	Descrizione Description	Kg	Bianco White	Finiture Velvet Velvet Finishes
DX Right	OPERAID	Guscio e telaio Shell and frame	69	€ 1.400,00	€ 1.515,00
SX Left	OPERAIS	Guscio e telaio Shell and frame	69	€ 1.400,00	€ 1.515,00

Motore Whirlpool / Whirlpool Pump: 1 Cv / 1 Hp
Sonda di livello / Level probe

versione **SISTEMA IDRO-TECNO**
IDRO-TECNO SISTEM version



WHIRLPOOL + AIRPOOL +
CROMOTERAPIA + DISINFEZIONE
WHIRLPOOL + AIRPOOL +
CHROMOTHERAPY + DISINFECTION
(PAG. 62)
Whirlpool jets: n. 6
Airpool jets: n. 12

	Cod.	Descrizione Description	Kg	Bianco White	Finiture Velvet Velvet Finishes
DX Right	OPERAITD	Guscio e telaio Shell and frame	88	€ 1.980,00	€ 2.095,00
SX Left	OPERAITS	Guscio e telaio Shell and frame	88	€ 1.980,00	€ 2.095,00

Motore Whirlpool / Whirlpool Pump: 1 Cv / 1 Hp
Motore Airpool / Airpool Pump: 650 Watt / Volts 220/230, 50-60 Hz
Sonda di livello / Level probe

PANNELLI SKIRTS



Cod.	Descrizione Description	Bianco White	Finiture Velvet Velvet Finishes
CLASSPAN170	Pannello Classic 1700 mm Skirt	€ 230,00	€ 340,00
CLASSPAN70	Pannello Classic 700 mm Skirt	€ 140,00	€ 210,00

! SPECIFICARE SEMPRE LA COMPOSIZIONE DEI PANNELLI ALL'ORDINE
ALWAYS SPECIFY THE PANELS COMPOSITION WHEN PLACING THE ORDER



COMPOSIZIONE PANNELLI / PANEL COMPOSITIONS

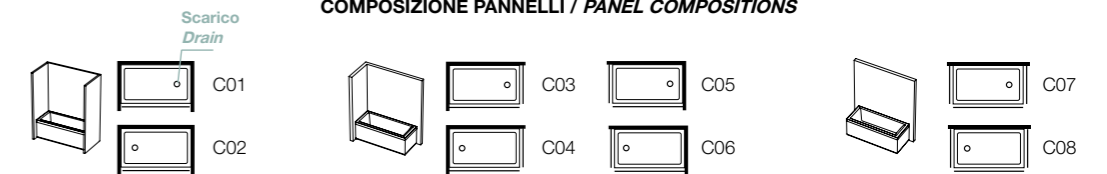

RUBINETTERIE TAPS



Cod.	Descrizione Description	Cromo Chrome
RUB4F	Rubinetteria 4 fori Tap 4 holes	€ 620,00
RUB3F	Rubinetteria 3 fori Tap 3 holes	€ 495,00
COLSCERO	Colonna di scarico con erogatore Drain pipe with bath filler	€ 120,00
COLSCA	Colonna di scarico Drain pipe	€ 60,00

NB: Le versioni con IDROMASSAGGIO comprendono sempre la colonna di scarico (cod. COLSCA).
NOTE: The HYDRO-MASSAGE versions are always with drain pipe included (cod. COLSCA).

ACCESSORI ACCESORIES



Cod.	Descrizione Description	Bianco White
PROFBV	Profilo bordo vasca Bath tub rim finish	€ 70,00

ASTRA

1400X700X h 550 mm (110 lt)

Finiture Gusci e Pannelli / Shells and Skirts finishes

FINITURE VELVET / VELVET FINISHES



DX - Right
SX - Left

bianco lucido glossy white Cod. **B**
bianco velvet white velvet Cod. **BV**
avorio velvet ivory velvet Cod. **AV**
nero velvet black velvet Cod. **NE**
grigio chiaro velvet light grey velvet Cod. **GC**

Specificare sempre la finitura all'ordine.
Always specify the finish when placing the order.

versione **SENZA IDROMASSAGGIO**
version **WITHOUT WHIRLPOOL**

	Cod.	Descrizione Description	Kg	Bianco White	Finiture Velvet Velvet Finishes
	ASTRAG140	Guscio Shell	13	€ 196,00	€ 292,00
	ASTRAGT140	Guscio e telaio Shell and frame	46	€ 350,00	€ 446,00

versione **SISTEMA IDRO+**
IDRO+ SISTEM version



WHIRLPOOL + CROMOTERAPIA
WHIRLPOOL + CHROMOTHERAPY
(PAG. 62)
Whirlpool jets: n. 6

	Cod.	Descrizione Description	Kg	Bianco White	Finiture Velvet Velvet Finishes
DX Right	ASTRAI140D	Guscio e telaio Shell and frame	58	€ 1.350,00	€ 1.460,00
SX Left	ASTRAI140S	Guscio e telaio Shell and frame	58	€ 1.350,00	€ 1.460,00

Motore Whirlpool / Whirlpool Pump: 1 Cv / 1 Hp
Sonda di livello / Level probe

versione **SISTEMA IDRO-TECNO**
IDRO-TECNO SISTEM version



WHIRLPOOL + AIRPOOL + CROMOTERAPIA + DISINFEZIONE
WHIRLPOOL + AIRPOOL + CHROMOTHERAPY + DISINFECTION
(PAG. 62)
Whirlpool jets: n. 6
Airpool jets: n. 12

	Cod.	Descrizione Description	Kg	Bianco White	Finiture Velvet Velvet Finishes
DX Right	ASTRAT140D	Guscio e telaio Shell and frame	77	€ 1.925,00	€ 2.070,00
SX Left	ASTRAT140S	Guscio e telaio Shell and frame	77	€ 1.925,00	€ 2.070,00

Motore Whirlpool / Whirlpool Pump: 1 Cv / 1 Hp
Motore Airpool / Airpool Pump: 650 Watt / Volts 220/230, 50-60 Hz
Sonda di livello / Level probe

PANNELLI SKIRTS



DX - Right

Cod.	Descrizione Description	Bianco White	Finiture Velvet Velvet Finishes
CLASSPAN140	Pannello Classic 1400 mm Skirt	€ 210,00	€ 310,00
CLASSPAN70	Pannello Classic 700 mm Skirt	€ 140,00	€ 210,00

! SPECIFICARE SEMPRE LA COMPOSIZIONE DEI PANNELLI ALL'ORDINE
ALWAYS SPECIFY THE PANELS COMPOSITION WHEN PLACING THE ORDER



COMPOSIZIONE PANNELLI / PANEL COMPOSITIONS

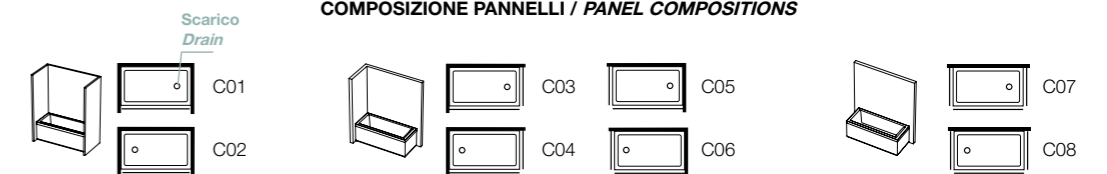

RUBINETTERIE TAPS



Cod.	Descrizione Description	Cromo Chrome
RUB4F	Rubinetteria 4 fori Tap 4 holes	€ 620,00
RUB3F	Rubinetteria 3 fori Tap 3 holes	€ 495,00
COLSCERO	Colonna di scarico con erogatore Drain pipe with bath filler	€ 120,00
COLSCA	Colonna di scarico Drain pipe	€ 60,00

NB: Le versioni con IDROMASSAGGIO comprendono sempre la colonna di scarico (cod. COLSCA).
NOTE: The HYDRO-MASSAGE versions are always with drain pipe included (cod. COLSCA).

ACCESSORI ACCESSORIES



Cod.	Descrizione Description	Bianco White
PROFBV	Profilo bordo vasca Bath tub rim finish	€ 70,00

ASTRA

1500X700X h 550 mm (120 lt)

Finiture Gusci e Pannelli / Shells and Skirts finishes

FINITURE VELVET / VELVET FINISHES



Specificare sempre la finitura all'ordine.
Always specify the finish when placing the order.

versione **SENZA IDROMASSAGGIO**
version **WITHOUT WHIRLPOOL**

	Cod.	Descrizione Description	Kg	Bianco White	Finiture Velvet Velvet Finishes
	ASTRAG150	Guscio Shell	14	€ 200,00	€ 297,00
	ASTRAGT150	Guscio e telaio Shell and frame	47	€ 375,00	€ 475,00

versione **SISTEMA IDRO+**
IDRO+ SISTEM version



WHIRLPOOL + CROMOTERAPIA
WHIRLPOOL + CHROMOTHERAPY
(PAG. 62)
Whirlpool jets: n. 6

	Cod.	Descrizione Description	Kg	Bianco White	Finiture Velvet Velvet Finishes
DX Right 	ASTRAI150D	Guscio e telaio Shell and frame	59	€ 1.375,00	€ 1.487,00
SX Left 	ASTRAI150S	Guscio e telaio Shell and frame	59	€ 1.375,00	€ 1.487,00

Motore Whirlpool / Whirlpool Pump: 1 Cv / 1 Hp
Sonda di livello / Level probe

versione **SISTEMA IDRO-TECNO**
IDRO-TECNO SISTEM version



WHIRLPOOL + AIRPOOL +
CROMOTERAPIA + DISINFEZIONE
WHIRLPOOL + AIRPOOL +
CHROMOTHERAPY + DISINFECTION
(PAG. 62)
Whirlpool jets: n. 6
Airpool jets: n. 12

	Cod.	Descrizione Description	Kg	Bianco White	Finiture Velvet Velvet Finishes
DX Right 	ASTRAT150D	Guscio e telaio Shell and frame	78	€ 1.950,00	€ 2.100,00
SX Left 	ASTRAT150S	Guscio e telaio Shell and frame	78	€ 1.950,00	€ 2.100,00

Motore Whirlpool / Whirlpool Pump: 1 Cv / 1 Hp
Motore Airpool / Airpool Pump: 650 Watt / Volts 220/230, 50-60 Hz
Sonda di livello / Level probe

PANNELLI SKIRTS



Cod.	Descrizione Description	Bianco White	Finiture Velvet Velvet Finishes
CLASSPAN150	Pannello Classic 1500 mm Skirt	€ 210,00	€ 310,00
CLASSPAN70	Pannello Classic 700 mm Skirt	€ 140,00	€ 210,00

! SPECIFICARE SEMPRE LA COMPOSIZIONE DEI PANNELLI ALL'ORDINE
ALWAYS SPECIFY THE PANELS COMPOSITION WHEN PLACING THE ORDER



COMPOSIZIONE PANNELLI / PANEL COMPOSITIONS

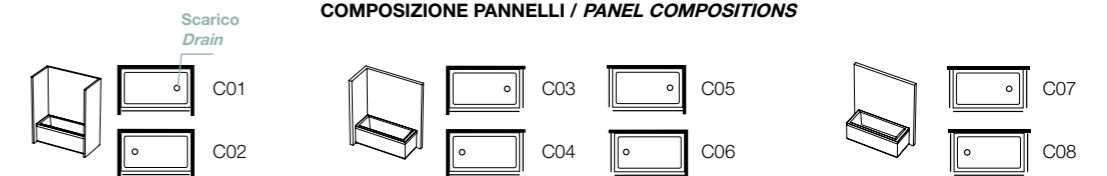

RUBINETTERIE TAPS



Cod.	Descrizione Description	Cromo Chrome
RUB4F	Rubinetteria 4 fori Tap 4 holes	€ 620,00
RUB3F	Rubinetteria 3 fori Tap 3 holes	€ 495,00
COLSCERO	Colonna di scarico con erogatore Drain pipe with bath filler	€ 120,00
COLSCA	Colonna di scarico Drain pipe	€ 60,00

NB: Le versioni con IDROMASSAGGIO comprendono sempre la colonna di scarico (cod. COLSCA).
NOTE: The HYDRO-MASSAGE versions are always with drain pipe included (cod. COLSCA).

ACCESSORI ACCESORIES



Cod.	Descrizione Description	Bianco White
PROFBV	Profilo bordo vasca Bath tub rim finish	€ 70,00

ASTRA

1600X700X h 550 mm (130 lt)

Finiture Gusci e Pannelli / Shells and Skirts finishes



Specificare sempre la finitura all'ordine.
Always specify the finish when placing the order.

versione **SENZA IDROMASSAGGIO**
version **WITHOUT WHIRLPOOL**

	Cod.	Descrizione Description	Kg	Bianco White	Finiture Velvet Velvet Finishes
	ASTRAG160	Guscio Shell	15	€ 214,00	€ 318,00
	ASTRAGT160	Guscio e telaio Shell and frame	49	€ 380,00	€ 484,00

versione **SISTEMA IDRO+**
IDRO+ SISTEM version

WHIRLPOOL + CROMOTERAPIA
WHIRLPOOL + CHROMOTHERAPY
(PAG. 62)
Whirlpool jets: n. 6

	Cod.	Descrizione Description	Kg	Bianco White	Finiture Velvet Velvet Finishes
DX Right	ASTRAI160D	Guscio e telaio Shell and frame	61	€ 1.380,00	€ 1.490,00
SX Left	ASTRAI160S	Guscio e telaio Shell and frame	61	€ 1.380,00	€ 1.490,00

Motore Whirlpool / Whirlpool Pump: 1 Cv / 1 Hp
Sonda di livello / Level probe

versione **SISTEMA IDRO-TECNO**
IDRO-TECNO SISTEM version

WHIRLPOOL + AIRPOOL +
CROMOTERAPIA + DISINFEZIONE
WHIRLPOOL + AIRPOOL +
CHROMOTHERAPY + DISINFECTION
(PAG. 62)
Whirlpool jets: n. 6
Airpool jets: n. 12

	Cod.	Descrizione Description	Kg	Bianco White	Finiture Velvet Velvet Finishes
DX Right	ASTRAT160D	Guscio e telaio Shell and frame	80	€ 1.960,00	€ 2.100,00
SX Left	ASTRAT160S	Guscio e telaio Shell and frame	80	€ 1.960,00	€ 2.100,00

Motore Whirlpool / Whirlpool Pump: 1 Cv / 1 Hp
Motore Airpool / Airpool Pump: 650 Watt / Volts 220/230, 50-60 Hz
Sonda di livello / Level probe

PANNELLI SKIRTS



Cod.	Descrizione Description	Bianco White	Finiture Velvet Velvet Finishes
CLASSPAN160	Pannello Classic 1600 mm Skirt	€ 220,00	€ 320,00
CLASSPAN70	Pannello Classic 700 mm Skirt	€ 140,00	€ 210,00

! SPECIFICARE SEMPRE LA COMPOSIZIONE DEI PANNELLI ALL'ORDINE
ALWAYS SPECIFY THE PANELS COMPOSITION WHEN PLACING THE ORDER



COMPOSIZIONE PANNELLI / PANEL COMPOSITIONS

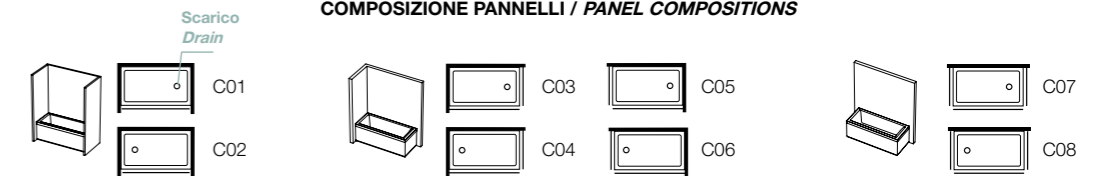

RUBINETTERIE TAPS



Cod.	Descrizione Description	Cromo Chrome
RUB4F	Rubinetteria 4 fori Tap 4 holes	€ 620,00
RUB3F	Rubinetteria 3 fori Tap 3 holes	€ 495,00
COLSCERO	Colonna di scarico con erogatore Drain pipe with bath filler	€ 120,00
COLSCA	Colonna di scarico Drain pipe	€ 60,00

NB: Le versioni con IDROMASSAGGIO comprendono sempre la colonna di scarico (cod. COLSCA).
NOTE: The HYDRO-MASSAGE versions are always with drain pipe included (cod. COLSCA).

ACCESSORI ACCESORIES



Cod.	Descrizione Description	Bianco White
PROFBV	Profilo bordo vasca Bath tub rim finish	€ 70,00

ASTRA

1700X700X h 550 mm (140 lt)

Finiture Gusci e Pannelli / Shells and Skirts finishes

FINITURE VELVET / VELVET FINISHES



**Specificare sempre la finitura all'ordine.
Always specify the finish when placing the order.**

versione **SENZA IDROMASSAGGIO**
version **WITHOUT WHIRLPOOL**

	Cod.	Descrizione Description	Kg	Bianco White	Finiture Velvet Velvet Finishes
	ASTRAG170	Guscio Shell	16	€ 240,00	€ 355,00
	ASTRAGT170	Guscio e telaio Shell and frame	50	€ 400,00	€ 515,00

versione **SISTEMA IDRO+**
IDRO+ SISTEM version

WHIRLPOOL + CROMOTERAPIA
WHIRLPOOL + CHROMOTHERAPY
(PAG. 62)
Whirlpool jets: n. 6

	Cod.	Descrizione Description	Kg	Bianco White	Finiture Velvet Velvet Finishes
DX Right	ASTRAI170D	Guscio e telaio Shell and frame	62	€ 1.400,00	€ 1.515,00
SX Left	ASTRAI170S	Guscio e telaio Shell and frame	62	€ 1.400,00	€ 1.515,00

Motore Whirlpool / Whirlpool Pump: 1 Cv / 1 Hp
Sonda di livello / Level probe

versione **SISTEMA IDRO-TECNO**
IDRO-TECNO SISTEM version

WHIRLPOOL + AIRPOOL +
CROMOTERAPIA + DISINFEZIONE
WHIRLPOOL + AIRPOOL +
CHROMOTHERAPY + DISINFECTION
(PAG. 62)
Whirlpool jets: n. 6
Airpool jets: n. 12

	Cod.	Descrizione Description	Kg	Bianco White	Finiture Velvet Velvet Finishes
DX Right	ASTRAT170D	Guscio e telaio Shell and frame	81	€ 1.980,00	€ 2.095,00
SX Left	ASTRAT170S	Guscio e telaio Shell and frame	81	€ 1.980,00	€ 2.095,00

Motore Whirlpool / Whirlpool Pump: 1 Cv / 1 Hp
Motore Airpool / Airpool Pump: 650 Watt / Volts 220/230, 50-60 Hz
Sonda di livello / Level probe

PANNELLI SKIRTS



Cod.	Descrizione Description	Bianco White	Finiture Velvet Velvet Finishes
CLASSPAN170	Pannello Classic 1700 mm Skirt	€ 230,00	€ 340,00
CLASSPAN70	Pannello Classic 700 mm Skirt	€ 140,00	€ 210,00

**! SPECIFICARE SEMPRE LA COMPOSIZIONE DEI PANNELLI ALL'ORDINE
ALWAYS SPECIFY THE PANELS COMPOSITION WHEN PLACING THE ORDER**



COMPOSIZIONE PANNELLI / PANEL COMPOSITIONS

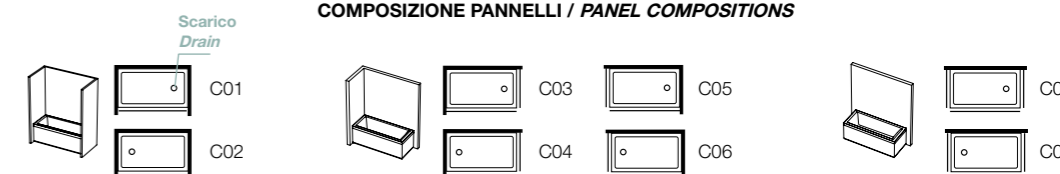

RUBINETTERIE TAPS



Cod.	Descrizione Description	Cromo Chrome
RUB4F	Rubinetteria 4 fori Tap 4 holes	€ 620,00
RUB3F	Rubinetteria 3 fori Tap 3 holes	€ 495,00
COLSCERO	Colonna di scarico con erogatore Drain pipe with bath filler	€ 120,00
COLSCA	Colonna di scarico Drain pipe	€ 60,00

NB: Le versioni con IDROMASSAGGIO comprendono sempre la colonna di scarico (cod. COLSCA).
NOTE: The HYDRO-MASSAGE versions are always with drain pipe included (cod. COLSCA).

ACCESSORI ACCESORIES



Cod.	Descrizione Description	Bianco White
PROFBV	Profilo bordo vasca Bath tub rim finish	€ 70,00

PEGA

1050X700X h 550 mm (85 lt)
1200X700X h 550 mm (100 lt)

Finiture Gusci e Pannelli / Shells and Skirts finishes

FINITURE VELVET / VELVET FINISHES



bianco lucido
glossy white
Cod. **B**

bianco velvet
white velvet
Cod. **BV**

avorio velvet
ivory velvet
Cod. **AV**

nero velvet
black velvet
Cod. **NE**

grigio chiaro velvet
light grey velvet
Cod. **GC**

Specificare sempre la finitura all'ordine.
Always specify the finish when placing the order.

versione **SENZA IDROMASSAGGIO**
version **WITHOUT WHIRLPOOL**

	Cod.	Descrizione Description	Kg	Bianco White	Finiture Velvet Velvet Finishes
1050X700 	PEGAG105	Guscio Shell	12	€ 151,00	€ 224,00
1050X700 	PEGAGT105	Guscio e telaio Shell and frame	24	€ 320,00	€ 400,00
1200X700 	PEGAG120	Guscio Shell	13	€ 179,00	€ 270,00
1200X700 	PEGAGT120	Guscio e telaio Shell and frame	25	€ 355,00	€ 447,00

PANNELLI SKIRTS



Cod.	Descrizione Description	Bianco White	Finiture Velvet Velvet Finishes
CLASSPAN105	Pannello Classic 1050 mm Skirt	€ 175,00	€ 260,00
CLASSPAN120	Pannello Classic 1200 mm Skirt	€ 175,00	€ 260,00
CLASSPAN70	Pannello Classic 700 mm Skirt	€ 140,00	€ 210,00

! SPECIFICARE SEMPRE LA COMPOSIZIONE DEI PANNELLI ALL'ORDINE
ALWAYS SPECIFY THE PANELS COMPOSITION WHEN PLACING THE ORDER

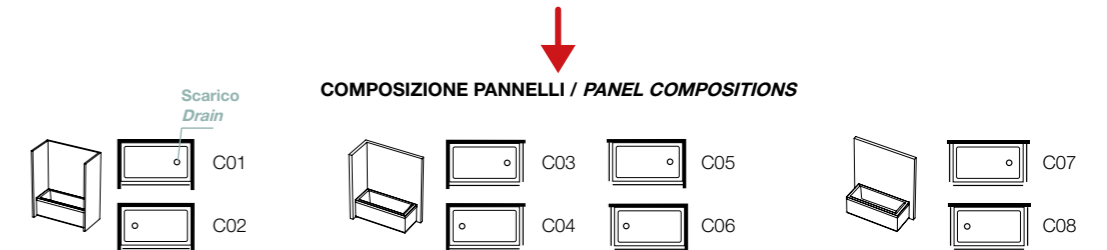

RUBINETTERIE TAPS



Cod.	Descrizione Description	Cromo Chrome
RUB4F	Rubinetteria 4 fori Tap 4 holes	€ 620,00
RUB3F	Rubinetteria 3 fori Tap 3 holes	€ 495,00
COLSCERO	Colonna di scarico con erogatore Drain pipe with bath filler	€ 120,00
COLSCA	Colonna di scarico Drain pipe	€ 60,00

NB: Le versioni con IDROMASSAGGIO comprendono sempre la colonna di scarico (cod. COLSCA).
NOTE: The HYDRO-MASSAGE versions are always with drain pipe included (cod. COLSCA).

ACCESSORI ACCESORIES



Cod.	Descrizione Description	Bianco White
PROFBV	Profilo bordo vasca Bath tub rim finish	€ 70,00



VASCHE FREE-STANDING FREE-STANDING BATHTUBS

POLYMINERAL (SOLID SURFACE)

ATMOSFERE

Design Arch. Romano Adolini

TONDA Ø 1200 / Ø 1400 x h 550

pag. 53

OVALE 1600x800x h 550

pag. 53

QUADRATA 1200x1200x h 550

pag. 53

RETTANGOLARE

1600x700x h 550 / 1800x800x h 550

pag. 53

ACRILICO

CUSTOM

ADOLINI+SIMONINI
MILAN . SÃO PAULO

SNUG 1800x820x h 610

pag. 54

VOGUE 1800x900x h 560

pag. 55

CAPRI 1700x820x h 580

pag. 56

VENEZIA 1670x820x h 650

pag. 56

ROMA 1700x800x h 580

pag. 56

FIRENZE 1600x700x h 550

pag. 56

ASTORIA 1700x770x h 700

pag. 57

Il Polymineral. Tra purezza e resistenza.

Polymineral. Between purity and strength.

ATMOSFERE

Design Arch. Romano Adolini

Il POLYMINERAL (SOLID SURFACE) è un materiale solido e resistente, ma allo stesso tempo estremamente duttile. Permette di ottenere giunzioni praticamente invisibili delle vasche e di essere utilizzato unitamente ai metalli e alle leghe metalliche più comuni, come quelle di alluminio. È igienico, piacevole al tatto e permette di realizzare progetti dal design elaborato. Inodore e insapore è biologicamente puro e idoneo al contatto con alimenti, tanto da essere considerato il più igienico tra i materiali da rivestimento. Per questo e per le sue caratteristiche di robustezza e durata viene già utilizzato nelle superfici di lavoro, in ambienti pubblici, banche, studi medici, aeroporti.

Ha superato con successo i più avanzati test di resistenza al calore per questo motivo il Polymineral è adatto alla realizzazione vasche. Resistente alla luce diretta del sole, il colore del Polymineral resta immutato nel tempo con la sua caratteristica di traslucenza.

POLYMINERAL (SOLID SURFACE) is a solid and strong material that is also ductile. During the production process it is possible to obtain almost invisible joints in the bathtubs and can also be coupled with the most common metal alloys; such as aluminum. It is hygienic, pleasant to the touch and permits to manufacture elaborately designed projects. Odorless, flavorless and biologically pure, Polymineral is even suitable for food storage. For the above reasons it is considered one of the most hygienic covering materials. The durability and robustness of Polimeral makes it an easy choice to be used for work surfaces in public environments such as banks, medical offices and airports.

Polymineral successfully passed the most advanced heat resistance tests before being employed for bathtub production. This solid surface product is also resistant to direct sunlight and the color and translucent properties remain unvaried over time.



Bruciatura sigaro
Cigar burn mark



Rimmel
Rimmel



Macchia di caffè
Coffee stains



Pulizia con carta abrasiva P600/P1000
Cleaning with abrasive paper P600 / P1000



Polymineral pulito
Cleaned Polymineral

Design Arch. Romano Adolini **ATMOSFERE**

External finish: Glossy
Internal finish: Matt
One-piece casting
Push-push waste and trap
Overflow drain built-in

Repair kit available for scratches and accidental chipping.

Esterno: finitura lucida
Interno: finitura opaca
Realizzata per collaggio in monoblocco
Piletta up-down e sifone
Troppopieno integrato nella vasca

Disponibile kit di riparazione per eventuali graffi o scheggiature accidentali.

QUADRATA / SQUARE



Cod.	Descrizione Description	Kg	esterno: bianco lucido interno: bianco opaco external: glossy white internal: matt white	nero opaco matt black
961212	1200X1200X h 550 mm (314 lt)	175	€ 4.250,00	€ 4.800,00

RETTANGOLARE / RECTANGULAR



Cod.	Descrizione Description	Kg	esterno: bianco lucido interno: bianco opaco external: glossy white internal: matt white	nero opaco matt black
961670	1600X700X h 550 mm (256 lt)	170	€ 4.144,00	€ 4.650,00
961880	1800X800X h 550 mm (284 lt)	185	€ 4.420,00	€ 4.950,00

TONDA / ROUND



Cod.	Descrizione Description	Kg	esterno: bianco lucido interno: bianco opaco external: glossy white internal: matt white	nero opaco matt black
961200	Ø1200 X h 550 mm (307 lt)	174	€ 4.250,00	€ 4.850,00
961414	Ø1400 X h 550 mm (420 lt)	204	€ 4.500,00	€ 5.050,00

OVALE / OVAL



Cod.	Descrizione Description	Kg	esterno: bianco lucido interno: bianco opaco external: glossy white internal: matt white	nero opaco matt black
961680	1600X800X h 550 mm (235 lt)	170	€ 4.090,00	€ 4.600,00

CUSTOM Design
ADOLINI+SIMONINI
MILAN . SÃO PAULO

Design
ADOLINI+SIMONINI
MILAN . SÃO PAULO **CUSTOM**

La vasca è realizzata in due gusci saldati. Questa nuova tecnica rende il prodotto monolitico come se fosse un unico pezzo sia al tatto che alla vista.

The bathtub is made with two perfectly joined shells. This new production process creates a monolithic product: as if it were one single piece, both visually and to the touch.

Finitura lucida
Piletta up-down bianca
Piedini di regolazione
Bordo di soli 25 mm

*Glossy finish
White push-push waste
Adjustable feet
Thin rim edge of only 25 mm*

Disponibile kit di riparazione per eventuali graffi o scheggiature accidentali.

Repair kit available for scratches and accidental chipping.

Disponibile kit di riparazione per eventuali graffi o scheggiature accidentali.

Repair kit available for scratches and accidental chipping.

The bathtub is made with two perfectly joined shells. This new production process creates a monolithic product: as if it were one single piece, both visually and to the touch.

La vasca è realizzata in due gusci saldati. Questa nuova tecnica rende il prodotto monolitico come se fosse un unico pezzo sia al tatto che alla vista.

*Glossy finish
White push-push waste
Adjustable feet
Thin rim edge of only 25 mm*

Finitura lucida
Piletta up-down bianca
Piedini di regolazione
Bordo di soli 25 mm

Troppopieno invisible nella vasca

Invisible overflow drain

Invisible overflow drain

Troppopieno invisible nella vasca

SNUG



Cod.	Descrizione Description	Kg	Bianco White
VFO1808261	1800X820X h 610 (285 lt)	65	€ 2.400,00

VOGUE

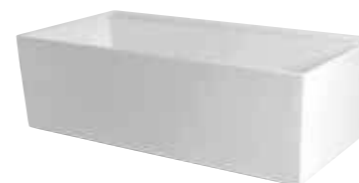

Cod.	Descrizione Description	Kg	Bianco White
VFR1809056	1800X900X h 560 (280 lt)	60	€ 2.800,00

OPTIONAL



Cod.	Descrizione Description	Finitura Finish	
SNGCUSN	Cuscino / Pillow	Nero / Black	€ 360,00



Cod.	Descrizione Description	Finitura Finish	
VGCUSN	Poggiatesta / Headrest SNUG	Nero / Black	€ 65,00

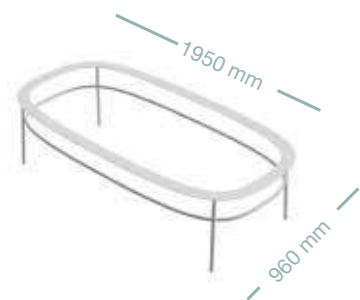

Cod.	Descrizione Description	Finitura Finish	
SNGPOB	Cornice multiuso / Multipurpose frame	Bianco / White	€ 1.410,00
SNGPON	Cornice multiuso / Multipurpose frame	Nero / Black	€ 1.410,00



Cod.	Descrizione Description	Finitura Finish	
VGPON	Mensola removibile / Removable headrest	Nero / Black	€ 78,00



Cod.	Descrizione Description	Finitura Finish	
VGBICB	Bicchieri per essenze / Essence container	Bianco / White	€ 45,00

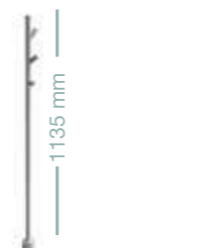

Cod.	Descrizione Description	Finitura Finish	
VGPAB	Portaccapatoio / Bathrobe holder	Bianco / White	€ 180,00
VGPAN	Portaccapatoio / Bathrobe holder	Nero / Black	€ 180,00

VASCHE FREE-STANDING IN ACRILICO
ACRYLIC FREE-STANDING BATH TUBS

La vasca è realizzata in due gusci saldati. Questa nuova tecnica rende il prodotto monolitico come se fosse un unico pezzo sia al tatto che alla vista.

The bathtub is made with two perfectly joined shells. This new production process creates a monolithic product: as if it were one single piece, both visually and to the touch.

Finitura lucida
Piletta up-down cromata
Troppopieno integrato nella vasca
Piedini di regolazione
Bordo di soli 25 mm

Glossy finish
Chrome push-push waste
Overflow drain built-in
Adjustable feet
Thin rim edge of only 25 mm

Disponibile kit di riparazione per eventuali graffi o scheggiature accidentali.

Repair kit available for scratches and accidental chipping.

CAPRI



Cod.	Descrizione Description	Kg	Bianco White
VFO1708258	1700X820X h 580 (276 lt)	58	€ 2.240,00

VENEZIA



Cod.	Descrizione Description	Kg	Bianco White
VFO1678265	1670X820X h 650 (236 lt)	60	€ 2.550,00

ROMA



Cod.	Descrizione Description	Kg	Bianco White
VFR1708058	1700X800X h 580 mm (281 lt)	73	€ 1.960,00

NB: Colonna di scarico con apertura/chiusura dal troppopieno.
NOTE: Drain column with opening/closing from the overflow.

FIRENZE



Cod.	Descrizione Description	Kg	Bianco White
VFR1607055	1600X7000X h 550 mm (226 lt)	51	€ 2.184,00

VASCHE FREE-STANDING IN ACRILICO
ACRYLIC FREE-STANDING BATH TUBS

Reinforced shell
Glossy finish
Brass feet

Guscio rinforzato
Finitura lucida
Piedi in ottone

Option: External overflow with plug chained to the overflow

Optional: colonna di scarico esterna con tappo dotato di catena al troppopieno



FINITURE / FINISHES

ASTORIA



Cod.	Descrizione Description	Finitura Finish	Kg
VASTWS	Guscio BIANCO / WHITE Shell 1700X700X h 700 mm (160lt)	Argento / Silver	99 € 1.170,00
VASTWW	Guscio BIANCO / WHITE Shell 1700X700X h 700 mm (160lt)	Bianco / White	99 € 1.240,00
VASTWG	Guscio BIANCO / WHITE Shell 1700X700X h 700 mm (160lt)	Oro / Gold	99 € 1.240,00
VASTWB	Guscio BIANCO / WHITE Shell 1700X700X h 700 mm (160lt)	Bronzo / Bronze	99 € 1.240,00



VASTBS	Guscio NERO / BLACK Shell 1700X700X h 700 mm (160lt)	Argento / Silver	99 € 1.200,00
VASTBW	Guscio NERO / BLACK Shell 1700X700X h 700 mm (160lt)	Bianco / White	99 € 1.280,00
VASTBG	Guscio NERO / BLACK Shell 1700X700X h 700 mm (160lt)	Oro / Gold	99 € 1.280,00
VASTBB	Guscio NERO / BLACK Shell 1700X700X h 700 mm (160lt)	Bronzo / Bronze	99 € 1.280,00

COLONNA DI SCARICO
DRAIN PIPE



Cod.	Descrizione Description	Finitura Finish
COLESTS	Colonna esterna / External column	Argento / Silver € 212,00
COLESTW	Colonna esterna / External column	Bianco / White € 356,00
COLESTG	Colonna esterna / External column	Oro / Gold € 356,00
COLESTB	Colonna esterna / External column	Bronzo / Bronze € 356,00

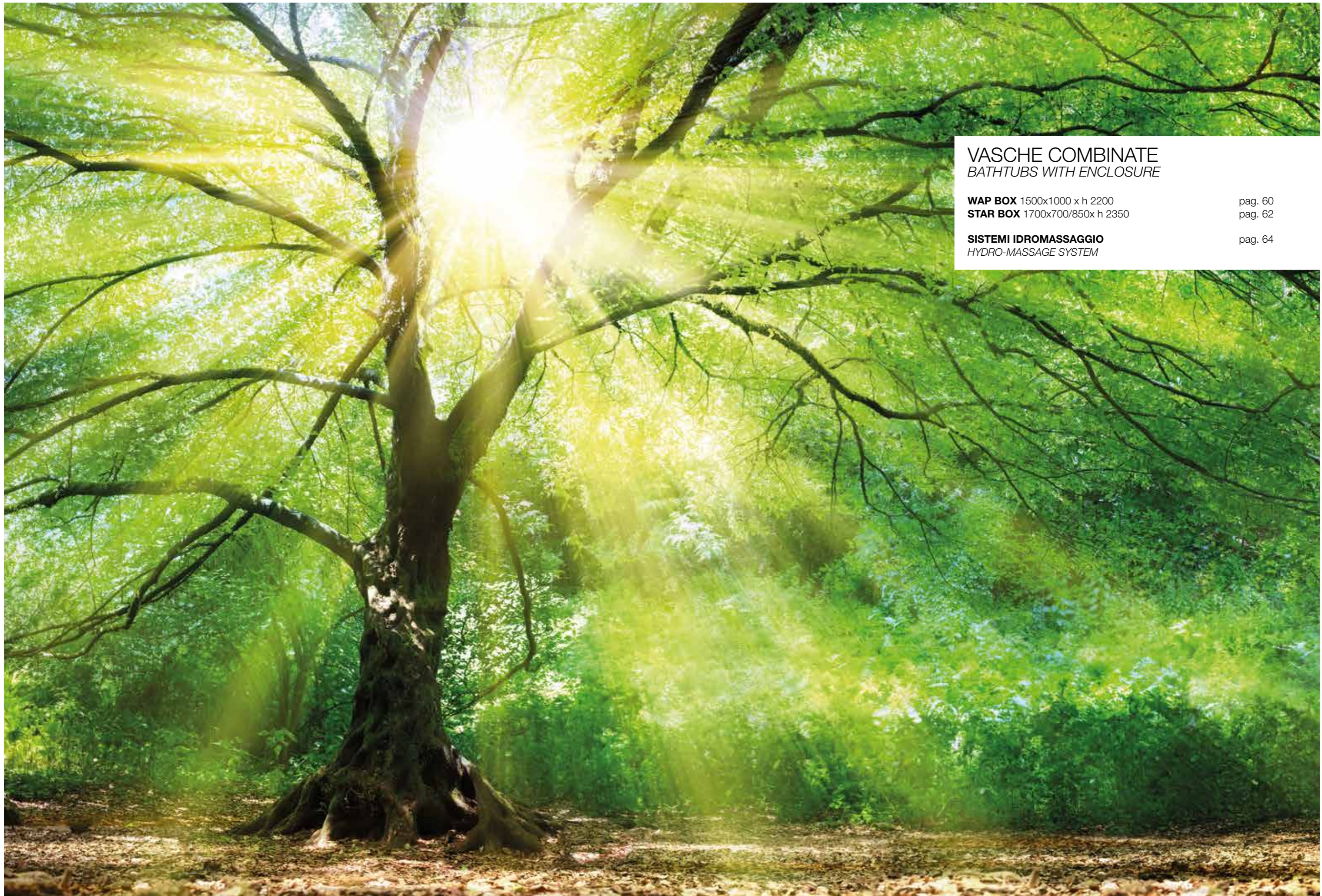

VASCHE COMBinate
BATHTUBS WITH ENCLOSURE

WAP BOX 1500x1000 x h 2200
STAR BOX 1700x700/850x h 2350

pag. 60
pag. 62

SISTEMI IDROMASSAGGIO
HYDRO-MASSAGE SYSTEM

pag. 64

WAP BOX

1500X1000X h 2100 mm (110 lt)



DOTAZIONI BOX / BOX EQUIPMENT

Cristallo temperato 6 mm
Finitura profili: bianca
Braccio di irrigidimento vetro cromo
Cerniere cromo
Seduta

6 mm tempered glass
White profiles
Chrome finish bracket
Chrome hinges
Seat

Finiture Gusci e Pannelli / Shells and Skirts Finishes

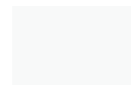

bianco lucido
glossy white

Cod. **B**

FINITURE VELVET / VELVET FINISHES



bianco velvet
white velvet

Cod. **BV**



avorio velvet
ivory velvet

Cod. **AV**



nero velvet
black velvet

Cod. **NE**



grigio chiaro velvet
light grey velvet

Cod. **GC**

Specificare sempre la finitura all'ordine.
Always specify the finish when placing the order.

versione **SENZA IDROMASSAGGIO**
version **WITHOUT WHIRLPOOL**

	Cod.	Descrizione Description	Kg	Bianco White	Finiture Velvet Velvet Finishes
DX Right	WAPBD	Vasca con pannello Bathtub with skirt	86	€ 1.240,00	€ 1.470,00
SX Left	WAPBS	Vasca con pannello Bathtub with skirt	86	€ 1.240,00	€ 1.470,00

versione **SISTEMA IDRO+**
IDRO+ SISTEM version

	Cod.	Descrizione Description	Kg	Bianco White	Finiture Velvet Velvet Finishes
DX Right	WAPBID	Vasca con pannello Bathtub with skirt	96	€ 2.240,00	€ 2.470,00
SX Left	WAPBIS	Vasca con pannello Bathtub with skirt	96	€ 2.240,00	€ 2.470,00

Motore Whirlpool / Whirlpool Pump: 1 Cv / 1 Hp
Sonda di livello / Level probe

versione **SISTEMA IDRO-TECNO**
IDRO-TECNO SISTEM version

	Cod.	Descrizione Description	Kg	Bianco White	Finiture Velvet Velvet Finishes
DX Right	WAPBITD	Vasca con pannello Bathtub with skirt	115	€ 2.820,00	€ 3.050,00
SX Left	WAPBITS	Vasca con pannello Bathtub with skirt	115	€ 2.820,00	€ 3.050,00

Motore Whirlpool / Whirlpool Pump: 1 Cv / 1 Hp
Motore Airpool / Airpool Pump: 650 Watt / Volts 220/230, 50-60 Hz
Sonda di livello / Level probe

COLONNA DOCCIA SHOWER COLUMN



Cod.	Descrizione Description	Cromo Chrome
CD700153SO	Bianca soffione ovale White oval shower head	€ 380,00
CD700152SQ	Bianca soffione quadrato White square shower head	€ 380,00

N.B. Approfondimenti colonne pag.140
NOTE: For more info about shower columns please check pag. 140

Finiture gusci e pannelli / Shell and skirt finishes

FINITURE VELVET / VELVET FINISHES

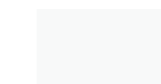

bianco lucido
glossy white



bianco velvet
white velvet



avorio velvet
ivory velvet



nero velvet
black velvet



grigio chiaro velvet
light grey velvet

RUBINETTERIE TAPS



Cod.	Descrizione Description	Cromo Chrome
RUB4F	Rubinetteria 4 fori Tap 4 holes	€ 620,00
RUB3F	Rubinetteria 3 fori Tap 3 holes	€ 495,00
COLSCERO	Colonna di scarico con erogatore Drain pipe with bath filler	€ 120,00
COLSCA	Colonna di scarico Drain pipe	€ 60,00

NB: Le versioni con IDROMASSAGGIO comprendono sempre la colonna di scarico (cod. COLSCA).
NOTE: The HYDRO-MASSAGE versions are always with drain pipe included (cod. COLSCA).

ACCESSORI ACCESSORIES



Cod.	Descrizione Description	Bianco White
PROFBV	Profilo bordo vasca Bath tub rim finish	€ 70,00
DX Right	WAPSEDD Sedile WAP Seat	€ 144,00
SX Left	WAPSEDS Sedile WAP Seat	€ 144,00

STAR BOX

1700X700/850X h 2350 mm (130 lt)



DOTAZIONI BOX

Cielo con carter di rifinitura
 Miscelatore meccanico
 Deviatore a 4 vie
 Soffione integrato ø 24 cm
 Bocca di riempimento vasca
 Asta saliscendi con doccino multifunzione
 Idrogetti orientabili: n.6
 Parete attrazzata in lastra unica e mensole integrate
 Chiusura scorrevole in cristallo temperato 6 mm
 Finitura profili: bianca
 Seduta

BOX EQUIPMENT

Roof with cover
 Mechanical tapware
 Four-way diverter
 Ø 24 cm overhead shower
 Bathtub fill spout
 Multi-function hand shower on sliding rail
 6 shower nozzles
 One-piece acrylic shower structure with integrated shelving
 6 mm tempered glass sliding shower enclosure
 White profiles
 Seat

versione **SENZA IDROMASSAGGIO**
 version **WITHOUT WHIRLPOOL**

	Cod.	Descrizione Description	Kg	Bianco White
DX Right	STARBD	Vasca con pannelli Bathtub with skirts	135	€ 2.170,00
SX Left	STARBS	Vasca con pannelli Bathtub with skirts	135	€ 2.170,00

Colonna di scarico inclusa / Drain pipe included

versione **SISTEMA IDRO+**
IDRO+ SISTEM version

	Cod.	Descrizione Description	Kg	Bianco White
DX Right	STARBD	Vasca con pannelli Bathtub with skirts	145	€ 3.180,00
SX Left	STARBS	Vasca con pannelli Bathtub with skirts	145	€ 3.180,00

Motore Whirlpool / Whirlpool Pump: 1 Cv / 1 Hp
 Sonda di livello / Level probe
 Colonna di scarico inclusa / Drain pipe included



WHIRLPOOL + CROMOTERAPIA
 WHIRLPOOL + CHROMOTHERAPY
 (PAG. 62)
 Whirlpool jets: n. 7

versione **SISTEMA IDRO-TECNO**
IDRO-TECNO SISTEM version

	Cod.	Descrizione Description	Kg	Bianco White
DX Right	STARBITD	Vasca con pannelli Bathtub with skirts	164	€ 3.830,00
SX Left	STARBITS	Vasca con pannelli Bathtub with skirts	164	€ 3.830,00

Motore Whirlpool / Whirlpool Pump: 1 Cv / 1 Hp
 Motore Airpool / Airpool Pump: 650 Watt / Volts 220/230, 50-60 Hz
 Sonda di livello / Level probe
 Colonna di scarico inclusa / Drain pipe included



WHIRLPOOL + AIRPOOL +
 CROMOTERAPIA + DISINFEZIONE
 WHIRLPOOL + AIRPOOL +
 CHROMOTHERAPY + DISINFECTION
 (PAG. 62)
 Whirlpool jets: n. 7
 Airpool jets: n. 12



ACCESSORI ACCESORIES



Cod.	Descrizione Description	Bianco White
PROFBV	Profilo bordo vasca Bath tub rim finish	€ 70,00
STARSED	Sedile STAR Seat	€ 144,00
CT01	KIT CROMOTERAPIA installato sul cappello CHROMOTHERAPY KIT installed on the roof	€ 340,00

SISTEMI IDROMASSAGGIO

HYDRO-MASSAGE SYSTEMS

VASCHE SHARM e VASCHE CLASSIC / SHARM AND CLASSIC BATHTUBS

SISTEMA IDRO+ IDRO+ SYSTEM



Whirlpool / Whirlpool
Cromoterapia / Chromotherapy

SISTEMA IDRO-TECNO IDRO-TECNO SYSTEM



Whirlpool / Whirlpool
Airpool / Airpool
Cromoterapia / Chromotherapy
Disinfezione / Disinfection
Ricarica detergente / Detergent refill



GETTO AIRPOOL
AIRPOOL JET

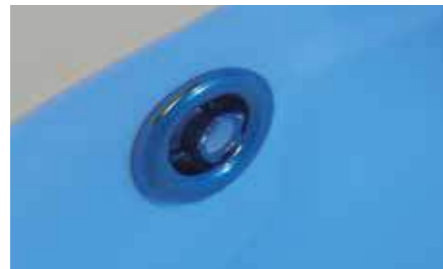

GETTO WHIRLPOOL
WHIRLPOOL JET



FARO CROMOTERAPIA A LED
LED CHROMOTHERAPY LIGHT

SEDILI SEATS



Vasca Classic FANTASY
Classic FANTASY bathtub



Vasca Classic WAP
Vasca Combinata WAP BOX
Classic WAP bathtub
WAP Bathtub with shower enclosure



Vasca Classic STAR
Vasca Combinata STAR BOX
Classic STAR bathtub
STAR Bathtub with shower enclosure

CUSCINI CUSHIONS



Vasca Sharm ANGOLARE
e ASIMMETRICA
SHARM ANGOLARE and
ASIMMETRICA bathtub



Vasca Sharm QUADRATA
SHARM QUADRATA
bathtub

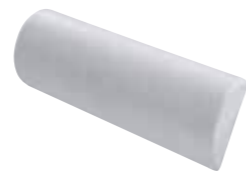

Vasca Sharm RETTANGOLARE
SHARM RETTANGOLARE bathtub

Cuscini in dotazione esclusivamente per le vasche SHARM

Only for SHARM bathtubs



RUBINETTERIA 4 FORI FOUR-HOLE TAP SET



Doccino estraibile /
Extractable hand shower
Bocca di erogazione / Bath spout
Miscelatore / Mixer
Deviatore / Diverter

RUBINETTERIA 3 FORI THREE-HOLE TAP SET



Doccino estraibile /
Extractable hand shower
Miscelatore / Mixer
Deviatore / Diverter
Colonna di scarico con erogatore / Overflow drain inclusive of fill spout

NOTE: La sequenza di installazione degli elementi della rubinetteria può variare in base al modello della vasca.
The tap installation sequence make change on the basis of the bathtub model.

PROFILI BORDO VASCA BATHTUB EDGE PROFILES

Profilo bordo vasca bianco di rifinitura e impermeabilizzazione tra parete e vasca

The white bathtub edge finish and seal between wall and bathtub



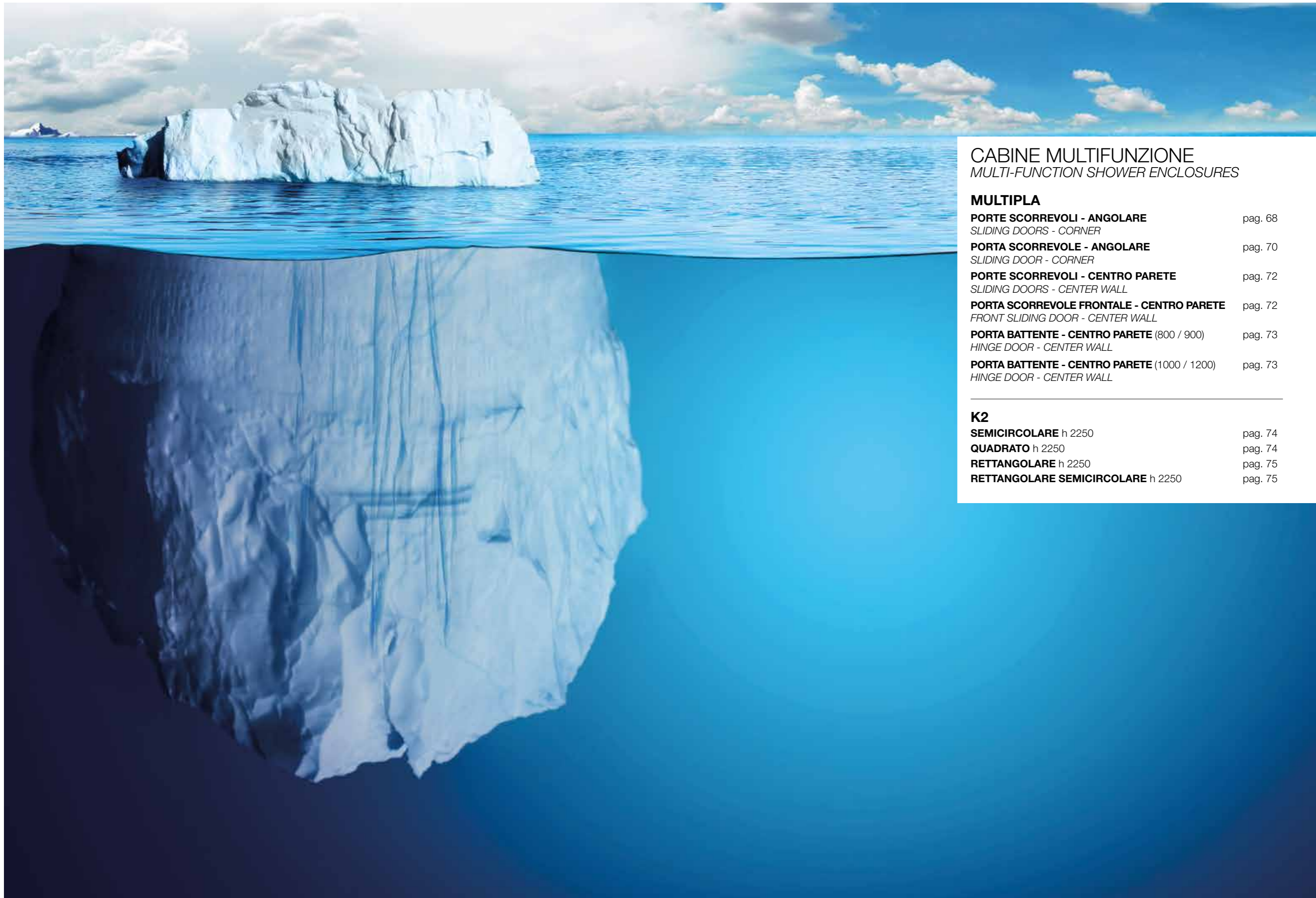

CABINE MULTIFUNZIONE MULTI-FUNCTION SHOWER ENCLOSURES

MULTIPLA

PORTE SCORREVOLI - ANGOLARE <i>SLIDING DOORS - CORNER</i>	pag. 68
PORTA SCORREVOLE - ANGOLARE <i>SLIDING DOOR - CORNER</i>	pag. 70
PORTE SCORREVOLI - CENTRO PARETE <i>SLIDING DOORS - CENTER WALL</i>	pag. 72
PORTA SCORREVOLE FRONTALE - CENTRO PARETE <i>FRONT SLIDING DOOR - CENTER WALL</i>	pag. 72
PORTA BATTENTE - CENTRO PARETE (800 / 900) <i>HINGE DOOR - CENTER WALL</i>	pag. 73
PORTA BATTENTE - CENTRO PARETE (1000 / 1200) <i>HINGE DOOR - CENTER WALL</i>	pag. 73

K2

SEMICIRCOLARE h 2250	pag. 74
QUADRATO h 2250	pag. 74
RETTANGOLARE h 2250	pag. 75
RETTANGOLARE SEMICIRCOLARE h 2250	pag. 75

MULTIPLA

Porte scorrevoli - Angolare
Sliding doors - Corner

STRUTTURA: ACRILICO BIANCO
STRUCTURE: WHITE ACRYLIC

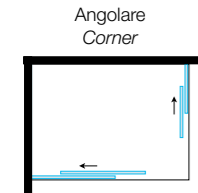

Versione / Version:
CIELO **CON** SOFFIONE QUADRATO INTEGRATO
E CROMOTERAPIA
ROOF **WITH** INTEGRATED SQUARE HEAD SHOWER
AND CHROMOTHERAPY



SX - Left
Piatto doccia acrilico
Acrylic shower tray
H110 mm

Soffione quadrato 200X200 mm
Miscelatore meccanico
Deviatore a 3 vie
Asta saliscendi con doccino multifunzione
Getti nebulizzati: n.8
Parete attrezzata in lastra unica
Mensola integrata
Piatto doccia h 50 mm oppure con telaio e piedini regolabili h 110 mm
Piletta di scarico cromo
Porte scorrevoli in cristallo temperato 6 mm, h 2000 mm
Easy clean
Ante a sgancio rapido
Finitura cromo silver

200X200 mm square head shower
Mechanical mixer
Three way diverter
Hand shower on adjustable sliding rail
Vaporized jets: n. 8
One-piece thermo-formed acrylic panel
Integrated shelf
H 50 mm shower tray or with frame and adjustable feet h 110 mm
Chrome drain cover
6mm tempered glass sliding door, h 2000 mm
Easy clean
Quick release doors
Polished aluminum profiles

Cod.	Misure Sizes	Altezza piatto doccia Shower tray high		Cod. BV Bianco velvet White velvet	
		H50	H110		
MTP8080C	H50 / H110	800x800	€ 2.785,00	€ 2.821,00	€ + 15%
MTP9090C	H50 / H110	900x900	€ 3.000,00	€ 3.040,00	
MTP100100C	H50 / H110	1000x1000	€ 2.858,00	€ 2.895,00	
MTP7290C	H50 / H110	720x900	€ 2.785,00	€ 2.822,00	
MTP70100C	H50 / H110	700x1000	€ 2.795,00	€ 2.830,00	
MTP70120C	H50 / H110	700x1200	€ 2.825,00	€ 2.862,00	
MTP70140C	H50 / H110	700x1400	€ 2.906,00	€ 2.943,00	
MTP80100C	H50 / H110	800x1000	€ 2.828,00	€ 2.865,00	
MTP80120C	H50 / H110	800x1200	€ 2.868,00	€ 2.905,00	
MTP80140C	H50 / H110	800x1400	€ 2.892,00	€ 2.929,00	

SPECIFICARE SEMPRE IL VERSO ALL'ORDINE **DX / SX**
ALWAYS SPECIFY THE TYPE WHEN PLACING THE ORDER **RIGHT / LEFT**

Versione / Version:
SENZA CIELO
WITHOUT ROOF



SX - Left
Piatto doccia acrilico
Acrylic shower tray
H50 mm

Cod.	Misure Sizes	Altezza piatto doccia Shower tray high		Cod. BV Bianco velvet White velvet	
		H50	H110		
MTP8080	H50 / H110	800x800	€ 2.372,00	€ 2.405,00	€ + 15%
MTP9090	H50 / H110	900x900	€ 2.490,00	€ 2.526,00	
MTP100100	H50 / H110	1000x1000	€ 2.418,00	€ 2.454,00	
MTP7290	H50 / H110	720x900	€ 2.373,00	€ 2.409,00	
MTP70100	H50 / H110	700x1000	€ 2.377,00	€ 2.414,00	
MTP70120	H50 / H110	700x1200	€ 2.400,00	€ 2.437,00	
MTP70140	H50 / H110	700x1400	€ 2.476,00	€ 2.513,00	
MTP80100	H50 / H110	800x1000	€ 2.398,00	€ 2.435,00	
MTP80120	H50 / H110	800x1200	€ 2.426,00	€ 2.463,00	
MTP80140	H50 / H110	800x1400	€ 2.444,00	€ 2.481,00	

SPECIFICARE SEMPRE IL VERSO ALL'ORDINE **DX / SX**
ALWAYS SPECIFY THE TYPE WHEN PLACING THE ORDER **RIGHT / LEFT**

OPTIONAL



(pag 70)

Bagno turco
Luce bianca
Cromoterapia
Radio FM
Aux
Bagno turco
Luce bianca
Cromoterapia
Radio FM
Aux

Cod.	Descrizione Description	Bianco White
KCM01	KIT MULTIFUNZIONE MULTI-FUNCTION KIT	€ 1.090,00

NB: Optional esclusivo della cabina con cielo di chiusura.
NOTE: Additional optional in exclusivity for the cabin with closing roof.

VERSIONI / VERSIONS

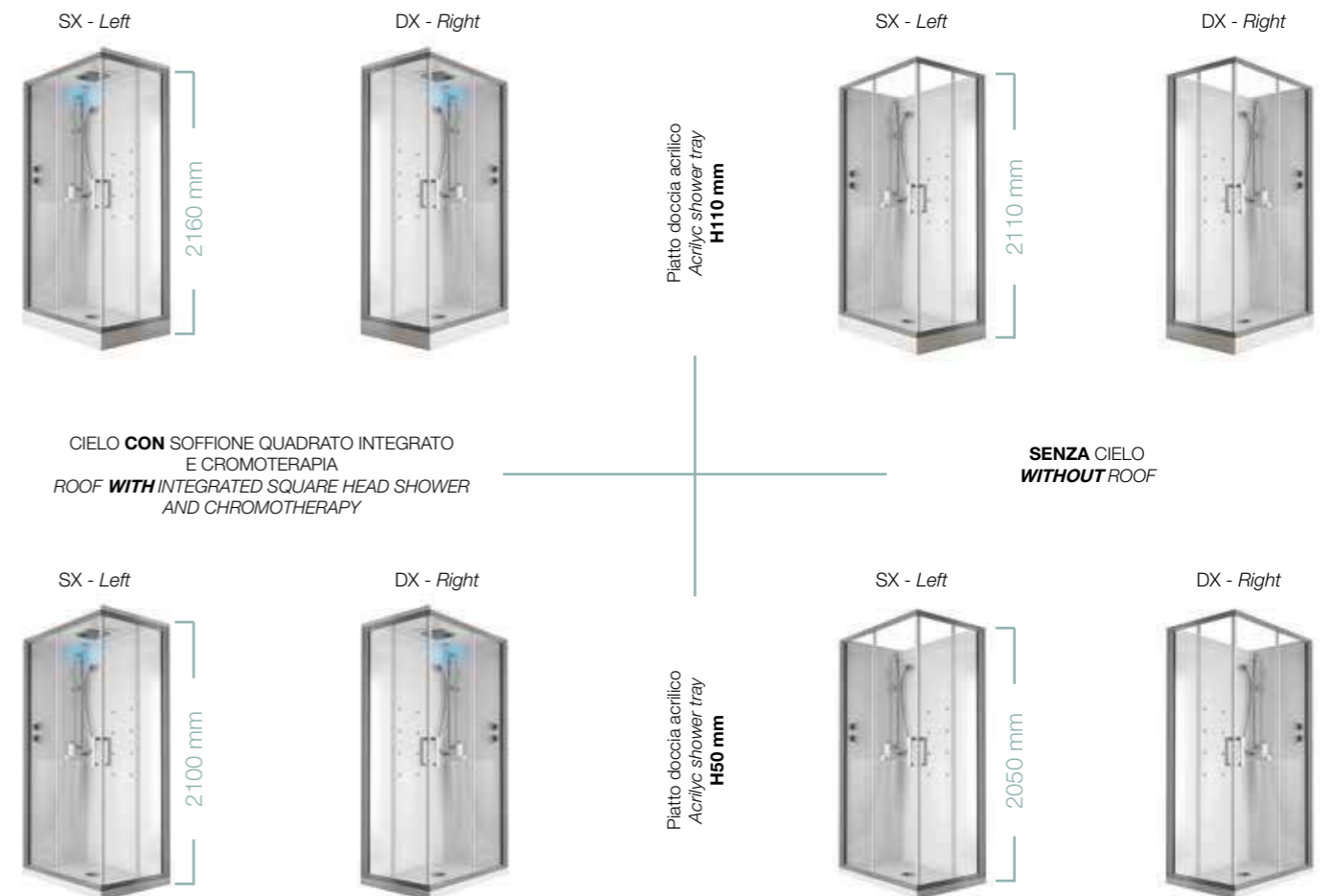

MULTIPLA

Porta scorrevole - Angolare
Sliding door - Corner

Soffione quadrato 200X200 mm
Miscelatore meccanico
Deviatore a 3 vie
Asta saliscendi con doccino multifunzione
Getti nebulizzati: n.8
Parete attrezzata in lastra unica
Mensola integrata
Piatto doccia h 50 mm oppure con telaio e piedini regolabili h 110 mm
Piletta di scarico cromo
Porte scorrevoli in cristallo temperato 6 mm, h 2000 mm
Easy clean
Ante a sgancio rapido
Finitura cromo silver

200X200 mm square head shower
Mechanical mixer
Three way diverter
Hand shower on adjustable sliding rail
Vaporized jets: n. 8
One-piece thermo-formed acrylic panel
Integrated shelf
H 50 mm shower tray or with frame and adjustable feet h 110 mm
Chrome drain cover
6mm tempered glass sliding door, h 2000 mm
Easy clean
Quick release doors
Polished aluminum profiles

STRUTTURA: ACRILICO BIANCO
STRUCTURE: WHITE ACRYLIC

Centro Parete
Center Wall

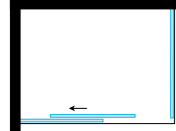

Versione / Version:
CIELO **CON** SOFFIONE QUADRATO INTEGRATO
E CROMOTERAPIA
ROOF **WITH** INTEGRATED SQUARE HEAD SHOWER
AND CHROMOTHERAPY



2160 mm

Piatto doccia acrilico
Acrylic shower tray
H110 mm

SX - Left

Versione / Version:
SENZA CIELO
WITHOUT ROOF



2050 mm

Piatto doccia acrilico
Acrylic shower tray
H50 mm

SX - Left

Cod.	Misure Sizes	Altezza piatto doccia Shower tray high		Cod. BV Bianco velvet White velvet
		H50	H110	
MTP70100CAF	H50 / H110 700x1000	€ 2.940,00	€ 2.975,00	€ + 15%
MTP70120CAF	H50 / H110 700x1200	€ 2.960,00	€ 3.000,00	
MTP70140CAF	H50 / H110 700x1400	€ 3.040,00	€ 3.070,00	
MTP80100CAF	H50 / H110 800x1000	€ 2.970,00	€ 3.000,00	
MTP80120CAF	H50 / H110 800x1200	€ 3.000,00	€ 3.035,00	
MTP80140CAF	H50 / H110 800x1400	€ 3.020,00	€ 3.060,00	

SPECIFICARE SEMPRE IL VERSO ALL'ORDINE **DX / SX**
ALWAYS SPECIFY THE TYPE WHEN PLACING THE ORDER **RIGHT / LEFT**

Cod.	Misure Sizes	Altezza piatto doccia Shower tray high		Cod. BV Bianco velvet White velvet
		H50	H110	
MTP70100AF	H50 / H110 700x1000	€ 2.520,00	€ 2.560,00	€ + 15%
MTP70120AF	H50 / H110 700x1200	€ 2.530,00	€ 2.570,00	
MTP70140AF	H50 / H110 700x1400	€ 2.610,00	€ 2.640,00	
MTP80100AF	H50 / H110 800x1000	€ 2.540,00	€ 2.580,00	
MTP80120AF	H50 / H110 800x1200	€ 2.560,00	€ 2.595,00	
MTP80140AF	H50 / H110 800x1400	€ 2.570,00	€ 2.610,00	

SPECIFICARE SEMPRE IL VERSO ALL'ORDINE **DX / SX**
ALWAYS SPECIFY THE TYPE WHEN PLACING THE ORDER **RIGHT / LEFT**

OPTIONAL



(pag 70)

Bagno turco
Luce bianca
Cromoterapia
Radio FM
Aux

Bagno turco
Luce bianca
Cromoterapia
Radio FM
Aux

Cod.	Descrizione Description	Bianco White
KCM01	KIT MULTIFUNZIONE MULTI-FUNCTION KIT	€ 1.090,00

NB: Optional esclusivo della cabina con cielo di chiusura.
NOTE: Additional optional in exclusivity for the cabin with closing roof.

VERSIONI / VERSIONS

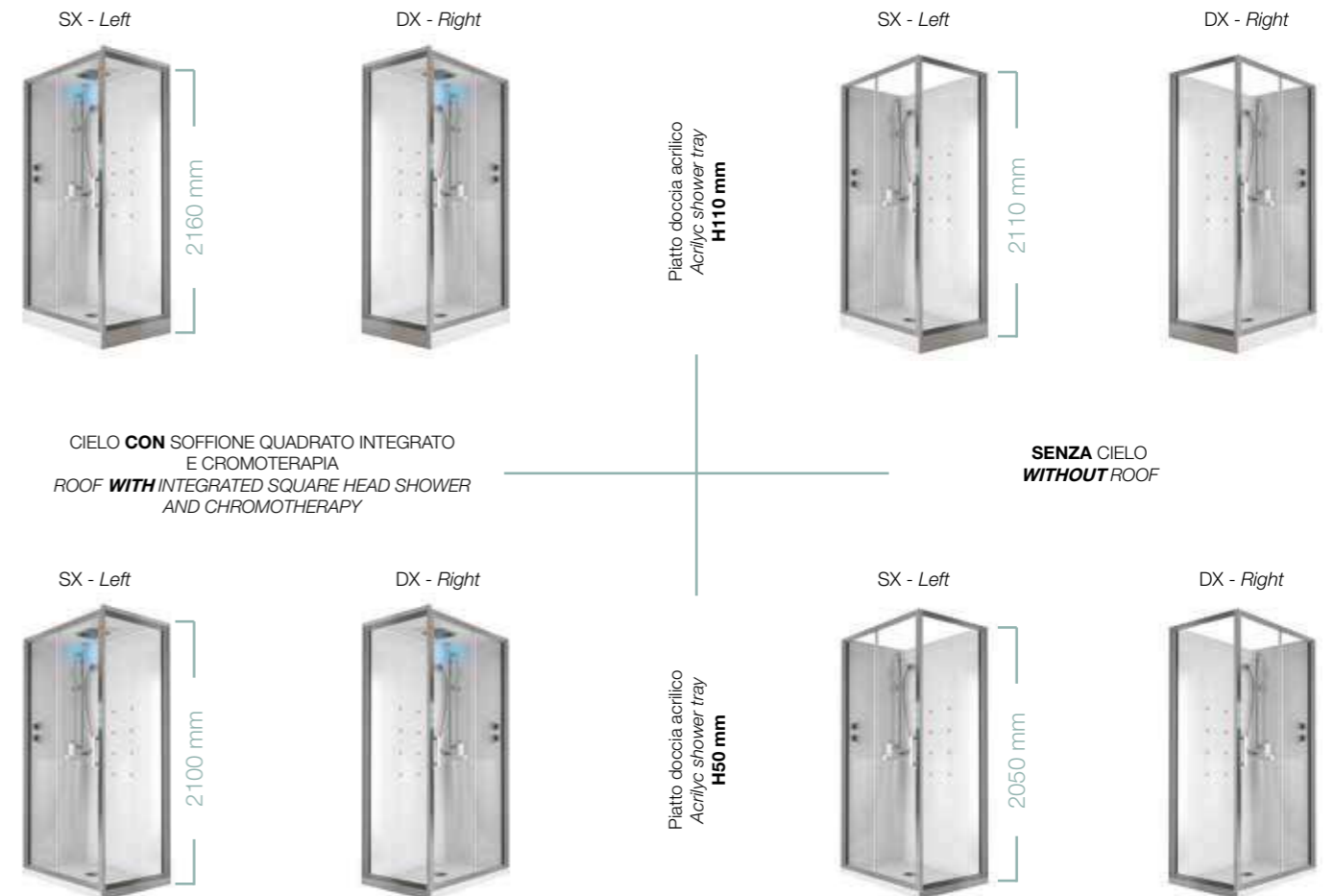

MULTIPLA

Porte scorrevoli - Centro Parete
Sliding doors - Center Wall

STRUTTURA: ACRILICO BIANCO
STRUCTURE: WHITE ACRYLIC

Cielo con soffione quadrato integrato 200x200 mm
Cromoterapia
Miscelatore meccanico
Deviatore a 3 vie
Asta saliscendi con doccino multifunzione
Getti nebulizzati: n.8 (solo per 1200 e 1400 mm)
Parete attrazzata in lastra unica
Mensola integrata
Piatto doccia con telaio e piedini regolabili h 110 mm
Piatto doccia h 50 mm
Piletta di scarico cromo
Chiusura scorrevole in cristallo temperato 6 mm
Ante a sgancio rapido
Finitura cromo silver

Roof with integrated 200x200 mm square head shower
Chromotherapy
Mechanical mixer
Three way diverter
Hand shower on adjustable sliding rail
Vaporized jets: n. 8 (only for 1200 and 1400 mm)
One-piece thermo-formed acrylic panel
Integrated shelf
Shower tray with frame and adjustable feet h 110 mm
Shower tray h 50 mm
Chrome drain cover
6mm tempered glass sliding door
Quick release doors
Polished aluminum profiles



Piatto doccia acrilico
Acrylic shower tray
H50 mm

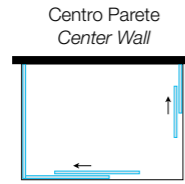

Cod.	Misure Sizes	Altezza piatto doccia Shower tray high		Cod. BV Bianco velvet White velvet
		H50	H110	
MTP70100CA	H50 / H110 700x1000	€ 2.580,00	€ 2.615,00	€ + 15%
MTP70120CA	H50 / H110 700x1200	€ 3.170,00	€ 3.200,00	
MTP70140CA	H50 / H110 700x1400	€ 3.250,00	€ 3.280,00	
MTP80100CA	H50 / H110 800x1000	€ 2.680,00	€ 2.720,00	
MTP80120CA	H50 / H110 800x1200	€ 3.270,00	€ 3.310,00	
MTP80140CA	H50 / H110 800x1400	€ 3.330,00	€ 3.370,00	

OPTIONAL



Bagno turco
Luce bianca
Cromoterapia
Radio FM
Aux

Bagno turco
Luce bianca
Cromoterapia
Radio FM
Aux

Cod.	Descrizione Description	Bianco White
KCM01	KIT MULTIFUNZIONE MULTI-FUNCTION KIT	€ 1.090,00

NB: Optional esclusivo della cabina con cielo di chiusura.
NOTE: Additional optional in exclusivity for the cabin with closing roof.



Piatto doccia acrilico
Acrylic shower tray
H50 mm

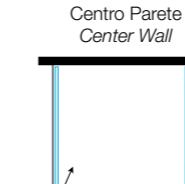

Cod.	Misure Sizes	Altezza piatto doccia Shower tray high		Cod. BV Bianco velvet White velvet
		H50	H110	
MTP8080CB	H50 / H110 800x800	€ 2.590,00	€ 2.630,00	€ + 15%
MTP9090CB	H50 / H110 900x900	€ 2.740,00	€ 2.780,00	€ + 15%



Piatto doccia acrilico
Acrylic shower tray
H110 mm

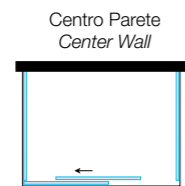

Cod.	Misure Sizes	Altezza piatto doccia Shower tray high		Cod. BV Bianco velvet White velvet
		H50	H110	
MTP70100CF	H50 / H110 700x1000	€ 2.350,00	€ 2.690,00	€ + 15%
MTP70120CF	H50 / H110 700x1200	€ 3.230,00	€ 3.270,00	
MTP70140CF	H50 / H110 700x1400	€ 3.310,00	€ 3.350,00	
MTP80100CF	H50 / H110 800x1000	€ 2.750,00	€ 2.790,00	
MTP80120CF	H50 / H110 800x1200	€ 3.340,00	€ 3.375,00	
MTP80140CF	H50 / H110 800x1400	€ 3.390,00	€ 3.430,00	



Piatto doccia acrilico
Acrylic shower tray
H50 mm

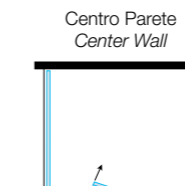

Cod.	Misure Sizes	Altezza piatto doccia Shower tray high		Cod. BV Bianco velvet White velvet
		H50	H110	
MTP100100CBF	H50 / H110 1000x1000	€ 2.900,00	€ 2.940,00	€ + 15%
MTP70100CBF	H50 / H110 700x1000	€ 2.660,00	€ 2.700,00	
MTP70120CBF	H50 / H110 700x1200	€ 3.250,00	€ 3.290,00	
MTP80100CBF	H50 / H110 800x1000	€ 2.760,00	€ 2.800,00	
MTP80120CBF	H50 / H110 800x1200	€ 3.350,00	€ 3.390,00	

K2 - H 2250 mm

versione **BASE**
BASIC version

Cielo con carter di rifinitura
Miscelatore meccanico
Deviatore a 4 vie
Soffione integrato ø 24 cm
Luce bianca a led
Asta saliscendi con doccino multifunzione
Idrogetti orientabili: n.11
Parete attrazzata in lastra unica
Seduta e Mensole integrate
Piatto doccia con telaio e piedini regolabili
Piletta di scarico cromo
Chiusura scorrevole in cristallo temperato 6 mm
Ante a sgancio rapido solo su **Semicircolari**
Finitura cromo silver

Roof with cover
Mechanical mixer
Four way diverter
Integrated ø 24 cm shower head
Led white light
Hand shower on adjustable sliding rail
Adjustable jets: n. 11
One-piece thermo-formed acrylic panel
Integrated seat and shelves
Shower tray with frame and adjustable feet
Chrome drain cover
6mm tempered glass sliding door
Quick release doors only on **Semicircular**
Polished aluminum profiles

STRUTTURA: ACRILICO BIANCO
STRUCTURE: WHITE ACRYLIC

SEMICIRCOLARE SEMICIRCULAR

versione **BASE / BASIC version**



Cod.	Descrizione Description	Kg	Bianco White
K2S80	800X800	112	€ 1.750,00
K2S90	900X900	128	€ 1.800,00
K2S100	1000X1000	150	€ 1.830,00

LUCE BIANCA SEMPRE INCLUSA
WHITE LIGHT ALWAYS INCLUDED

QUADRATO SQUARE

versione **BASE / BASIC version**



Cod.	Descrizione Description	Kg	Bianco White
K2Q80	800X800	112	€ 1.790,00
K2Q90	900X900	128	€ 1.810,00
K2Q100	1000X1000	150	€ 1.840,00

LUCE BIANCA SEMPRE INCLUSA
WHITE LIGHT ALWAYS INCLUDED

OPTIONAL



(pag 70)

Bagno turco
Luce bianca
Cromoterapia
Radio FM
Aux
Bagno turco
Luce bianca
Cromoterapia
Radio FM
Aux

Cod.	Descrizione Description	Bianco White
KCM01	KIT MULTIFUNZIONE MULTI-FUNCTION KIT	€ 1.090,00

K2 - H 2250 mm

versione **BASE**
BASIC version

Cielo con carter di rifinitura
Miscelatore meccanico
Deviatore a 4 vie
Soffione integrato ø 24 cm
Luce bianca a led
Asta saliscendi con doccino multifunzione
Idrogetti orientabili: n.11
Parete attrazzata in lastra unica
Seduta e Mensole integrate
Piatto doccia con telaio e piedini regolabili
Piletta di scarico cromo
Chiusura scorrevole in cristallo temperato 6 mm
Ante a sgancio rapido solo su **Semicircolari**
Finitura cromo silver

Roof with cover
Mechanical mixer
Four way diverter
Integrated ø 24 cm shower head
Led white light
Hand shower on adjustable sliding rail
Adjustable jets: n. 11
One-piece thermo-formed acrylic panel
Integrated seat and shelves
Shower tray with frame and adjustable feet
Chrome drain cover
6mm tempered glass sliding door
Quick release doors only on **Semicircular**
Polished aluminum profiles

STRUTTURA: ACRILICO BIANCO
STRUCTURE: WHITE ACRYLIC

RETTANGOLARE SEMICIRCOLARE SEMICIRCULAR RECTANGULAR

versione **BASE / BASIC version**



Cod.	Descrizione Description	Kg	Bianco White
DX right K2RS9070D	900x700	126	€ 1.790,00
SX left K2RS9070S	900x700	126	€ 1.790,00
DX right K2RS10070D	1000x700	134	€ 1.815,00
SX left K2RS10070S	1000x700	134	€ 1.815,00

LUCE BIANCA SEMPRE INCLUSA
WHITE LIGHT ALWAYS INCLUDED

RETTANGOLARE RECTANGULAR

versione **BASE / BASIC version**



Cod.	Descrizione Description	Kg	Bianco White
DX right K2R9070D	900x700	126	€ 1.800,00
SX left K2R9070S	900x700	126	€ 1.800,00
DX right K2R10070D	1000x700	134	€ 1.825,00
SX left K2R10070S	1000x700	134	€ 1.825,00

LUCE BIANCA SEMPRE INCLUSA
WHITE LIGHT ALWAYS INCLUDED

OPTIONAL



(pag 70)

Bagno turco
Luce bianca
Cromoterapia
Radio FM
Aux
Bagno turco
Luce bianca
Cromoterapia
Radio FM
Aux

Cod.	Descrizione Description	Bianco White
KCM01	KIT MULTIFUNZIONE MULTI-FUNCTION KIT	€ 1.090,00

SISTEMI IDROMASSAGGIO

HYDRO-MASSAGE SYSTEMS

// SISTEMI IDROMASSAGGIO_HYDRO-MASSAGE SYSTEMS

CABINE MULTIFUNZIONE / MULTI-FUNCTION SHOWER ENCLOSURES

KIT MULTIFUNZIONE MULTI-FUNCTION KIT

Mod. MULTIPLA
Mod. K2

Bagno Turco / Turkish bath+

Faro Cromoterapia a LED / LED chromotherapy Light

Radio FM / FM Radio

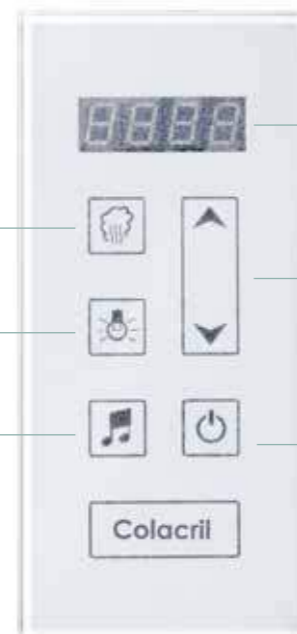

LCD Display / LCD Display

+ o - Funzioni Kit / + or - Mode change

ACCESO-SPENTO / ON-OFF

MULTIPLA



Soffione quadrato integrato 200x200 mm
Integrated 200x200 mm square head shower



Getto nebulizzato
Vaporizing jet



Rubinetteria e comando luce cromoterapia
Tap and chromotherapy light control panel



Diffusore vapore con contenitore sali
Steam diffuser with salt container



Faro cromoterapia a LED
LED chromotherapy Light



Cassa altoparlante
Speaker

K2



Doccino multifunzione e getto orientabile
Multi-function hand shower and adjustable jet



Soffione integrato ø 24 cm
Integrated head shower ø 24 cm



Miscelatore meccanico e deviatore a 4 vie
Mechanical mixer and four-way diverter



Diffusore vapore con contenitore sali
Steam diffuser with salt container



Faro cromoterapia a LED
LED chromotherapy Light



Cassa altoparlante
Speaker

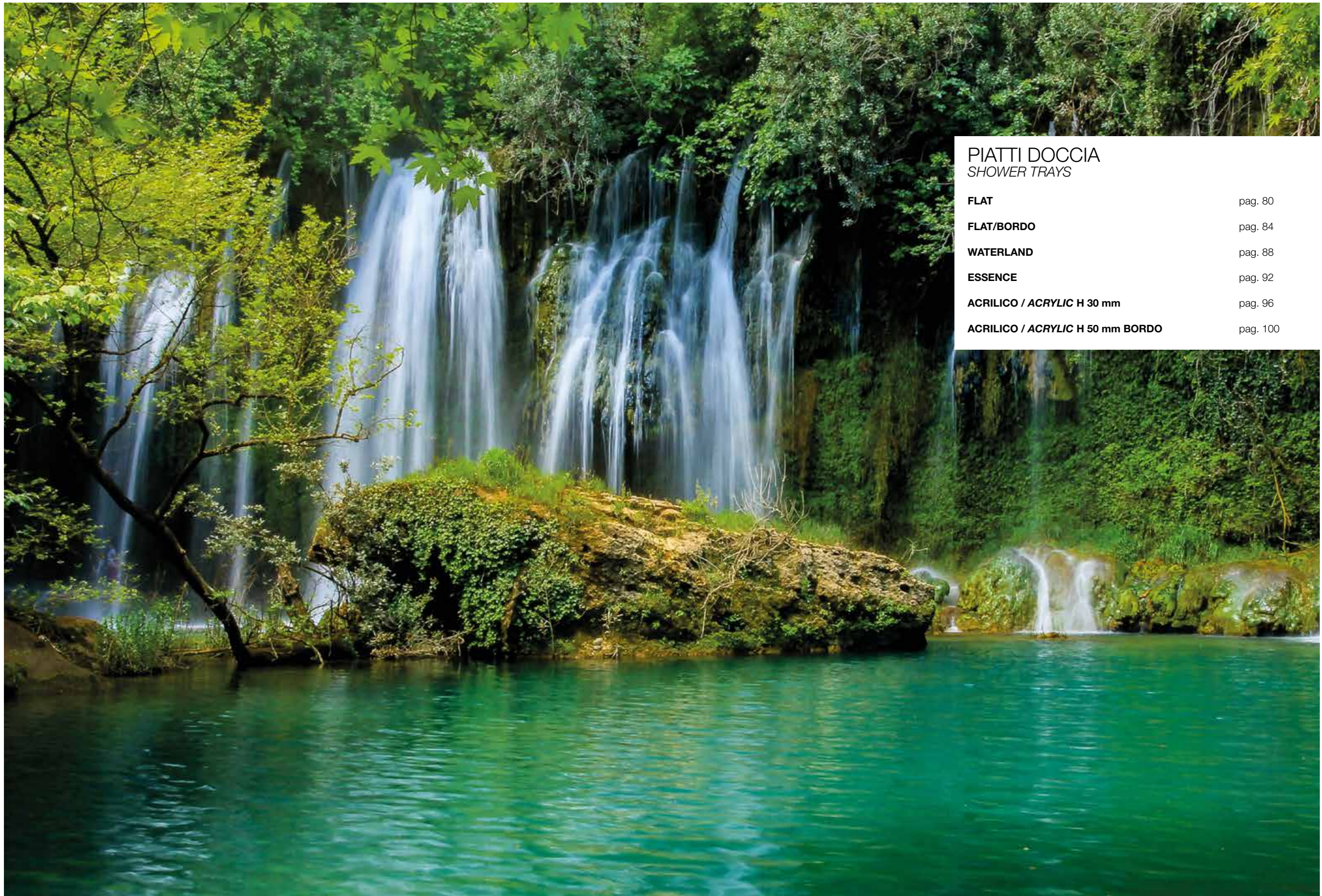

PIATTI DOCCIA
SHOWER TRAYS

FLAT	pag. 80
FLAT/BORDO	pag. 84
WATERLAND	pag. 88
ESSENCE	pag. 92
ACRILICO / ACRYLIC H 30 mm	pag. 96
ACRILICO / ACRYLIC H 50 mm BORDO	pag. 100

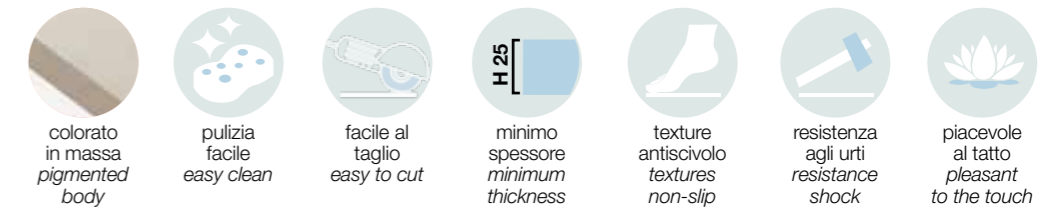

FLAT

Piatti doccia / Shower trays

La resina miscelata con minerali garantisce elevate prestazioni tecniche e strutturali ed è ideale sia per ambienti interni che esterni.
L'impasto è totalmente pigmentato all'interno e simile alla superficie del piatto doccia, antiscivolo con trama pietra.

MARBLE RESIN SHOWER TRAYS

Resin mixed together with minerals guarantees mechanical high-performance and aesthetic features. The shower trays can be installed inside or outdoors. The shower tray body is pigmented in a similar color as the shower tray surface, it is anti-slip and it reproduces a stone surface.

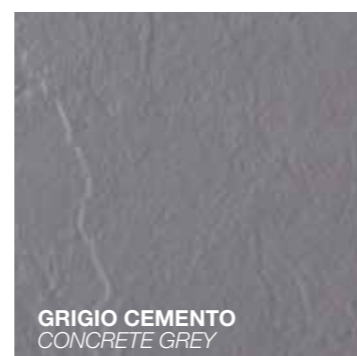

L'IMPASTO È TOTALMENTE PIGMENTATO ALL'INTERNO E SIMILE ALLA SUPERFICIE DEL PIATTO DOCCIA.

THE SHOWER TRAY BODY IS PIGMENTED IN A SIMILAR COLOR AS THE SHOWER TRAY SURFACE.

POSSIBILI TAGLI / CUTTING EXAMPLES



FLAT

piatti doccia in marmoresina/ marble resin shower trays

Specificare sempre la finitura all'ordine.
Always specify the finish when placing the order.

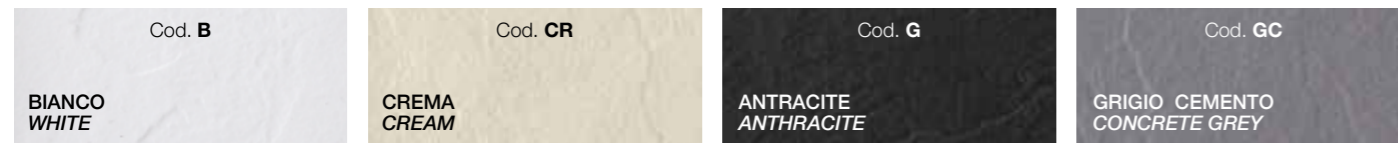

QUADRATO SQUARE



Cod.	Dimensioni Sizes	Kg	Bianco White	Colorati Colored
PDM8080H25	800X800 h 25 mm	29	€ 325,00	€ 330,00
PDM9090H25	900X900 h 25 mm	37	€ 390,00	€ 400,00

RETTANGOLARE RECTANGULAR

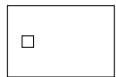

Dettaglio del grigliato del piatto doccia in marmo resina H 30 mm. Il piatto doccia H 25 mm ha una superficie liscia.

Detail of the shower tray grating in marble-resin 30 mm High. The 25 mm high shower tray has a smooth surface.



Cod.	Dimensioni Sizes	Kg	Bianco White	Colorati Colored
PDM7290H25	720X900 h 25 mm	30	€ 324,00	€ 340,00
PDM70100H25	700X1000 h 25 mm	31	€ 344,00	€ 355,00
PDM70120H25	700X1200 h 25 mm	39	€ 394,00	€ 405,00
PDM70140H25	700X1400 h 25 mm	46	€ 444,00	€ 455,00
PDM70160H25	700X1600 h 25 mm	50	€ 494,00	€ 505,00
PDM70170H25	700X1700 h 25 mm	52	€ 514,00	€ 524,00
PDM70180H25	700X1800 h 25 mm	58	€ 544,00	€ 555,00
PDM80100H25	800X1000 h 25 mm	36	€ 384,00	€ 394,00
PDM80120H25	800X1200 h 25 mm	43	€ 440,00	€ 450,00
PDM80140H25	800X1400 h 25 mm	52	€ 485,00	€ 495,00
PDM80160H25	800X1600 h 25 mm	56	€ 539,00	€ 549,00
PDM80170H25	800X1700 h 25 mm	60	€ 569,00	€ 584,00
PDM80180H25	800X1800 h 25 mm	64	€ 589,00	€ 599,00
PDM90100H25	900X1000 h 25 mm	38	€ 430,00	€ 433,00
PDM90120H25	900X1200 h 25 mm	50	€ 503,00	€ 507,00
PDM90140H30	900X1400 h 30 mm	56	€ 562,00	€ 567,00
PDM90160H30	900X1600 h 30 mm	64	€ 659,00	€ 665,00
PDM90170H30	900X1700 h 30 mm	68	€ 688,00	€ 694,00
PDM90180H30	900X1800 h 30 mm	73	€ 718,00	€ 725,00

SEMICIRCOLARE SEMICIRCULAR

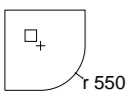

Cod.	Dimensioni Sizes	Kg	Bianco White	Colorati Colored
PDSM8080H25	800X800 h 25 mm	27	€ 305,00	€ 315,00
PDSM9090H25	900X900 h 25 mm	34	€ 375,00	€ 385,00

SPECIFICHE TECNICHE TECHNICAL DETAILS

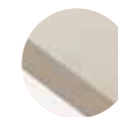

colorato in massa pigmented body



pulizia facile easy clean



facile al taglio easy to cut

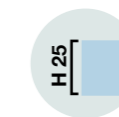

minimo spessore minimum thickness



texture antiscivolo textures non-slip



resistenza agli urti resistance shock



piacevole al tatto pleasant to the touch

NB: disponibile il kit per il ripristino dei piatti doccia
NOTE: available reparation kit for the shower trays recovering

TAGLIO AL CM Custom cutting

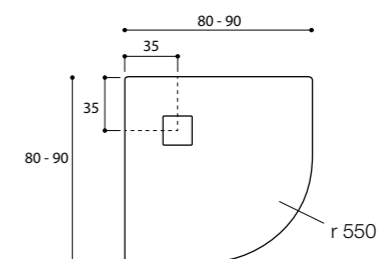
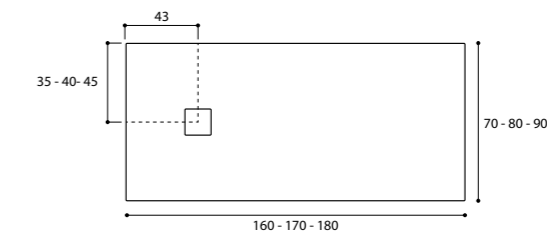
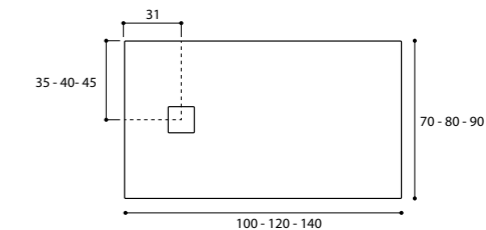
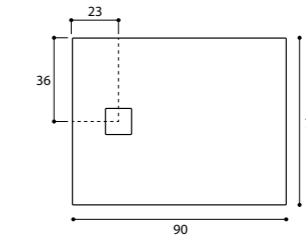
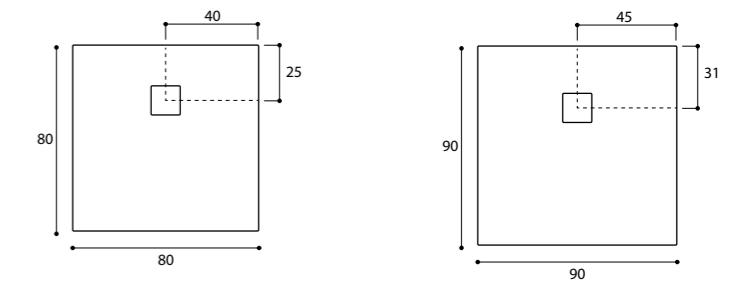

Piletta di scarico e copertura in acciaio inox inclusa
Siphon and stainless steel drain cover included



Cod. 700009
€ 18,00



colorato
in massa
pigmented
body



pulizia
facile
easy clean

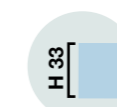

minimo
spessore
minimum
thickness



texture
antiscivolo
textures
non-slip



resistenza
agli urti
resistance
shock



piacevole
al tatto
pleasant
to the touch

FLAT/BORDO

Piatti doccia / Shower trays

Piatto doccia realizzato in marmo-resina con una particolare texturizzazione che conferisce alla superficie del piatto doccia stesso, un elegante effetto "stone". Il bordo su tutti i lati esterni conferisce al piatto doccia una base solida su cui installare il box doccia. Fornito in 4 colori, tutti molto moderni ed adattabili ad ogni tipo di arredo.

MARBLE RESIN SHOWER TRAYS

Shower tray made of marble-resin with a special stone effect texture. The shower tray edge offers a solid base for the installation of the shower enclosure. Offered in four modern colors which can adapt to any kind of furnishing.



L'IMPASTO È TOTALMENTE PIGMENTATO ALL'INTERNO E SIMILE ALLA SUPERFICIE DEL PIATTO DOCCIA.

THE SHOWER TRAY BODY IS PIGMENTED IN A SIMILAR COLOR AS THE SHOWER TRAY SURFACE.



FLAT/BORDO

piatti doccia in marmoresina/ marble resin shower trays

Specificare sempre la finitura all'ordine.
Always specify the finish when placing the order.

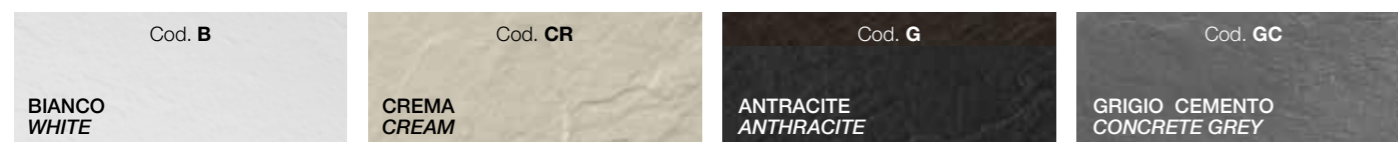

RETTANGOLARE RECTANGULAR

Cod.	Dimensioni Sizes	Kg	Bianco White	Colorati Colored
PDMB7290H33	720X900 h 33 mm	34	€ 366,00	€ 377,00
PDMB70100H33	700X1000 h 33 mm	38	€ 394,00	€ 405,00
PDMB70120H33	700X1200 h 33 mm	43	€ 450,00	€ 455,00
PDMB70140H33	700X1400 h 33 mm	51	€ 500,00	€ 510,00
PDMB70160H33	700X1600 h 33 mm	58	€ 561,00	€ 572,00
PDMB70170H33	700X1700 h 33 mm	65	€ 594,00	€ 602,00
PDMB70180H33	700X1800 h 33 mm	72	€ 624,00	€ 636,00
PDMB80100H33	800X1000 h 33 mm	42	€ 444,00	€ 455,00
PDMB80120H33	800X1200 h 33 mm	50	€ 494,00	€ 505,00
PDMB80140H33	800X1400 h 33 mm	57	€ 544,00	€ 555,00
PDMB80160H33	800X1600 h 33 mm	64	€ 622,00	€ 633,00
PDMB80170H33	800X1700 h 33 mm	71	€ 660,00	€ 672,00
PDMB80180H33	800X1800 h 33 mm	78	€ 699,00	€ 710,00



Dettaglio del fondo liscio sottostante del piatto doccia in marmo resina H 33 mm.

Detail of the smooth underside of the marble-resin shower trays H 33 mm.



SPECIFICHE TECNICHE TECHNICAL DETAILS

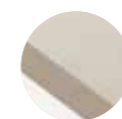

colorato in massa pigmented body



pulizia facile easy clean

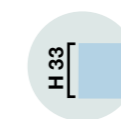

minimo spessore minimum thickness



texture antiscivolo textures non-slip



resistenza agli urti resistance shock



piacevole al tatto pleasant to the touch

NB: disponibile il kit per il ripristino dei piatti doccia
NOTE: available reparation kit for the shower trays recovering

TAGLIO AL CM Custom cutting

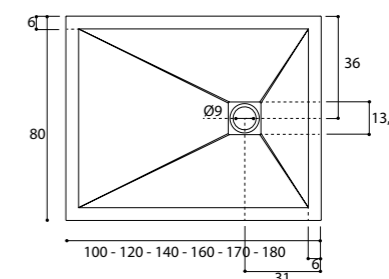
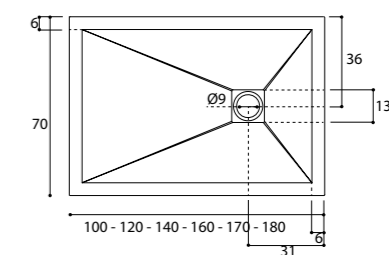
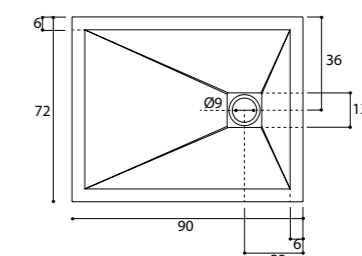

Piletta di scarico e copertura in acciaio inox inclusa
Siphon and stainless steel drain cover included



Cod. 700009
€ 18,00



pulizia facile
easy clean



minimo spessore
minimum thickness



texture antiscivolo
textures non-slip



resistenza agli urti
resistance shock



piacevole al tatto
pleasant to the touch

WATERLAND

Piatti doccia / Shower trays

Waterland è un piatto doccia con pendenza integrata a ridotto spessore. Il buon drenaggio in una doccia è fondamentale per prevenire problemi di acqua stagnante mentre la doccia è in uso, riducendo così i livelli di umidità nella doccia quando la fonte di acqua è spenta.

MARBLE RESIN SHOWER TRAYS

Waterland is a shower tray with a sloping edge rim. Excellent drainage properties are essential to prevent water "pooling" problems while the shower is in use, thus reducing the humidity levels in the shower enclosure once the water source is turned off.



BIANCO
WHITE

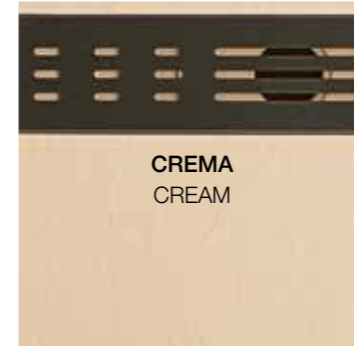

CREMA
CREAM



ANTRACITE
ANTHRACITE



GRIGIO CEMENTO
CONCRETE GREY



SISTEMA DEFLUSSO DELL'ACQUA VELOCE
FAST WATER FLOW



BIANCO
WHITE



NERO
BLACK



GRIGIO CEMENTO
CONCRETE GREY



CREMA
CREAM

WATERLAND

piatti doccia in marmoresina/ marble resin shower trays

Specificare sempre la finitura all'ordine.
Always specify the finish when placing the order.

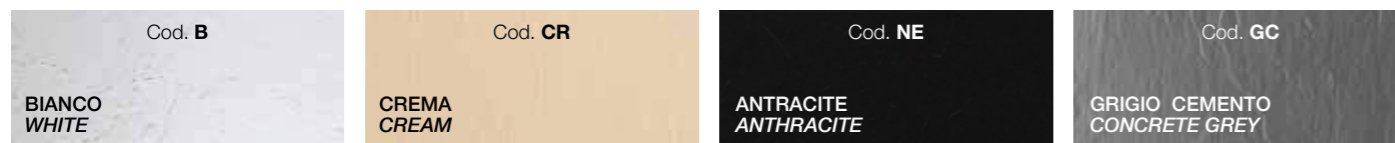

RETTANGOLARE RECTANGULAR

Cod.	Dimensioni Sizes	Kg	Bianco White	Colorati Colored
PDMP70100H40	700x1000 h 40 mm	23	€ 427,00	€ 438,00
PDMP70120H40	700x1200 h 40 mm	27	€ 477,00	€ 488,00
PDMP70140H40	700x1400 h 40 mm	33	€ 555,00	€ 566,00
PDMP70160H40	700x1600 h 40 mm	43	€ 688,00	€ 699,00
PDMP70170H40	700x1700 h 40 mm	53	€ 733,00	€ 744,00
PDMP70180H40	700x1800 h 40 mm	63	€ 785,00	€ 795,00
PDMP80100H40	800x1000 h 40 mm	25	€ 450,00	€ 460,00
PDMP80120H40	800x1200 h 40 mm	30	€ 522,00	€ 532,00
PDMP80140H40	800x1400 h 40 mm	37	€ 594,00	€ 605,00
PDMP80160H40	800x1600 h 40 mm	47	€ 744,00	€ 755,00
PDMP80170H40	800x1700 h 40 mm	50	€ 783,00	€ 793,00
PDMP80180H40	800x1800 h 40 mm	55	€ 844,00	€ 855,00
PDMP90100H40	900x1000 h 40 mm	31	€ 500,00	€ 510,00
PDMP90120H40	900x1200 h 40 mm	34	€ 577,00	€ 588,00
PDMP90140H40	900x1400 h 40 mm	41	€ 660,00	€ 671,00
PDMP90160H40	900x1600 h 40 mm	52	€ 821,00	€ 832,00



Dettaglio del grigliato sottostante del piatto doccia in marmo-resina H 40 mm.

Detail of the gridded underside of the marble-resin shower trays H40 mm.



SPECIFICHE TECNICHE TECHNICAL DETAILS



pulizia facile
easy clean



minimo spessore
minimum thickness



texture antiscivolo
textures non-slip



resistenza agli urti
resistance shock



piacevole al tatto
pleasant to the touch

NB: disponibile il kit per il ripristino dei piatti doccia
NOTE: available reparation kit for the shower trays recovering

TAGLIO AL CM Custom cutting

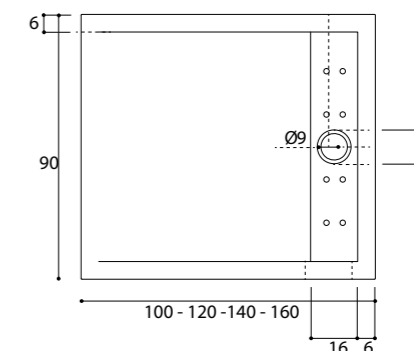
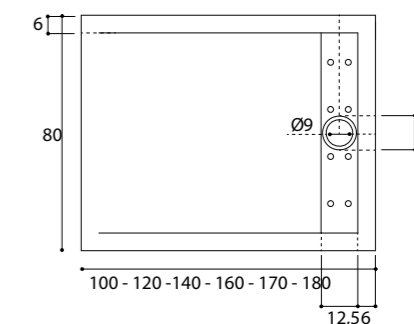
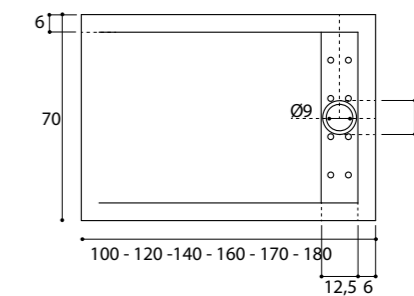

Piletta di scarico e copertura in acciaio inox inclusa
Siphon and stainless steel drain cover included



Cod. 700010
€ 64,00



pulizia
facile
easy clean



facile al
taglio
easy to cut

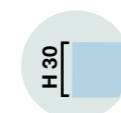

minimo
spessore
minimum
thickness



texture
antiscivolo
textures
non-slip



resistenza
agli urti
resistance
shock



piacevole
al tatto
pleasant
to the touch

ESSENCE

Piatti doccia / Shower trays

La finitura dei piatti Essence ad EFFETTO LEGNO (anche sui bordi) è riducibile e adattabile ai fuori squadra. Dal forte impatto estetico e grazie alla sua versatilità permette la realizzazione di una zona doccia dall'estrema eleganza.

The brand new finish of the WOOD Essence (even on the edges), the Essence can be cut to size and can be installed in out of square corners. With its strong aesthetic impact and thanks to its versatility, it is possible to create a shower area of extreme elegance.

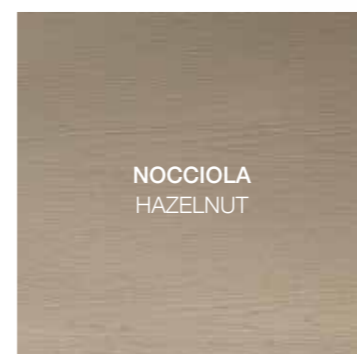
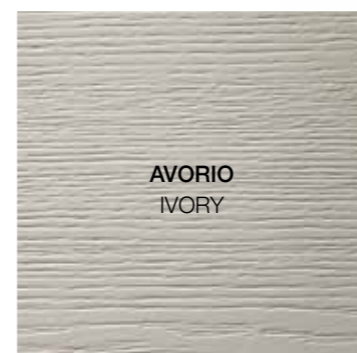

POSSIBILI TAGLI / CUTTING



ESSENCE

piatti doccia in marmoresina/ marble resin shower trays

Specificare sempre la finitura all'ordine.
Always specify the finish when placing the order.

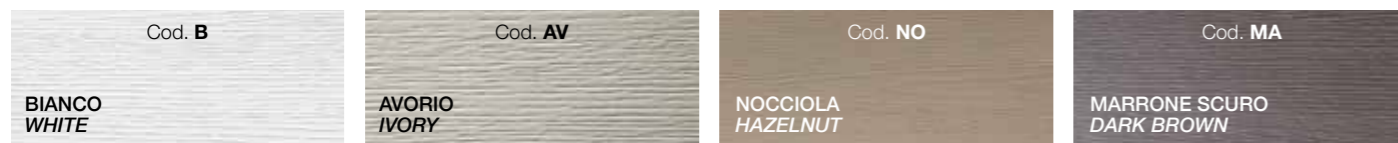

RETTANGOLARE RECTANGULAR

Cod.	Dimensioni Sizes	Kg	Bianco White	Colorati Colored
PDML7290H30	720x900 h 30 mm	22	€ 350,00	€ 360,00
PDML70100H30	700X1000 h 30 mm	28	€ 372,00	€ 383,00
PDML70120H30	700X1200 h 30 mm	32	€ 427,00	€ 438,00
PDML70140H30	700X1400 h 30 mm	35	€ 477,00	€ 493,00
PDML80100H30	800X1000 h 30 mm	29	€ 416,00	€ 427,00
PDML80120H30	800X1200 h 30 mm	33	€ 477,00	€ 488,00
PDML80140H30	800X1400 h 30 mm	36	€ 527,00	€ 538,00



Dettaglio del grigliato sottostante del piatto doccia in marmo resina H 40 mm.

Detail of the gridded underside of the marble-resin shower trays H40 mm.



SPECIFICHE TECNICHE TECHNICAL DETAILS



pulizia facile
easy clean



facile al taglio
easy to cut

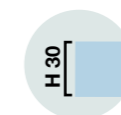

minimo spessore
minimum thickness



texture antiscivolo
textures non-slip



resistenza agli urti
resistance shock



piacevole al tatto
pleasant to the touch

NB: disponibile il kit per il ripristino dei piatti doccia
NOTE: available repair kit for the shower trays recovering

TAGLIO AL CM Custom cutting

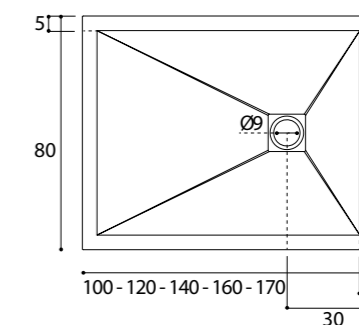
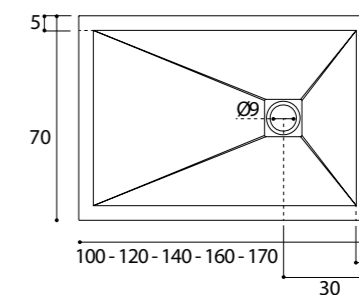
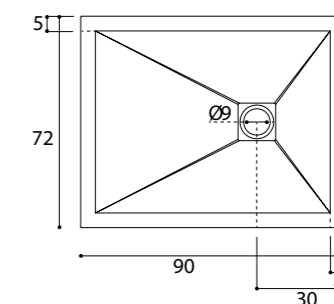

Piletta di scarico e copertura in acciaio inox inclusa
Siphon and stainless steel drain cover included



Cod. 700011
€ 18,00

PIATTO DOCCIA **H3**
SHOWER TRAY

ACRILICO H3

Piatti doccia / Shower trays

Piacere a pelle, questa è la sensazione che l'acrilico esprime una volta venuti a contatto con lui. Grazie al suo impiego nel settore bagno, Colacril ha utilizzato l'acrilico per la produzione di una vasta gamma di piatti doccia. la percezione del tatto viene rispettata, anzi viene esaltata dalla superficie liscia dell'acrilico con l'antiscivolo integrato e dalla nuova finitura Velvet che esprime la sua morbidezza e la delicatezza quando, dopo una giornata faticosa, si entra in doccia e ci si rilassa.

ACRYLIC SHOWER TRAYS

Pleasant to the touch, this is what one feels when comes into contact with the acrylic surface. In its dedication to the bathroom environment, Colacril has manufactured a variety of shower trays using acrylic. The perception of touch is highlighted by the smooth acrylic surface integrated with the anti-slip finish and the new velvet finish which offers a delicate softness when, after a long tiring day one takes a shower in order to relax.

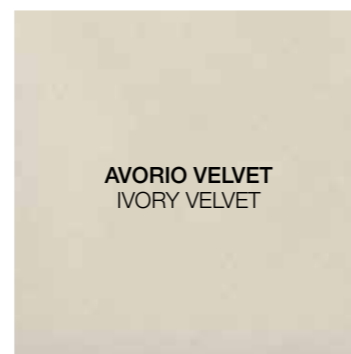
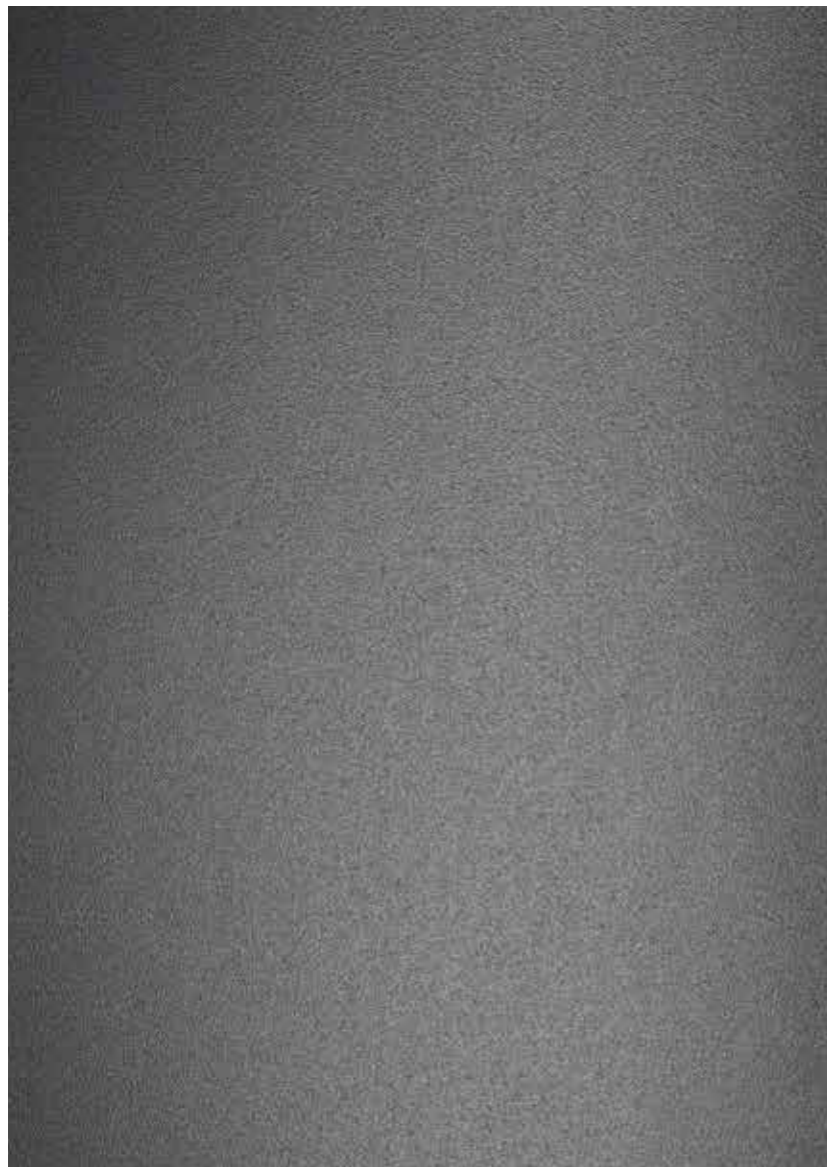

pulizia facile
easy clean



superficie antibatterica
antibacterial surface



minimo spessore
minimum thickness



texture antiscivolo
non-slip texture



scorrimento veloce acqua
fast water flow



piacevole al tatto
pleasant to the touch

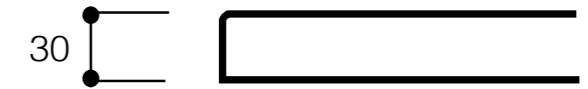

ACRILICO - H 30 mm

piatti doccia in acrilico / acrylic shower trays

Specificare sempre la finitura all'ordine.
Always specify the finish when placing the order.



Finiture Piatti Doccia / Shower Tray Finishes

FINITURE VELVET / VELVET FINISHES



bianco lucido
glossy white

Cod. **B**



bianco velvet
white velvet

Cod. **A**



avorio velvet
ivory velvet

Cod. **AV**



nero velvet
black velvet

Cod. **NE**



grigio chiaro velvet
light grey velvet

Cod. **GC**

QUADRATO SQUARE



Cod.	Dimensioni Sizes	Kg	Bianco lucido Glossy white	Finiture Velvet Velvet finishes
PDA8080H3	800X800	6,5	€ 222,00	€ 245,00
PDA9090H3	900X900	8	€ 241,00	€ 274,00
PDA100100H3	1000x1000	10	€ 261,00	€ 301,00

RETTANGOLARE RECTANGULAR

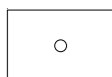

Cod.	Dimensioni Sizes	Kg	Bianco lucido Glossy white	Finiture Velvet Velvet finishes
PDA7290H3	720X900	8	€ 231,00	€ 256,00
PDA70100H3	700X1000	8,5	€ 231,00	€ 260,00
PDA70120H3	700X1200	9,5	€ 240,00	€ 273,00
PDA70140H3	700X1400	10,5	€ 256,00	€ 295,00
PDA70160H3	700X1600	11,5	€ 293,00	€ 337,00
PDA70170H3	700X1700	12,5	€ 325,00	€ 373,00
PDA80100H3	800X1000	9	€ 241,00	€ 276,00
PDA80120H3	800X1200	11	€ 273,00	€ 312,00
PDA80140H3	800X1400	15	€ 294,00	€ 339,00
PDA80160H3	800X1600	17	€ 325,00	€ 376,00
PDA80170H3	800X1700	18	€ 359,00	€ 414,00

SEMICIRCOLARE SEMICIRCULAR

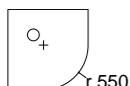

Cod.	Dimensioni Sizes	Kg	Bianco lucido Glossy white	Finiture Velvet Velvet finishes
PDSA8080H3	800X800	6	€ 220,00	€ 245,00
PDSA9090H3	900X900	8	€ 241,00	€ 274,00
PDSA100100H3	1000X1000	10	€ 261,00	€ 301,00

SPECIFICHE TECNICHE TECHNICAL DETAILS



pulizia
facile
easy clean



superficie
antibatterica
antibacterial
surface

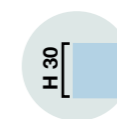

minimo
spessore
minimum
thickness



texture
antiscivolo
non-slip
texture



scorrimento
veloce acqua
fast water
flow



piacevole
al tatto
pleasant
to the touch

RINFORZO DEL LEGNO E VETRORESINA WOOD AND FIBREGLASS REINFORCEMENT

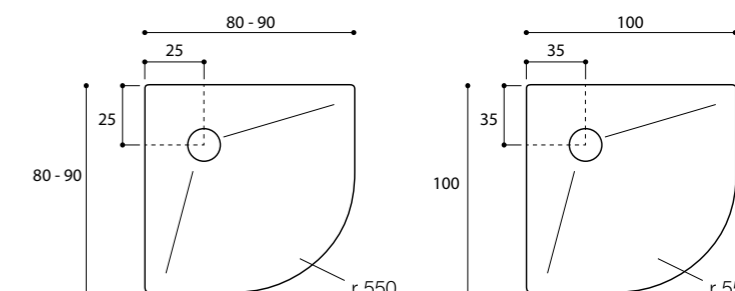
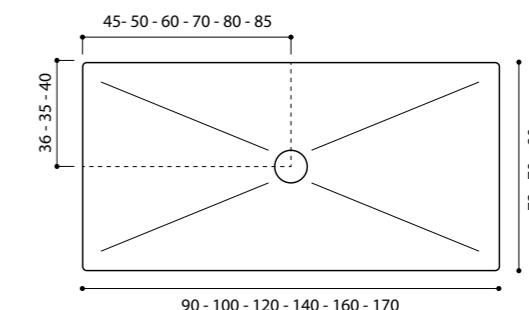
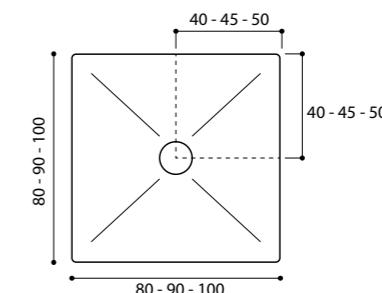

piletta di scarico inclusa Ø90
Siphon included Ø90



Cod. **700000**
€ 35,00

— 60 mm —

PIATTO DOCCIA **H5/BORDO**
SHOWER TRAY

ACRILICO H5/BORDO

Piatti doccia / Shower trays

Piacere a pelle, questa è la sensazione che l'acrilico esprime una volta venuti a contatto con lui. Grazie al suo impiego nel settore bagno, Colacril ha utilizzato l'acrilico per la produzione di una vasta gamma di piatti doccia. la percezione del tatto viene rispettata, anzi viene esaltata dalla superficie liscia dell'acrilico con l'antiscivolo integrato e dalla nuova finitura Velvet che esprime la sua morbidezza e la delicatezza quando, dopo una giornata faticosa, si entra in doccia e ci si rilassa.

ACRYLIC SHOWER TRAYS

Pleasant to the touch, this is what one feels when comes into contact with the acrylic surface. In its dedication to the bathroom environment, Colacril has manufactured a variety of shower trays using acrylic. The perception of touch is highlighted by the smooth acrylic surface integrated with the anti-slip finish and the new velvet finish which offers a delicate softness when, after a long tiring day one takes a shower in order to relax.

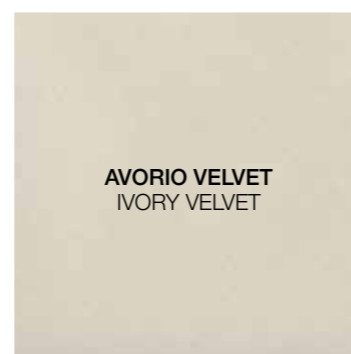
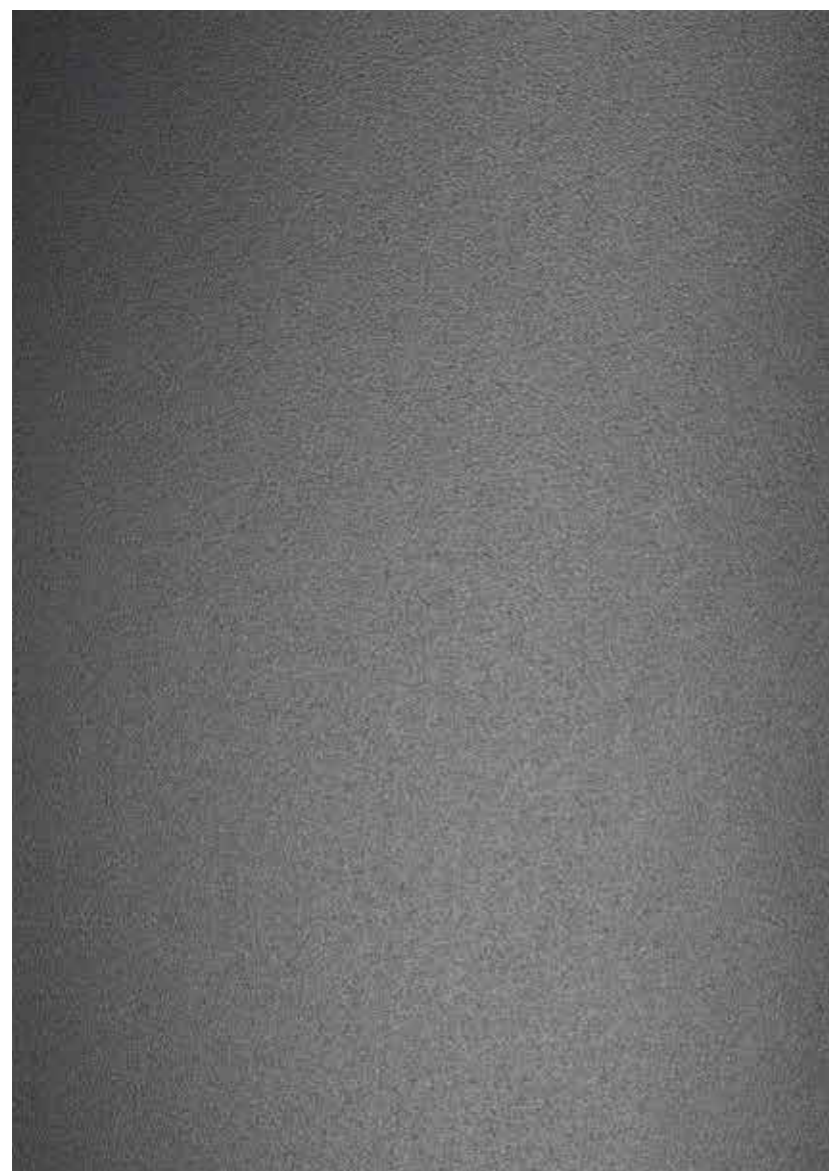

ACRILICO - H 50 mm

piatti doccia in acrilico / acrylic shower trays

Specificare sempre la finitura all'ordine.
Always specify the finish when placing the order.



Finiture Piatti Doccia / Shower Tray Finishes

FINITURE VELVET / VELVET FINISHES



bianco lucido
glossy white

Cod. **B**



bianco velvet
white velvet

Cod. **A**



avorio velvet
ivory velvet

Cod. **AV**



nero velvet
black velvet

Cod. **NE**



grigio chiaro velvet
light grey velvet

Cod. **GC**

QUADRATO SQUARE



Cod.	Dimensioni Sizes	Kg	Bianco lucido Glossy white	Finiture Velvet Velvet finishes
PDA8080H5	800X800	8,5	€ 222,00	€ 245,00
PDA9090H5	900X900	10	€ 241,00	€ 274,00
PDA100100H5	1000x1000	12	€ 261,00	€ 301,00

RETTANGOLARE RECTANGULAR



Cod.	Dimensioni Sizes	Kg	Bianco lucido Glossy white	Finiture Velvet Velvet finishes
PDA7290H5	720X900	10	€ 231,00	€ 256,00
PDA70100H5	700X1000	10,5	€ 231,00	€ 256,00
PDA70120H5	700X1200	11,5	€ 240,00	€ 273,00
PDA70140H5	700X1400	12,5	€ 256,00	€ 295,00
PDA70160H5	700X1600	13,5	€ 293,00	€ 337,00
PDA70170H5	700X1700	14,5	€ 325,00	€ 373,00
PDA80100H5	800X1000	11	€ 241,00	€ 276,00
PDA80120H5	800X1200	13	€ 273,00	€ 312,00
PDA80140H5	800X1400	17	€ 294,00	€ 339,00
PDA80160H5	800X1600	19	€ 325,00	€ 376,00
PDA80170H5	800X1700	20	€ 359,00	€ 414,00

SPECIFICHE TECNICHE TECHNICAL DETAILS



pulizia
facile
easy clean



superficie
antibatterica
antibacterial
surface

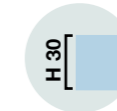

minimo
spessore
minimum
thickness



texture
antiscivolo
non-slip
texture



scorrimento
veloce acqua
fast water
flow



piacevole
al tatto
pleasant
to the touch

RINFORZO DEL LEGNO E VETRORESINA WOOD AND FIBREGLASS REINFORCEMENT

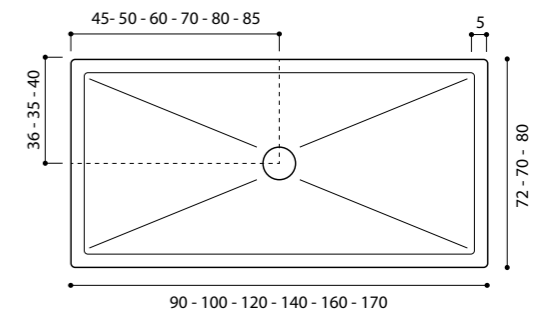
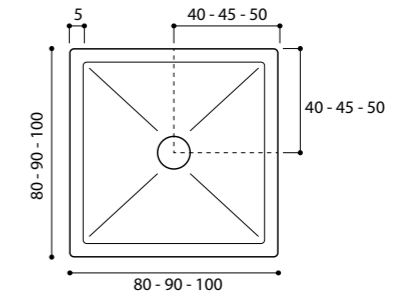
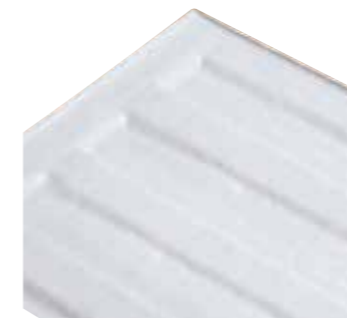

piletta di scarico inclusa Ø90
Siphon included Ø90



Cod. **700000**
€ 35,00

Un bordo perimetrale contenitivo corre lungo tutto il perimetro, disegnando un piatto doccia dal disegno tradizionale e per questo adatto anche in quelle situazioni in cui si vuole un abbinamento classico o in una sostituzione o integrazione. Questo modello in acrilico toglie qualsiasi indecisione legata alla paura di fuoriuscita dell'acqua ed è disponibile nei formati quadrato e rettangolare di colore Bianco Lucido.

A containing border runs along the entire shower tray perimeter, traditional design shower tray also suitable for those situations where a classic combination or replacement/integration installation is required. This acrylic shower tray offers water-tight installation. Available in glossy white finish, in both the rectangular and square shapes.







PANNELLI DI RIVESTIMENTO
WALL COVERING PANELS

Finiture pannelli / Wall panel finishes

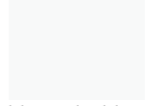
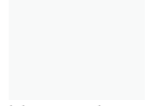
FINITURE VELVET / VELVET FINISHES

				
bianco lucido <i>glossy white</i>	bianco velvet <i>white velvet</i>	avorio velvet <i>ivory velvet</i>	nero velvet <i>black velvet</i>	grigio chiaro velvet <i>light grey velvet</i>

PANNELLI DI RIVESTIMENTO

WALLCOVERING PANELS

Pannelli in acrilico 6 mm

Incollaggio a parete con normale silicone antimuffa oppure utilizzando i tasselli in dotazione

Facile adattabilità

Profilo di chiusura taglio in dotazione

Abbinabili con qualsiasi piatto doccia in acrilico

6 mm acrylic panels

Wall bonding with normal antimould silicone or by using the included dowels

Easy adaptability

Closing cutting profile supplied

Matched with any acrylic shower tray

Spessore pannello **6 mm**
Panel tickness **6 mm**

Specificare sempre la finitura all'ordine.
Always specify the finish when placing the order.

Finiture Pannelli / Panels Finishes

FINITURE VELVET / VELVET FINISHES

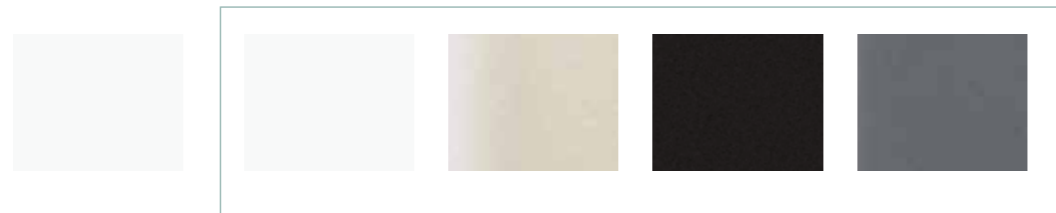

bianco lucido
glossy white

Cod. **B**

bianco velvet
white velvet

Cod. **BV**

avorio velvet
ivory velvet

Cod. **AV**

nero velvet
black velvet

Cod. **NE**

grigio chiaro velvet
light grey velvet

Cod. **GC**

Cod.	Dimensioni Sizes	Bianco lucido Glossy white	Finiture Velvet Velvet finishes
RA7080	700X800	€ 104,00	€ 120,00
RA9080	900X800	€ 116,00	€ 140,00
RA70200	700X2000	€ 200,00	€ 240,00
RA90200	900X2000	€ 240,00	€ 296,00



pulizia facile
easy clean



superficie antibatterica
antibacterial surface

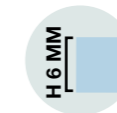

minimo spessore
minimum thickness



texture antiscivolo
non-slip texture



scorrimento veloce acqua
fast water flow



piacevole al tatto
pleasant to the touch



PRIMA
before



DOPO
after



INDICE TIPOLOGIA BOX DOCCIA 8mm

INDEX OF 8MM TYPE SHOWER ENCLOSURE

Porta Scorrevole / Sliding Door



Porta Battente / Hinge Door

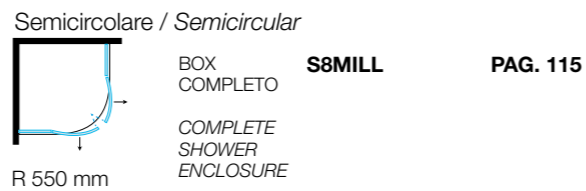
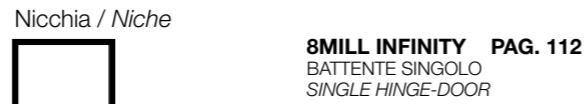

Soluzioni Aperte / Open Solutions

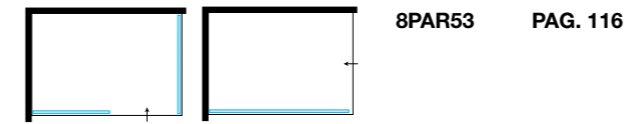

Lato fisso per soluzioni angolari / Fixed panel for corner solutions

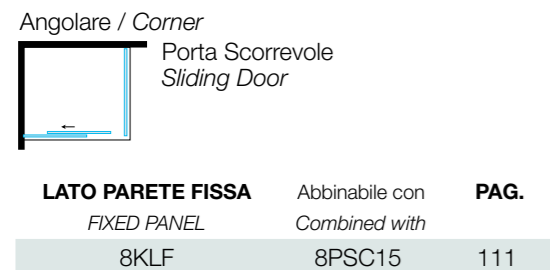

PORTA SCORREVOLE
SLIDING DOOR
8PSC15

PORTA BATTENTE
HINGE DOOR
8MILL INFINITY
BATTENTE SINGOLO
SINGLE HINGE-DOOR

8MILL INFINITY
DOPPIO BATTENTE
DOUBLE HINGE-DOOR

S8MILL INFINITY
SEMICIRCOLARE
SEMI-CIRCULAR

SOLUZIONI APERTE
OPEN SOLUTIONS
8PAR53
8PAR54

COLLEZIONI BOX DOCCIA 8 mm
8 MM SHOWER ENCLOSURE COLLECTION

8PSC15

Porta scorrevole / Sliding door

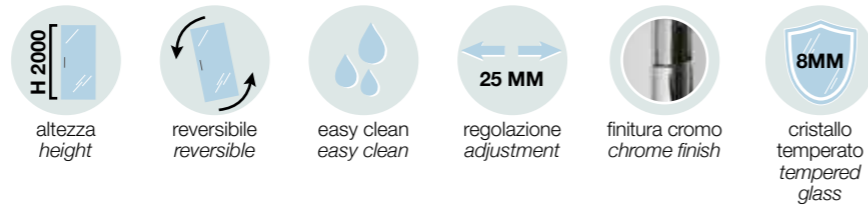

Cod. **NTPA06**
 Profilo di allungamento
 Adjustable profile
 + 15 mm
 € 36,00

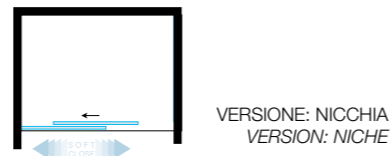

Box doccia completo / Complete shower enclosure

Cod.	PD mm	mm	Apertura mm Opening mm	Kg	Cristallo trasparente Transparent glass 8 mm
8PSC01510010N	1000	970 ↔ 995	400	51	€ 680,00
8PSC01511010N	1100	1070 ↔ 1095	450	56	€ 700,00
8PSC01512010N	1200	1170 ↔ 1195	500	61	€ 711,00
8PSC01513010N	1300	1270 ↔ 1295	550	66	€ 727,00
8PSC01514010N	1400	1370 ↔ 1395	600	71	€ 742,00
8PSC01515010N	1500	1470 ↔ 1495	650	76	€ 765,00
8PSC01516010N	1600	1570 ↔ 1595	700	81	€ 787,00
8PSC01517010N	1700	1670 ↔ 1695	700	86	€ 810,00
8PSC01518010N	1800	1770 ↔ 1795	700	91	€ 832,00

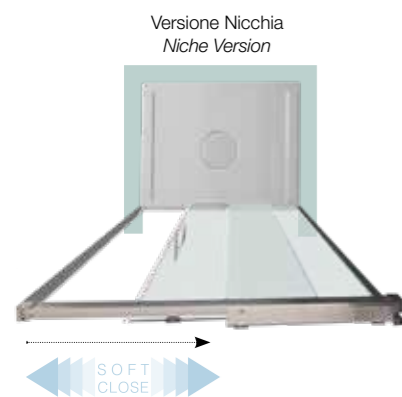

8PSC15 + 8KLF

Porta scorrevole + lato fisso / Sliding door + fixed side

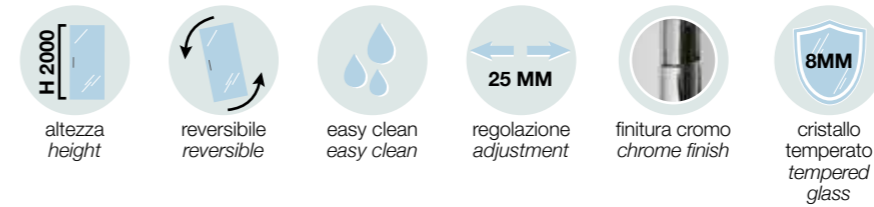

Cod. **NTPA06**
 Profilo di allungamento
 Adjustable profile
 + 15 mm
 € 36,00

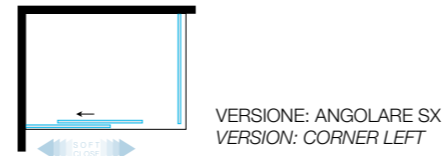

Lato porta scorrevole / Sliding door side

Cod.	PD mm	mm	Apertura mm Opening mm	Kg	Cristallo trasparente Transparent glass 8 mm
8PSC01510010	1000	970 ↔ 995	400	51	€ 580,00
8PSC01511010	1100	1070 ↔ 1095	450	56	€ 600,00
8PSC01512010	1200	1170 ↔ 1195	500	61	€ 611,00
8PSC01513010	1300	1270 ↔ 1295	550	66	€ 627,00
8PSC01514010	1400	1370 ↔ 1395	600	71	€ 642,00
8PSC01515010	1500	1470 ↔ 1495	650	76	€ 665,00
8PSC01516010	1600	1570 ↔ 1595	700	81	€ 687,00
8PSC01517010	1700	1670 ↔ 1695	700	86	€ 710,00
8PSC01518010	1800	1770 ↔ 1795	700	91	€ 732,00

8KLF - Lato parete fissa / Fixed side

8KLF70	700	680 ↔ 705	37	€ 351,00
8KLF80	800	770 ↔ 795	42	€ 367,00
8KLF90	900	870 ↔ 895	47	€ 383,00

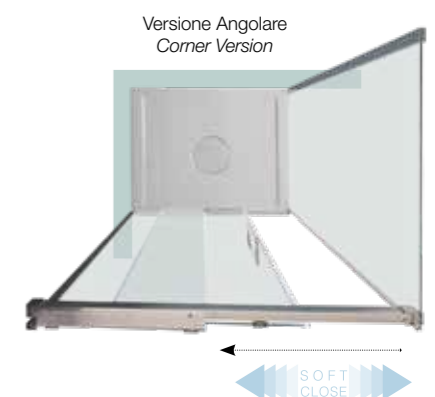

8MILL INFINITY

Porta battente / Hinge door



Cod. **NTPA07**
 Profilo di allungamento
 Adjustable profile
 + 20 mm
 € 47,00

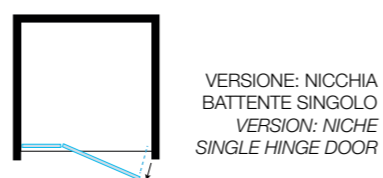

Box doccia completo / Complete shower enclosure

Cod.	PD mm	mm	Apertura mm Opening mm	Kg	Cristallo trasparente Transparent glass 8 mm
8MILLAP80N	800	787 ↔ 807	590	41	€ 768,00
8MILLAP90N	900	887 ↔ 907	590	45	€ 780,00
8MILLAP10N	1000	987 ↔ 1007	590	49	€ 805,00
8MILLAP11N	1100	1087 ↔ 1107	590	53	€ 818,00
8MILLAP12N	1200	1187 ↔ 1207	590	57	€ 830,00
8MILLAP13N	1300	1287 ↔ 1307	590	61	€ 844,00
8MILLAP14N	1400	1387 ↔ 1407	590	65	€ 861,00
8MILLAP15N	1500	1487 ↔ 1507	590	69	€ 877,00
8MILLAP16N	1600	1587 ↔ 1607	590	73	€ 905,00
8MILLAP17N	1700	1687 ↔ 1707	590	77	€ 923,00
8MILLAP18N	1800	1787 ↔ 1807	590	81	€ 939,00

Versione Nicchia
Niche Version

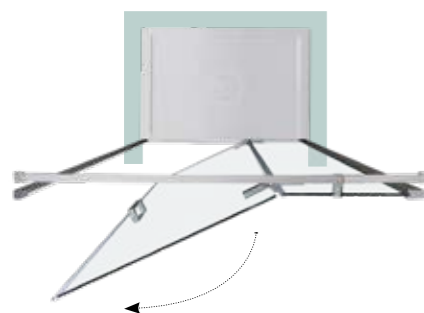

8MILL INFINITY

Porta doppio battente / Double hinge door

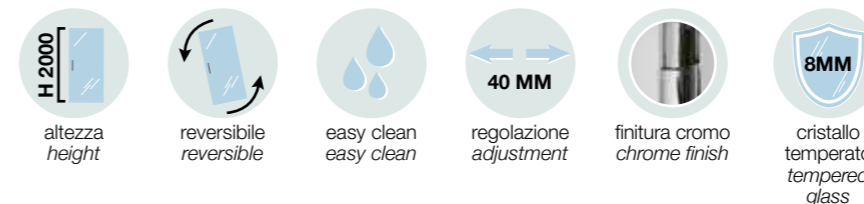

Cod. **NTPA07**
 Profilo di allungamento
 Adjustable profile
 + 20 mm
 € 47,00

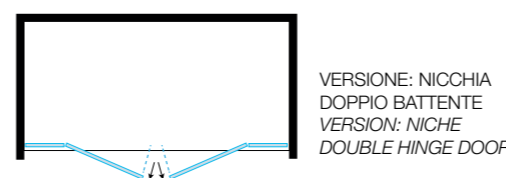

Box doccia completo / Complete shower enclosure

Cod.	PD mm	mm	Apertura mm Opening mm	Kg	Cristallo trasparente Transparent glass 8 mm
8MILLAP1A12N	1200	1168 ↔ 1208	840	63	A=200 P1=420+420 A=200 € 1.162,00
8MILLAP1A13N	1300	1268 ↔ 1308	840	67	A=200 P1=420+420 A=300 € 1.174,00
8MILLAP1A14N	1400	1368 ↔ 1408	840	71	A=300 P1=420+420 A=300 € 1.186,00
8MILLAP1A15N	1500	1468 ↔ 1508	840	75	A=300 P1=420+420 A=400 € 1.211,00
8MILLAP1A16N	1600	1568 ↔ 1608	840	79	A=400 P1=420+420 A=400 € 1.236,00
8MILLAP1A17N	1700	1668 ↔ 1708	840	83	A=400 P1=420+420 A=500 € 1.249,00
8MILLAP1A18N	1800	1768 ↔ 1808	840	87	A=500 P1=420+420 A=500 € 1.262,00
8MILLAP1A19N	1900	1868 ↔ 1908	840	91	A=500 P1=420+420 A=600 € 1.274,00
8MILLAP1A20N	2000	1968 ↔ 2008	840	95	A=600 P1=420+420 A=600 € 1.286,00

Versione Nicchia
Niche Version

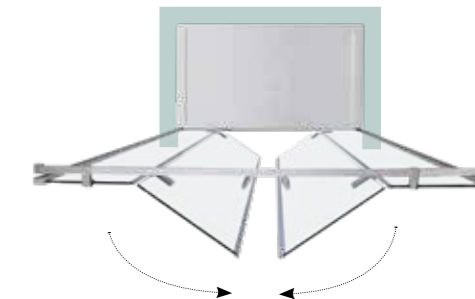

8MILL INFINITY + B8MILL

Porta battente + lato fisso / Hinge door + fixed side

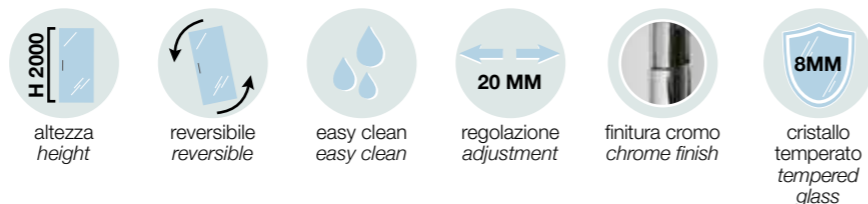

Cod. **NTPA07**
 Profilo di allungamento
 Adjustable profile
 + 20 mm
 € 47,00

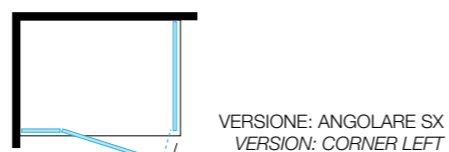

Lato porta battente / Hinge door side

Cod.	PD mm	mm	Apertura mm Opening mm	Kg	Cristallo trasparente Transparent glass 8 mm
8MILLAP80	800	762 ↔ 782	590	41	€ 705,00
8MILLAP90	900	862 ↔ 882	590	45	€ 717,00
8MILLAP10	1000	962 ↔ 982	590	49	€ 742,00
8MILLAP11	1100	1062 ↔ 1082	590	53	€ 755,00
8MILLAP12	1200	1162 ↔ 1182	590	57	€ 767,00
8MILLAP13	1300	1262 ↔ 1282	590	61	€ 781,00
8MILLAP14	1400	1362 ↔ 1382	590	65	€ 791,00
8MILLAP15	1500	1462 ↔ 1482	590	69	€ 814,00
8MILLAP16	1600	1562 ↔ 1582	590	73	€ 842,00
8MILLAP17	1700	1662 ↔ 1682	590	77	€ 860,00
8MILLAP18	1800	1762 ↔ 1782	590	81	€ 876,00

B8MILL - Lato parete fissa / Fixed side

B8MILLA70	700	670 ↔ 690	32	€ 232,00
B8MILLA80	800	770 ↔ 790	36	€ 244,00
B8MILLA90	900	870 ↔ 890	40	€ 256,00
B8MILLA100	1000	970 ↔ 990	44	€ 272,00



S8MILL INFINITY

Porta battente semicircolare / Semicircular hinge door

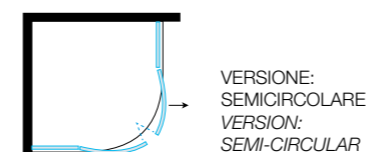
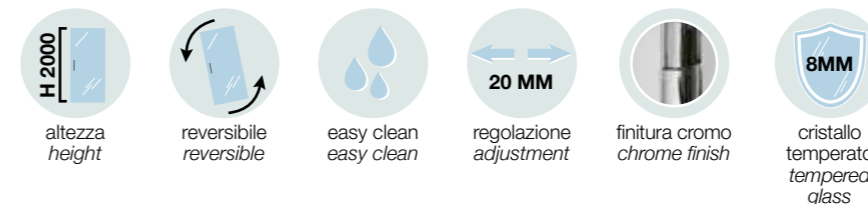

Cod. **NTPA07**
 Profilo di allungamento
 Adjustable profile
 + 20 mm
 € 47,00

Box doccia completo / Complete shower enclosure

Cod.	PD mm	mm	Apertura mm Opening mm	Kg	Cristallo trasparente Transparent glass 8 mm
S8MILL80	800	783 ↔ 798	730	61	€ 1.032,00
S8MILL90	900	883 ↔ 898	730	70	€ 1.053,00
S8MILL100	1000	983 ↔ 998	730	77	€ 1.080,00



8PAR53

Soluzioni aperte / Open solution

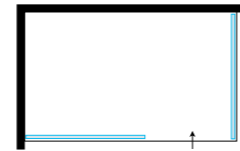
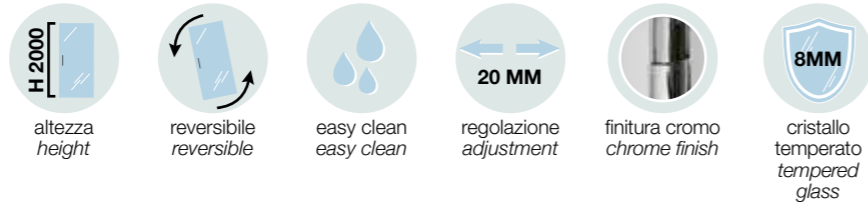

VERSIONE: WALK-IN
VERSION: WALK-IN



VERSIONE: ANGOLARE
VERSION: CORNER

Cod. **NTPA07**
Profilo di allungamento
Adjustable profile
+ 20 mm
€ 47,00

Singolo lato / Single side

Cod.	PD mm	mm	Kg	Cristallo trasparente Transparent glass 8 mm
8PAR05370010	700	680 ↔ 700	39	€ 352,00
8PAR05380010	800	780 ↔ 800	44	€ 366,00
8PAR05390010	900	880 ↔ 900	49	€ 383,00
8PAR05310010	1000	980 ↔ 1000	53	€ 410,00
8PAR05311010	1100	1080 ↔ 1100	58	€ 433,00
8PAR05312010	1200	1180 ↔ 1200	63	€ 455,00
8PAR05313010	1300	1280 ↔ 1300	68	€ 477,00
8PAR05314010	1400	1380 ↔ 1400	73	€ 549,00

(B) L'estensibilità dell'asta di fissaggio varia da 500 mm fino a 800 mm
(B) The extension of the support arm can vary from 500 mm to 800 mm

(C) L'estensibilità dell'asta di fissaggio varia da 710 mm fino a 1200 mm
(C) The extension of the support arm can vary from 710 mm to 1200 mm

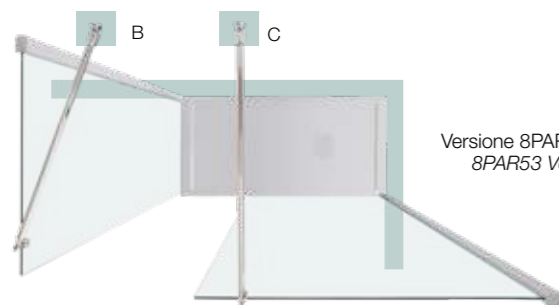

Versione 8PAR53 da 1100 mm + lato 8PAR53 da 700 mm
8PAR53 Version mm 1100 + side 8PAR53 mm 700

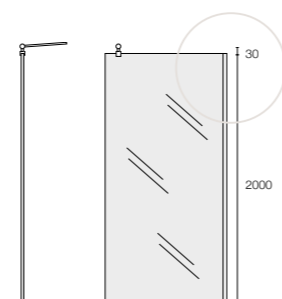

8PAR54

Soluzioni aperte / Open solution



VERSIONE: CENTRO PARETE
VERSION: CENTER WALL

Box doccia completo / Complete shower enclosure

Cod.	PD mm	Kg	Cristallo trasparente Transparent glass 8 mm
8PAR05410010	1000	53	€ 453,00
8PAR05411010	1100	58	€ 465,00
8PAR05412010	1200	63	€ 479,00
8PAR05413010	1300	68	€ 493,00
8PAR05414010	1400	73	€ 527,00
8PAR05415010	1500	78	€ 541,00
8PAR05416010	1600	83	€ 556,00

(C) L'estensibilità dell'asta di fissaggio varia da 710 mm fino a 1200 mm
(C) The extension of the support arm can vary from 710 mm to 1200 mm



Versione Centro Parete
Center Wall Version

INDICE TIPOLOGIA BOX DOCCIA 6mm EASY CLEAN H 2000 mm

INDEX OF 6MM TYPE SHOWER ENCLOSURE

Porta Scorrevole / Sliding Door

Nicchia / Niche



6PSC15 PAG. 120
TPSC55 PAG. 122
FPSC50 PAG. 124

Nicchia / Niche



FPSC57 PAG. 126

Angolare / Corner

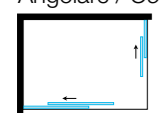

BOX COMPLETO **FLEX** PAG. 128
COMPLETE SHOWER ENCLOSURE

Semicircolare / Semicircular

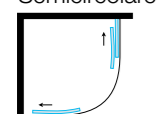

BOX COMPLETO **FS40 - R550** PAG. 130
FS40 - R380 PAG. 131
COMPLETE SHOWER ENCLOSURE
 R 380 mm
 R 550 mm

Porta Battente / Hinge Door

Nicchia / Niche



TEPB42 PAG. 132
TPB20 PAG. 133

Nicchia / Niche



TPB72 PAG. 136
TEPB43 PAG. 138

Angolare / Corner



BOX COMPLETO **TB71** PAG. 140
COMPLETE SHOWER ENCLOSURE

Angolare / Corner

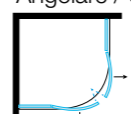

BOX COMPLETO **TB61** PAG. 141
COMPLETE SHOWER ENCLOSURE
 R 550 mm

Nicchia / Niche

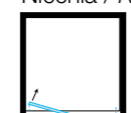

FPB40 PAG. 142
 700 mm
 800 mm
 900 mm

Nicchia / Niche

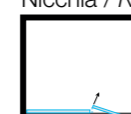

FPB40 PAG. 143
 1000 mm
 1100 mm
 1200 mm

Porta a Soffietto / Folding Door

Nicchia / Niche



TPS35 PAG. 146

Nicchia / Niche



FPS30 PAG. 148

Porta Saloon / Saloon door

Nicchia / Niche



FPSL60 PAG. 150

Soluzioni Aperte / Open Solutions

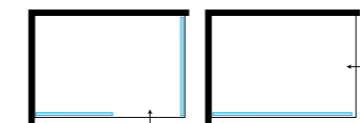

6PAR53 PAG. 152

Lato fisso per soluzioni angolare e centroparete / Fixed panel for corner and centre wall solutions

Angolare / Corner



Porta Scorrevole
 Sliding Door

LATO PARETE FISSA FIXED PANEL	Abbinabile con Combined with	PAG.
6KLF	+ 6PSC15	121
TALF	+ TPSC55	123
FISSO	+ FPSC50	125
FISSO	+ FPSC57	127
FISSO	+ FLEX	128

Angolare / Corner



Porta Battente
 Hinge Door

LATO PARETE FISSA FIXED PANEL	Abbinabile con Combined with	PAG.
TELF	+ TEPB42	134
TBLF	+ TPB72	137
TELF	+ TEPB43	139
FISSO	+ FPB40	144-145

Angolare / Corner

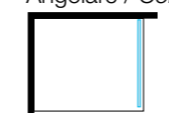

Porta a Soffietto e Porta Saloon
 Folding Door and Saloon Door

LATO PARETE FISSA FIXED PANEL	Abbinabile con Combined with	PAG.
TELF	+ TPS35	147
FISSO	+ FPS30	149
FISSO	+ FPSL60	151

Soprasvasca / Bathtub shower panel



TSV51 PAG. 153



TSV52 PAG. 153

PORTA SCORREVOLE
 SLIDING DOOR
6PSC15
TPSC55
FPSC50
FPSC57
FLEZ
FS40

PORTA BATTENTE
 HINGE DOOR
TEPB42
TPB20
TEPB43
TPB72
TB71
TB61
FPB40

PORTA A SOFFIETTO
 FOLDING DOOR
TPS35
FPS30

PORTA SALOON
 SALOON DOOR
FPSL60

SOLUZIONI APERTE
 OPEN SOLUTIONS
6PAR53

SOPRAVASCA
 BATHTUB SHOWER PANEL
TSV51
TSV52

6PSC15

Porta scorrevole / Sliding door



Cod. **NTTPA06**
 Profilo di allungamento
 Adjustable profile
 + 15 mm
 € 36,00

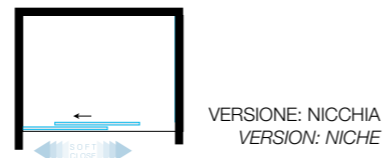

Box doccia completo / Complete shower enclosure

Cod.	PD mm	mm	Apertura mm Opening mm	Kg	Cristallo trasparente Transparent glass 6 mm
6PSC01510010N	1000	970 ↔ 995	400	36	€ 626,00
6PSC01511010N	1100	1070 ↔ 1095	450	39	€ 638,00
6PSC01512010N	1200	1170 ↔ 1195	500	42	€ 648,00
6PSC01513010N	1300	1270 ↔ 1295	550	45	€ 658,00
6PSC01514010N	1400	1370 ↔ 1395	600	48	€ 669,00
6PSC01515010N	1500	1470 ↔ 1495	650	51	€ 683,00
6PSC01516010N	1600	1570 ↔ 1595	700	54	€ 697,00
6PSC01517010N	1700	1670 ↔ 1695	700	57	€ 713,00
6PSC01518010N	1800	1770 ↔ 1795	700	60	€ 724,00

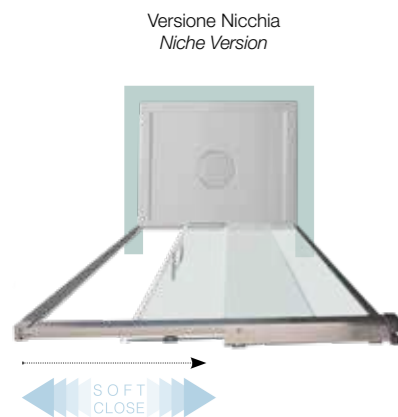

6PSC15 + 6KLF

Porta scorrevole + lato fisso / Sliding door + fixed side

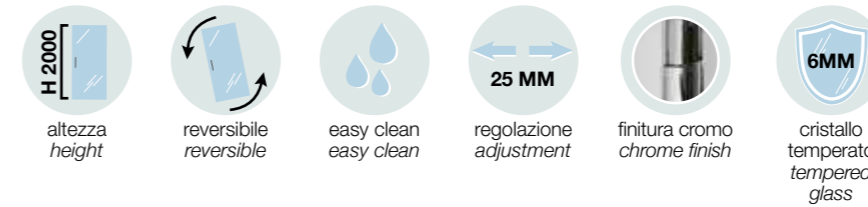

Cod. **NTTPA06**
 Profilo di allungamento
 Adjustable profile
 + 15 mm
 € 36,00



Lato porta scorrevole / Sliding door side

Cod.	PD mm	mm	Apertura mm Opening mm	Kg	Cristallo trasparente Transparent glass 6 mm
6PSC01510010	1000	970 ↔ 995	400	36	€ 532,00
6PSC01511010	1100	1070 ↔ 1095	450	39	€ 544,00
6PSC01512010	1200	1170 ↔ 1195	500	42	€ 554,00
6PSC01513010	1300	1270 ↔ 1295	550	45	€ 564,00
6PSC01514010	1400	1370 ↔ 1395	600	48	€ 575,00
6PSC01515010	1500	1470 ↔ 1495	650	51	€ 588,00
6PSC01516010	1600	1570 ↔ 1595	700	54	€ 603,00
6PSC01517010	1700	1670 ↔ 1695	700	57	€ 619,00
6PSC01518010	1800	1770 ↔ 1795	700	60	€ 629,00

6KLF - Lato parete fissa / Fixed side

6KLF70	700	680 ↔ 705	25	€ 330,00
6KLF80	800	770 ↔ 795	27	€ 341,00
6KLF90	900	870 ↔ 895	29	€ 352,00

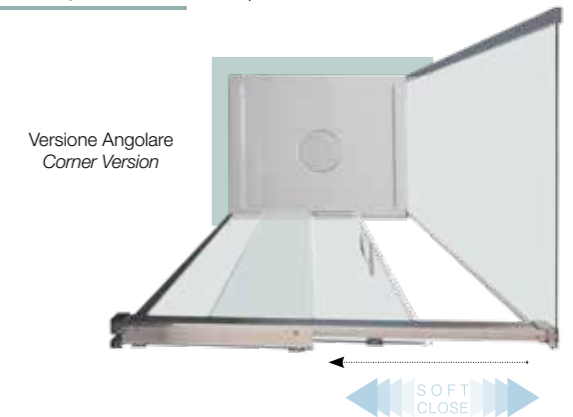

TPSC55

Porta scorrevole / Sliding door

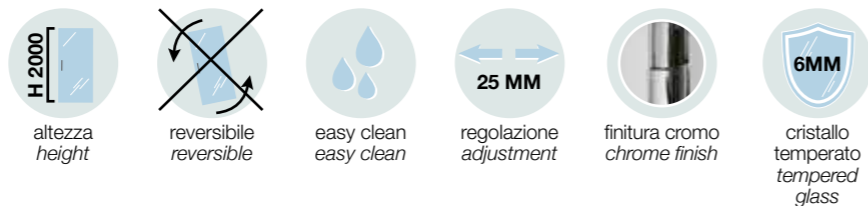

APERTURA SX / LEFT OPENING

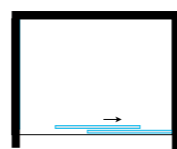

APERTURA DX
RIGHT OPENING
VERSIONE: NICCHIA
VERSION: NICHE



Box doccia completo / Complete shower enclosure

Cod.	DX o SX Right or left	PD mm	mm	Apertura mm Opening mm	Kg	Cristallo trasparente Transparent glass 6 mm
TPSC05510110	DX					
TPSC05510210	SX	1000	965 ↔ 1015	380	32	€ 464,00
TPSC05511110	DX					
TPSC05511210	SX	1100	1065 ↔ 1115	430	35	€ 475,00
TPSC05512110	DX					
TPSC05512210	SX	1200	1165 ↔ 1215	480	38	€ 490,00
TPSC05513110	DX					
TPSC05513210	SX	1300	1265 ↔ 1315	530	41	€ 502,00
TPSC05514110	DX					
TPSC05514210	SX	1400	1365 ↔ 1415	580	44	€ 515,00

Specificare sempre apertura DX o SX all'ordine
Specify always type of opening Right or Left when placing the order



Versione Nicchia
Niche Version

Apertura DX
Right opening door

TPSC55 + TALF

Porta scorrevole + lato fisso / Sliding door + fixed side

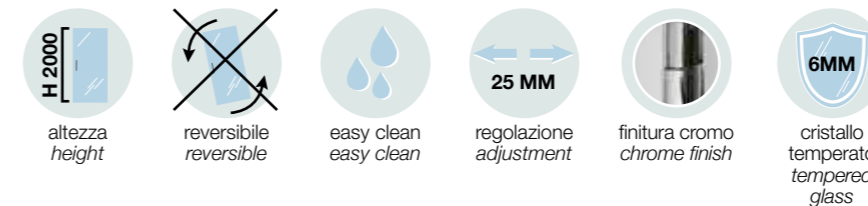

APERTURA DX / RIGHT OPENING

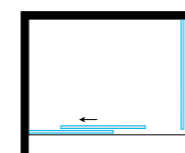

APERTURA SX
LEFT OPENING
VERSIONE: ANGOLARE
VERSION: CORNER

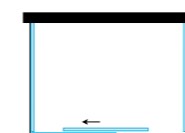

APERTURA SX
LEFT OPENING
VERSIONE: CENTRO PARETE
VERSION: CENTER WALL

Lato porta scorrevole / Sliding door side

Cod.	DX o SX Right or left	PD mm	mm	Apertura mm Opening mm	Kg	Cristallo trasparente Transparent glass 6 mm
TPSC05510110	DX					
TPSC05510210	SX	1000	965 ↔ 1015	380	32	€ 464,00
TPSC05511110	DX					
TPSC05511210	SX	1100	1065 ↔ 1115	430	35	€ 475,00
TPSC05512110	DX					
TPSC05512210	SX	1200	1165 ↔ 1215	480	38	€ 490,00
TPSC05513110	DX					
TPSC05513210	SX	1300	1265 ↔ 1315	530	41	€ 502,00
TPSC05514110	DX					
TPSC05514210	SX	1400	1365 ↔ 1415	580	44	€ 515,00

Specificare sempre apertura DX o SX all'ordine
Specify always type of opening Right or Left when placing the order

TALF - 2° e 3° Lato parete fissa / 2° and 3° Fixed side

TALF70	700	665 ↔ 690	25	€ 277,00
TALF80	800	765 ↔ 790	27	€ 290,00

Lato parete fissa utilizzabile sia per angolo DX che SX
Fixed side usable for both - Right and Left corner

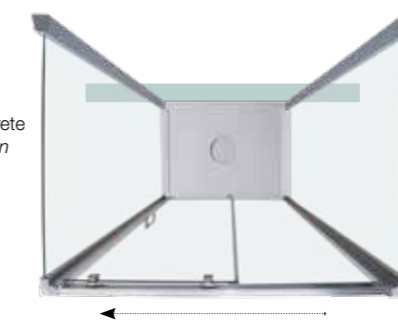

Versione Centro Parete
Center Wall Version

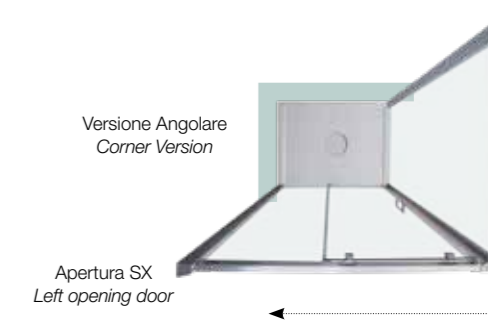

Versione Angolare
Corner Version

Apertura SX
Left opening door

FPSC50

Porta scorrevole / Sliding door

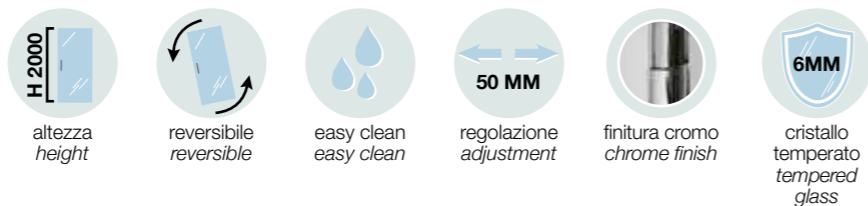

Cod. **TPAF08**
 Profilo di allungamento
 Adjustable profile
 + 30 mm
 € 47,00



Box doccia completo / Complete shower enclosure

Cod.	PD mm	mm	Apertura mm Opening mm	Kg	Cristallo		
					trasparente Transparent glass 6 mm	satinato Frosted glass 6 mm	cincillà Cincillà glass 6 mm
FPSC05010010	1000	950 ↔ 1000	370	41	€ 384,00	€ 430,00	€ 403,00
FPSC05011010	1100	1050 ↔ 1100	420	43	€ 393,00	€ 440,00	€ 413,00
FPSC05012010	1200	1150 ↔ 1200	470	45	€ 398,00	€ 447,00	€ 418,00
FPSC05013010	1300	1250 ↔ 1300	520	46	€ 406,00	€ 455,00	€ 426,00
FPSC05014010	1400	1350 ↔ 1400	570	47	€ 416,00	€ 463,00	€ 437,00
FPSC05015010	1500	1450 ↔ 1500	635	48	€ 467,00	€ 524,00	€ 490,00
FPSC05016010	1600	1550 ↔ 1600	685	50	€ 480,00	€ 537,00	€ 504,00
FPSC05017010	1700	1650 ↔ 1700	685	53	€ 493,00	€ 552,00	€ 518,00
FPSC05018010	1800	1750 ↔ 1800	685	56	€ 505,00	€ 566,00	€ 530,00

FPSC50 + FISSO

Porta scorrevole + lato fisso / Sliding door + fixed side



Cod. **TPAF08**
 Profilo di allungamento
 Adjustable profile
 + 30 mm
 € 47,00

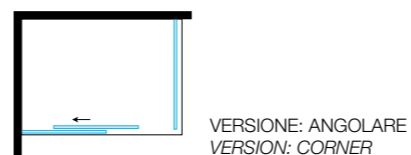

Lato porta scorrevole / Sliding door side

Cod.	PD mm	mm	Apertura mm Opening mm	Kg	Cristallo		
					trasparente Transparent glass 6 mm	satinato Frosted glass 6 mm	cincillà Cincillà glass 6 mm
FPSC05010010	1000	962 ↔ 1010	370	41	€ 384,00	€ 430,00	€ 403,00
FPSC05011010	1100	1062 ↔ 1110	420	43	€ 393,00	€ 440,00	€ 413,00
FPSC05012010	1200	1162 ↔ 1210	470	45	€ 398,00	€ 447,00	€ 418,00
FPSC05013010	1300	1262 ↔ 1310	520	46	€ 406,00	€ 455,00	€ 426,00
FPSC05014010	1400	1362 ↔ 1410	570	47	€ 416,00	€ 463,00	€ 437,00
FPSC05015010	1500	1462 ↔ 1510	635	48	€ 467,00	€ 524,00	€ 490,00
FPSC05016010	1600	1562 ↔ 1610	685	50	€ 480,00	€ 537,00	€ 504,00
FPSC05017010	1700	1662 ↔ 1710	685	53	€ 493,00	€ 552,00	€ 518,00
FPSC05018010	1800	1762 ↔ 1810	685	56	€ 505,00	€ 566,00	€ 530,00

FISSO - 2° e 3° Lato parete fissa / 2° and 3° Fixed side

FISSO70	700	665 ↔ 715	22	€ 295,00	€ 331,00	€ 310,00
FISSO80	800	765 ↔ 815	26	€ 301,00	€ 337,00	€ 316,00
FISSO90	900	865 ↔ 915	28	€ 310,00	€ 346,00	€ 326,00
FISSO100	1000	965 ↔ 1015	30	€ 317,00	€ 355,00	€ 334,00

Versione Nicchia
 Niche Version



Versione Angolare
 Corner Version

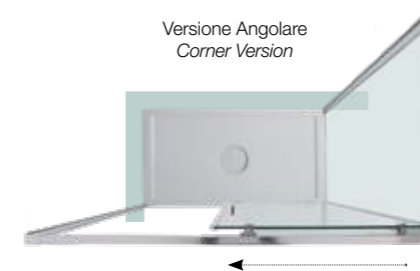

Versione Centro Parete
 Center Wall Version



FPSC57

Porta scorrevole / Sliding door

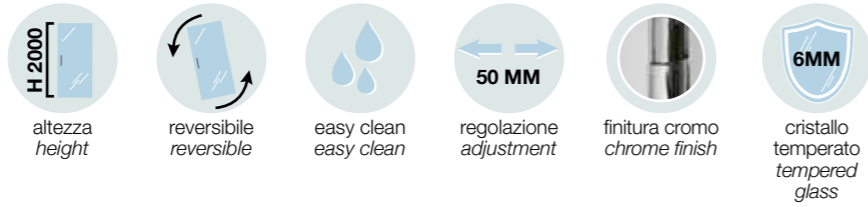

Cod. **TPAF08**
 Profilo di allungamento
 Adjustable profile
 + 30 mm
 € 47,00

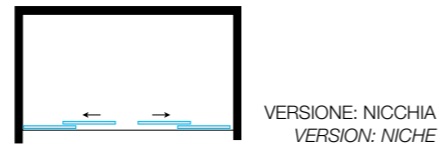

Box doccia completo / Complete shower enclosure

Cod.	PD mm	mm	Apertura mm Opening mm	Kg	Cristallo		
					trasparente Transparent glass 6 mm	satinato Frosted glass 6 mm	cincillà Cincillà glass 6 mm
FPSC05714010	1400	1350 ↔ 1400	515	45	€ 486,00	€ 545,00	€ 510,00
FPSC05715010	1500	1450 ↔ 1500	565	46	€ 498,00	€ 559,00	€ 523,00
FPSC05716010	1600	1550 ↔ 1600	615	48	€ 512,00	€ 573,00	€ 538,00
FPSC05717010	1700	1650 ↔ 1700	665	52	€ 524,00	€ 588,00	€ 550,00
FPSC05718010	1800	1750 ↔ 1800	715	53	€ 536,00	€ 601,00	€ 563,00

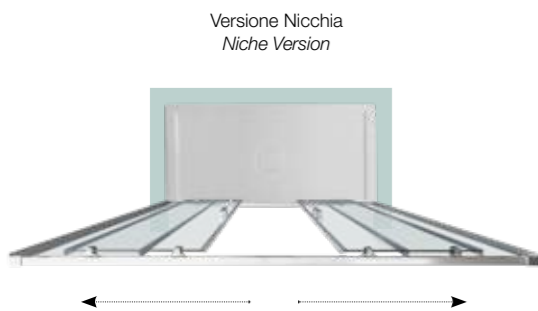

FPSC57 + FISSO

Porta scorrevole + lato fisso / Sliding door + fixed side

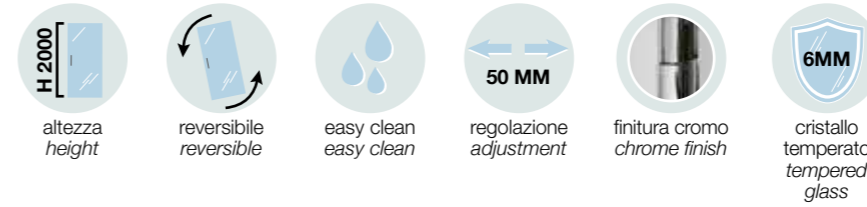

Cod. **TPAF08**
 Profilo di allungamento
 Adjustable profile
 + 30 mm
 € 47,00

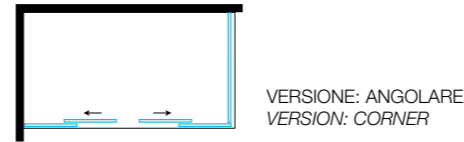

Lato porta scorrevole / Sliding door side

Cod.	PD mm	mm	Apertura mm Opening mm	Kg	Cristallo		
					trasparente Transparent glass 6 mm	satinato Frosted glass 6 mm	cincillà Cincillà glass 6 mm
FPSC05714010	1400	1362 ↔ 1410	515	45	€ 486,00	€ 545,00	€ 510,00
FPSC05715010	1500	1462 ↔ 1510	565	46	€ 498,00	€ 559,00	€ 523,00
FPSC05716010	1600	1562 ↔ 1610	615	48	€ 512,00	€ 573,00	€ 538,00
FPSC05717010	1700	1662 ↔ 1710	665	52	€ 524,00	€ 588,00	€ 550,00
FPSC05718010	1800	1762 ↔ 1810	715	53	€ 536,00	€ 601,00	€ 563,00

FISSO - 2° e 3° Lato parete fissa / 2° and 3° Fixed side

FISSO70	700	685 ↔ 715	22	€ 295,00	€ 331,00	€ 310,00
FISSO80	800	765 ↔ 815	26	€ 301,00	€ 337,00	€ 313,00
FISSO90	900	865 ↔ 915	28	€ 310,00	€ 346,00	€ 326,00
FISSO100	1000	965 ↔ 1015	30	€ 317,00	€ 355,00	€ 334,00

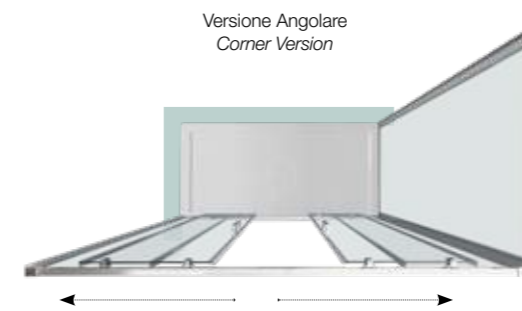

FLEX

Porta scorrevole / Sliding door



- altezza
height
- reversibile
reversible
- easy clean
easy clean
- 25 MM
regolazione
adjustment
- finitura cromo
chrome finish
- 6MM
cristallo temperato
tempered glass



RETTANGOLARE
RECTANGULAR

VERSIONE: ANGOLARE
VERSION: CORNER

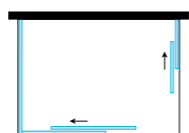

RETTANGOLARE
RECTANGULAR

VERSIONE: CENTRO PARETE
VERSION: CENTER WALL

Cod. **TPAF08**
Profilo di allungamento
Adjustable profile
+ 30 mm
€ 47,00



Lato porta scorrevole / Sliding door side

Cod.	PD mm	mm	Kg	Cristallo		
				trasparente Transparent glass 6 mm	satinato Frosted glass 6 mm	cincillà Cincillà glass 6 mm
FLEX70	700	665 ↔ 690	41	€ 230,00	€ 258,00	€ 241,00
FLEX72	720	685 ↔ 710	43	€ 233,00	€ 261,00	€ 245,00
FLEX75	750	715 ↔ 740	45	€ 238,00	€ 265,00	€ 250,00
FLEX80	800	765 ↔ 790	46	€ 243,00	€ 272,00	€ 255,00
FLEX90	900	865 ↔ 890	47	€ 250,00	€ 280,00	€ 262,00
FLEX100	1000	965 ↔ 990	48	€ 261,00	€ 292,00	€ 274,00
FLEX110	1100	1065 ↔ 1090	50	€ 275,00	€ 307,00	€ 289,00
FLEX120	1200	1165 ↔ 1190	53	€ 283,00	€ 317,00	€ 297,00
FLEX130	1300	1265 ↔ 1290	56	€ 303,00	€ 340,00	€ 319,00
FLEX140	1400	1365 ↔ 1390	56	€ 311,00	€ 349,00	€ 326,00

APERTURA PORTA OPENING DOOR

FLEX MM	700	720	750	800	900	1000	1100	1200	1300	1400
700	331	338	349	368	408	450	493	538	583	629
720	338	345	356	374	414	455	498	542	587	633
750	349	356	366	384	423	463	505	549	594	639
800	368	374	384	402	438	478	519	561	605	649
900	408	414	423	438	472	509	548	588	630	673
1000	450	455	463	478	509	543	580	618	658	699
1100	493	498	505	519	548	580	614	650	688	728
1200	538	542	549	561	588	618	650	685	721	759
1300	583	587	594	605	630	658	688	721	755	791
1400	629	633	639	649	673	699	728	759	791	826

FISSO - 3° Lato parete fissa / 3° Fixed side

FISSO70	700	665 ↔ 715	22	€ 295,00	€ 331,00	€ 310,00
FISSO80	800	765 ↔ 815	26	€ 301,00	€ 337,00	€ 316,00
FISSO90	900	865 ↔ 915	28	€ 310,00	€ 346,00	€ 326,00
FISSO100	1000	965 ↔ 1015	30	€ 317,00	€ 355,00	€ 334,00



FS40

Porta scorrevole / Sliding door



- altezza
height
- reversibile
reversible
- easy clean
easy clean
- 20 MM
regolazione
adjustment
- finitura cromo
chrome finish
- 6MM
cristallo
temperato
tempered
glass

Cod. **TPAF08**
Profilo di allungamento
Adjustable profile
+ 30 mm
€ 47,00



Box doccia semicircolare / Semicircular shower enclosure

Cod.	PD mm	mm	Apertura mm Opening mm	Kg	Cristallo		
					trasparente Trasparent glass 6 mm	satinato Frosted glass 6 mm	cincillà Cincillà glass 6 mm
FS04080010	800 x 800	765 ↔ 785 x 765 ↔ 785	440	44	€ 506,00	€ 567,00	€ 531,00
FS04090010	900 x 900	865 ↔ 885 x 865 ↔ 885	520	49	€ 517,00	€ 581,00	€ 543,00
FS04010010	1000 x 1000	965 ↔ 985 x 965 ↔ 985	520	54	€ 536,00	€ 602,00	€ 563,00

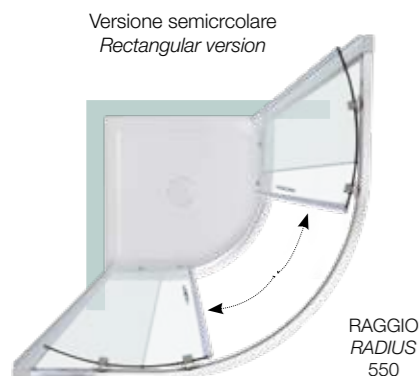

FS40

Porta scorrevole / Sliding door



- altezza
height
- reversibile
reversible
- easy clean
easy clean
- 20 MM
regolazione
adjustment
- finitura cromo
chrome finish
- 6MM
cristallo
temperato
tempered
glass

Cod. **TPAF08**
Profilo di allungamento
Adjustable profile
+ 30 mm
€ 47,00

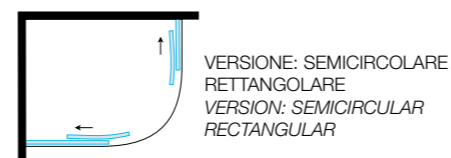

Box doccia semicircolare rettangolare / Semicircular rectangular shower enclosure

Cod.	PD mm	mm	Apertura mm Opening mm	Kg	Cristallo		
					trasparente Trasparent glass 6 mm	satinato Frosted glass 6 mm	cincillà Cincillà glass 6 mm
FS4072010	720 x 900	685 ↔ 705 x 865 ↔ 885	390	50	€ 536,00	€ 602,00	€ 563,00
FS4081010	800 x 1000	765 ↔ 785 x 965 ↔ 985	390	54	€ 552,00	€ 618,00	€ 580,00
FS4082010	800 x 1200	765 ↔ 785 x 1165 ↔ 1185	390	55	€ 668,00	€ 748,00	€ 702,00

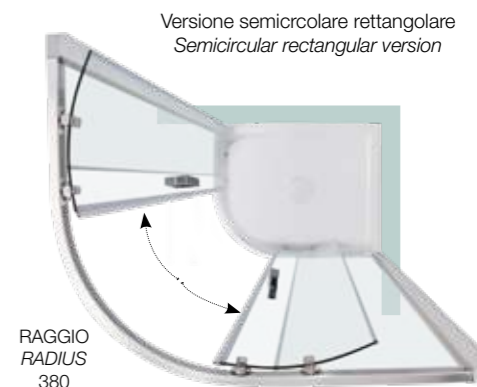

TEPB42

Porta battente / Hinge door

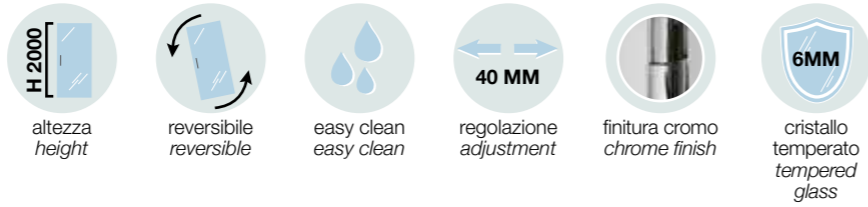

Cod. **NTPA01**
 Profilo di allungamento
 Adjustable profile
 + 30 mm
 € 47,00

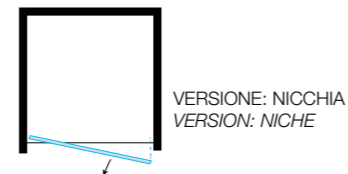

Box doccia completo / Complete shower enclosure

Cod.	PD mm	mm	Apertura mm Opening mm	Profilo Profile	Kg	Cristallo trasparente Transparent glass 6 mm
TEPB04265010NP	650	640 ↔ 665	600	NTCP01	24	€ 444,00
TEPB04270010NP	700	680 ↔ 705	600	NTCP03	24	€ 467,00
TEPB04265010N	700	680 ↔ 720	640	NTCP01	26	€ 473,00
TEPB04270010N	750	720 ↔ 760	640	NTCP03	26	€ 496,00
TEPB04280010NP	800	770 ↔ 795	730	NTCP01	28	€ 476,00
TEPB04280010N	850	810 ↔ 850	730	NTCP03	28	€ 505,00
TEPB04290010NP	900	870 ↔ 895	830	NTCP01	30	€ 486,00
TEPB04290010N	950	910 ↔ 950	830	NTCP03	30	€ 515,00



Cod. **S**
**Cristallo
 satinato**
 Frosted glass
 6 mm

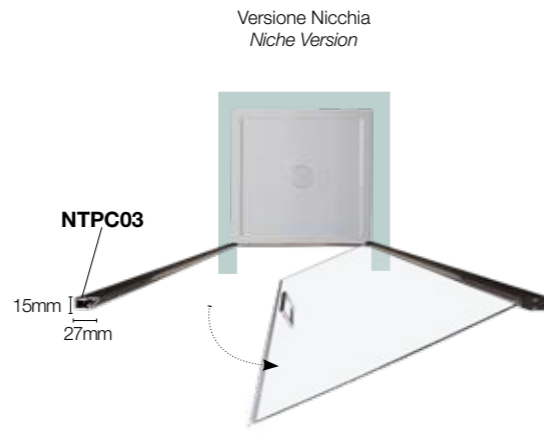
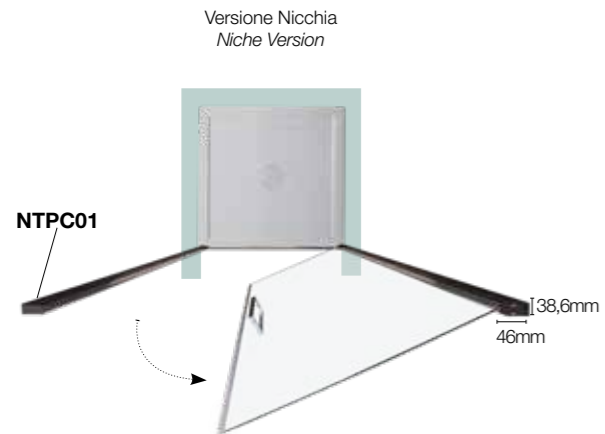

TPB20

Porta battente / Hinge door

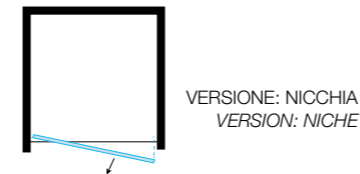
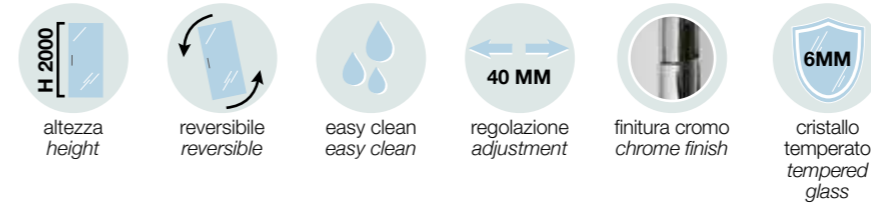

Box doccia completo / Complete shower enclosure

Cod.	PD mm	mm	Apertura mm Opening mm	Kg	Cristallo trasparente Transparent glass 6 mm	Cod. S Cristallo satinato Frosted glass 6 mm
TPB02070010	700	670 ↔ 710	560	25	€ 367,00	€ 410,00
TPB02080010	800	770 ↔ 810	660	28	€ 377,00	€ 422,00
TPB02090010	900	870 ↔ 910	760	31	€ 396,00	€ 444,00

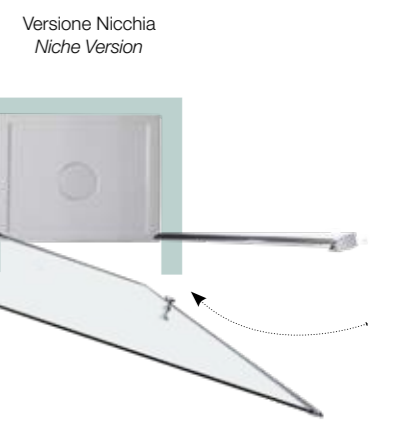

TEPB42 + TELF

Porta battente / Hinge door



Cod. **NTPA01**
 Profilo di allungamento
 Adjustable profile
 + 30 mm
 € 47,00

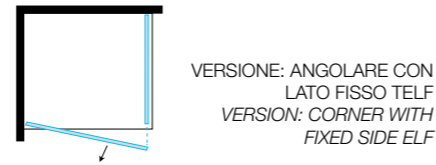

Lato porta battente / Hinge door side

Cod.	PD mm	mm	Apertura mm Opening mm	Kg	Cristallo trasparente Transparent glass 6 mm
TEPB04265010	650	640 ↔ 660	600	24	€ 391,00
TEPB04270010	700	680 ↔ 700	640	26	€ 414,00
TEPB04280010	800	770 ↔ 790	730	28	€ 423,00
TEPB04290010	900	870 ↔ 890	830	30	€ 433,00

TELF - 2 Lato parete fissa / 2 Fixed side

TELF70	700	680 ↔ 700	25	€ 286,00
TELF80	800	770 ↔ 790	27	€ 294,00
TELF90	900	870 ↔ 890	29	€ 303,00
TELF100	1000	970 ↔ 990	31	€ 313,00

Versione TEPB42 con lato fisso TELF
 TEPB42 with fixed side TELF version

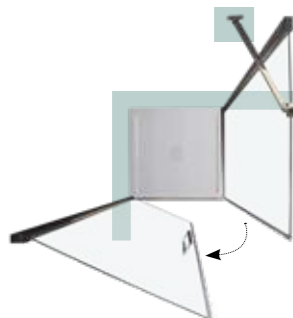

TEPB42 + TEPB42

Porta battente / Hinge door

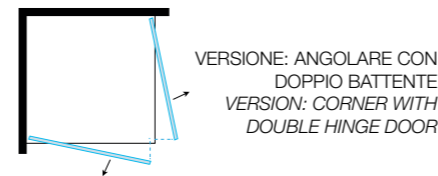
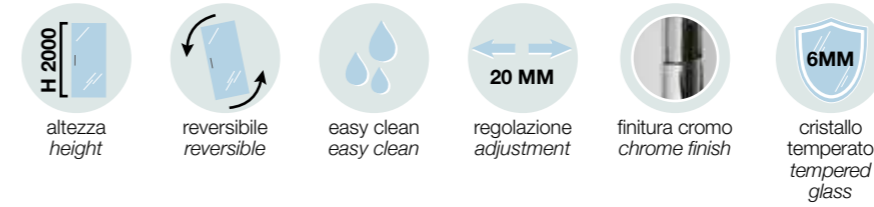

Singolo lato / Single side

Cod.	PD mm	mm	Kg	Cristallo trasparente Transparent glass 6 mm
TEPB04265010	650	640 ↔ 660	24	€ 391,00
TEPB04270010	700	680 ↔ 700	26	€ 414,00
TEPB04280010	800	770 ↔ 790	28	€ 423,00
TEPB04290010	900	870 ↔ 890	30	€ 433,00

Versione con doppia porta
 Version with double doors



TPB72

Porta scorrevole / Sliding door

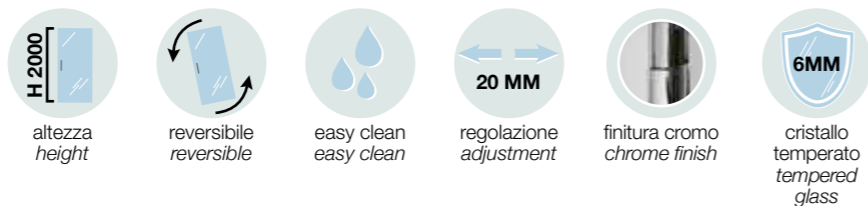

Cod. **NTPA05**
 Profilo di allungamento
 Adjustable profile
 + 25 mm
 € 47,00

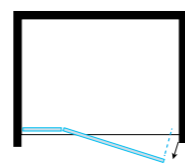

VERSIONE: NICCHIA
 VERSION: NICHE



Cod. **NTPA05**
 Profilo di allungamento
 Adjustable profile
 + 25 mm
 € 47,00

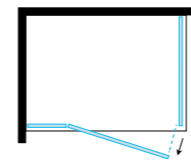

VERSIONE: ANGOLARE
 VERSION: CORNER

TPB72 + TBLF

Porta battente / Hinge door



Lato porta battente / Hinge door side

Cod.	PD mm	mm	Apertura mm Opening mm	Kg	Cristallo trasparente Transparent glass 6 mm
TPB07270010N	700	680 ↔ 700	450	27	€ 614,00
TPB07280010N	800	770 ↔ 790	450	29	€ 624,00
TPB07290010N	900	870 ↔ 890	590	34	€ 635,00
TPB07210010N	1000	970 ↔ 990	640	37	€ 646,00
TPB07211010N	1100	1070 ↔ 1090	640	40	€ 658,00
TPB07212010N	1200	1170 ↔ 1190	640	43	€ 669,00
TPB07213010N	1300	1270 ↔ 1290	640	46	€ 681,00
TPB07214010N	1400	1370 ↔ 1390	640	49	€ 695,00

Lato porta battente / Hinge door side

Cod.	PD mm	mm	Apertura mm Opening mm	Kg	Cristallo trasparente Transparent glass 6 mm
TPB07270010	700	680 ↔ 700	450	27	€ 561,00
TPB07280010	800	770 ↔ 790	450	29	€ 571,00
TPB07290010	900	870 ↔ 890	590	34	€ 582,00
TPB07210010	1000	970 ↔ 990	640	37	€ 593,00
TPB07211010	1100	1070 ↔ 1090	640	40	€ 605,00
TPB07212010	1200	1170 ↔ 1190	640	43	€ 616,00
TPB07213010	1300	1270 ↔ 1290	640	46	€ 628,00
TPB07214010	1400	1370 ↔ 1390	640	49	€ 642,00

TBLF - Lato parete fissa / Fixed side

TBLF70	700	680 ↔ 700	25	€ 291,00
TBLF80	800	770 ↔ 790	27	€ 302,00
TBLF90	900	870 ↔ 890	29	€ 313,00
TBLF100	1000	970 ↔ 990	31	€ 324,00

Versione nicchia
 Niche version

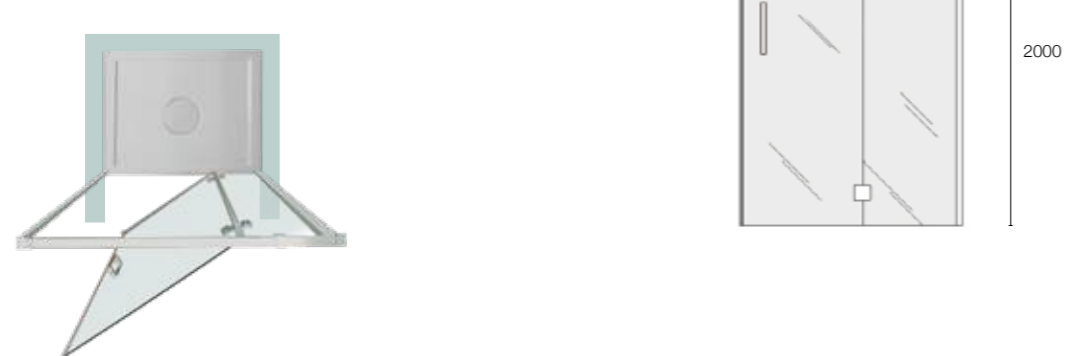

Versione Angolare
 Corner Version

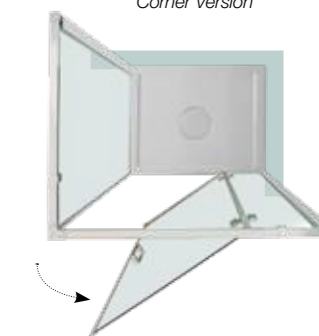

TEPB43

Porta battente / Hinge door

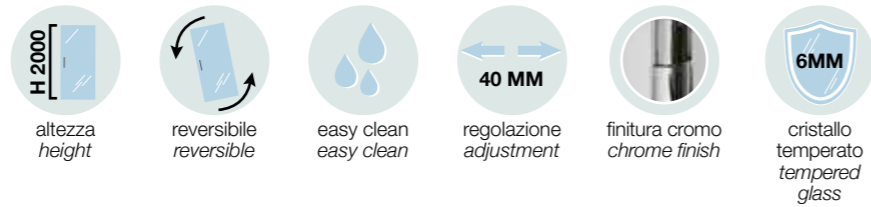

Cod. **NTPA01**
 Profilo di allungamento
 Adjustable profile
 + 30 mm
 € 47,00

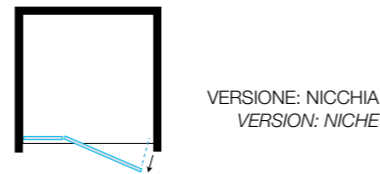

Lato porta battente / Hinge door side

Cod.	PD mm	mm	Apertura mm Opening mm	Profilo Profile	Kg	Cristallo trasparente Transparent glass 6 mm
TEPB04385010N	850	860 ↔ 900	550	NTCP03	31	€ 682,00
TEPB04385010NP	900	825 ↔ 850	550	NTCP01	34	€ 652,00
TEPB04390010NP	900	875 ↔ 900	600	NTCP03	40	€ 771,00
TEPB04390010N	950	910 ↔ 950	600	NTCP01	37	€ 701,00
TEPB04310010NP	1000	975 ↔ 1000	650	NTCP03	46	€ 683,00
TEPB04310010N	1050	1010 ↔ 1050	650	NTCP01	43	€ 712,00
TEPB04311010NP	1100	1075 ↔ 1100	650	NTCP03	31	€ 692,00
TEPB04311010N	1150	1110 ↔ 1150	650	NTCP01	49	€ 721,00
TEPB04312010NP	1200	1175 ↔ 1200	650	NTCP03	37	€ 700,00
TEPB04312010N	1250	1210 ↔ 1250	650	NTCP01	34	€ 729,00
TEPB04313010NP	1300	1275 ↔ 1300	650	NTCP03	43	€ 716,00
TEPB04313010N	1350	1310 ↔ 1350	650	NTCP01	40	€ 745,00
TEPB04314010NP	1400	1375 ↔ 1400	650	NTCP03	49	€ 731,00
TEPB04314010N	1450	1310 ↔ 1450	650	NTCP01	46	€ 760,00

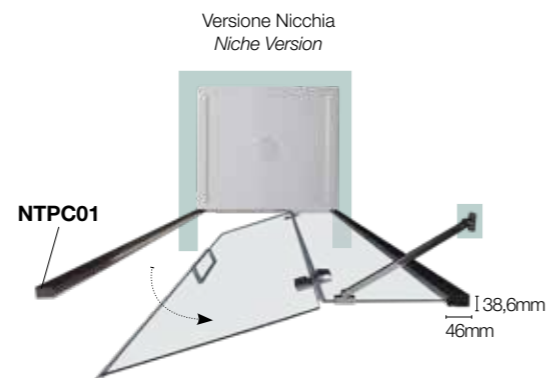
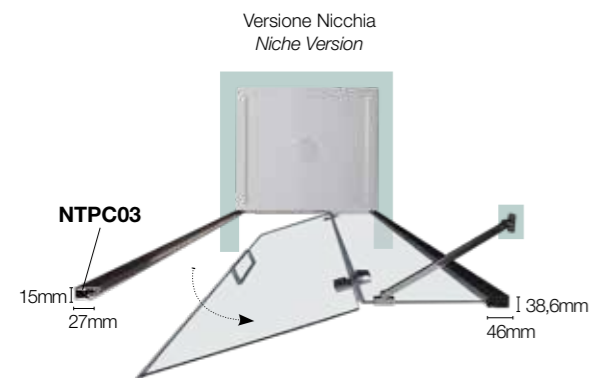

TEPB43 + TELF

Porta battente / Hinge door



Cod. **NTPA01**
 Profilo di allungamento
 Adjustable profile
 + 30 mm
 € 47,00

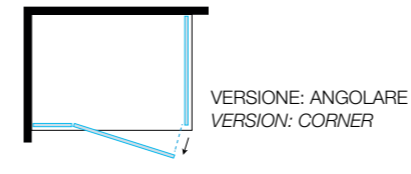

Lato porta battente / Hinge door side

Cod.	PD mm	mm	Apertura mm Opening mm	Kg	Cristallo trasparente Transparent glass 6 mm
TEPB04385010	850	820 ↔ 840	550	31	€ 599,00
TEPB04390010	900	870 ↔ 890	600	34	€ 619,00
TEPB04310010	1000	970 ↔ 990	650	37	€ 630,00
TEPB04311010	1100	1070 ↔ 1090	650	40	€ 639,00
TEPB04312010	1200	1170 ↔ 1190	650	43	€ 647,00
TEPB04313010	1300	1270 ↔ 1290	650	46	€ 663,00
TEPB04314010	1400	1370 ↔ 1390	650	49	€ 678,00

TELF - 2 Lato parete fissa / 2 Fixed side

TELF70	700	680 ↔ 700	25	€ 286,00
TELF80	800	770 ↔ 790	27	€ 294,00
TELF90	900	870 ↔ 890	29	€ 303,00
TELF100	1000	970 ↔ 990	31	€ 313,00

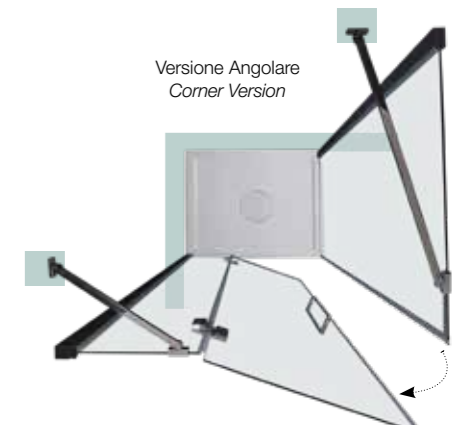

TB71

Porta battente / Hinge door



- altezza height
- reversibile reversible
- easy clean easy clean
- 10 MM regolazione adjustment
- finitura cromo chrome finish
- 6MM cristallo temperato tempered glass

Cod. **NTPA04**
 Profilo di allungamento
 Adjustable profile
 + 10 mm
 € 35,00

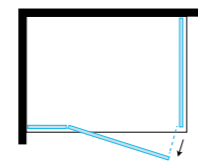

VERSIONE: ANGOLARE
 VERSION: CORNER

- altezza height
- reversibile reversible
- easy clean easy clean
- 10 MM regolazione adjustment
- finitura cromo chrome finish
- 6MM cristallo temperato tempered glass

Cod. **NTPA04**
 Profilo di allungamento
 Adjustable profile
 + 10 mm
 € 35,00

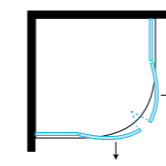

VERSIONE: SEMICIRCOLARE
 VERSION: SEMICIRCULAR

TB61

Porta battente / Hinge door



Box doccia angolare / Corner shower enclosure

Cod.	PD mm	mm	Apertura mm Opening mm	Kg	Cristallo trasparente Transparent glass 6 mm
TVB07172010	720 x 900	695 ↔ 705 x 875 ↔ 885	590	46	€ 596,00
TVB07171010	700 x 1000	675 ↔ 685 x 975 ↔ 985	640	49	€ 633,00
TVB07173010	700 x 1200	675 ↔ 685 x 1175 ↔ 1185	640	52	€ 662,00
TVB07181010	800 x 1000	775 ↔ 785 x 975 ↔ 985	640	51	€ 638,00
TVB07182010	800 x 1200	775 ↔ 785 x 1175 ↔ 1185	640	54	€ 670,00

Box doccia semicircolare / Semicircular shower enclosure

Cod.	PD mm	mm	Apertura mm Opening mm	Kg	Cristallo trasparente Transparent glass 6 mm
TVB06180010	800	775 ↔ 785	670	43	€ 638,00
TVB06190010	900	875 ↔ 885	670	50	€ 670,00
TVB06110010	1000	975 ↔ 985	670	56	€ 698,00

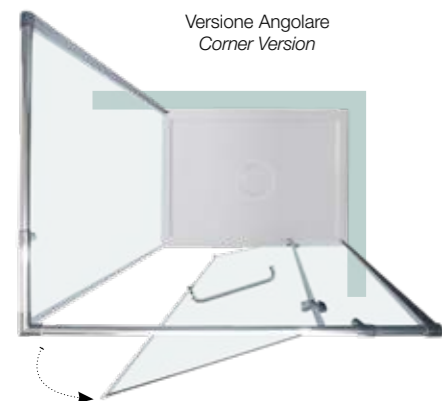

Versione Angolare
 Corner Version

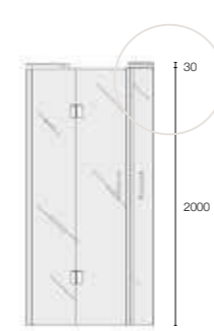
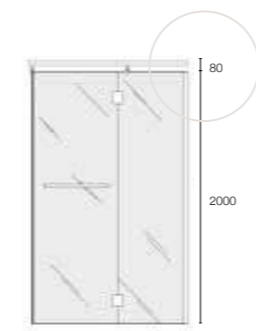

Versione Semicircolare
 Semicircular Version

RAGGIO
 RADIUS
 550

FPB40

Porta battente / Hinge door



- altezza height
- reversibile reversible
- easy clean easy clean
- 50 MM regolazione adjustment
- finitura cromo chrome finish
- 6MM cristallo temperato tempered glass

Cod. **TPAF08**
 Profilo di allungamento
 Adjustable profile
 + 30 mm
 € 47,00

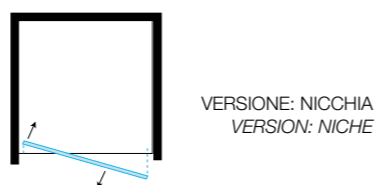

Box doccia completo / Complete shower enclosure

Cod.	PD mm	mm	Apertura mm Opening mm	Kg	Cristallo		
					trasparente Transparent glass 6 mm	satinato Frosted glass 6 mm	cincillà Cincillà glass 6 mm
FPB04070010	700	650 ↔ 700	510	25	€ 400,00	€ 448,00	€ 420,00
FPB04080010	800	750 ↔ 800	610	28	€ 406,00	€ 455,00	€ 426,00
FPB04090010	900	850 ↔ 900	710	31	€ 420,00	€ 471,00	€ 441,00



FPB40

Porta battente / Hinge door

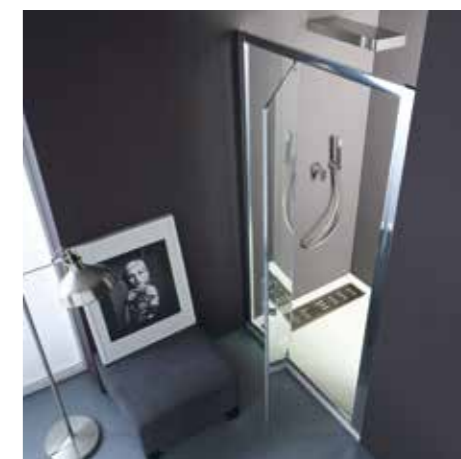

- altezza height
- reversibile reversible
- easy clean easy clean
- 50 MM regolazione adjustment
- finitura cromo chrome finish
- 6MM cristallo temperato tempered glass

Cod. **TPAF08**
 Profilo di allungamento
 Adjustable profile
 + 30 mm
 € 47,00

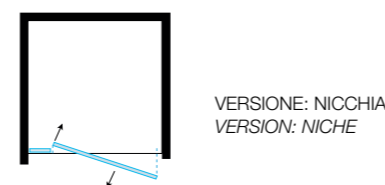

Box doccia completo / Complete shower enclosure

Cod.	PD mm	mm	Apertura mm Opening mm	Kg	Cristallo		
					trasparente Transparent glass 6 mm	satinato Frosted glass 6 mm	cincillà Cincillà glass 6 mm
FPB04010010	1000	950 ↔ 1000	516	34	€ 433,00	€ 485,00	€ 455,00
FPB04011010	1100	1050 ↔ 1100	516	36	€ 446,00	€ 501,00	€ 468,00
FPB04012010	1200	1150 ↔ 1200	516	40	€ 450,00	€ 504,00	€ 473,00

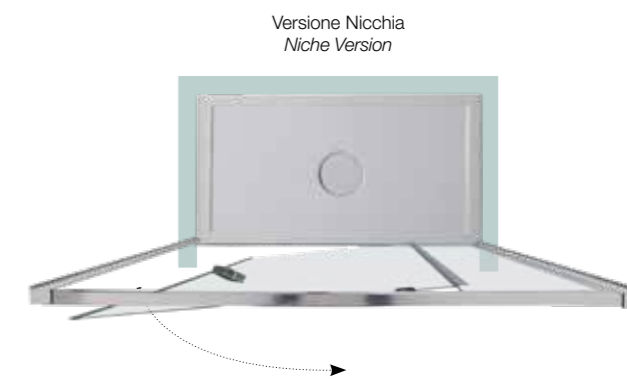

FPB40 + FISSO

Porta battente / Hinge door

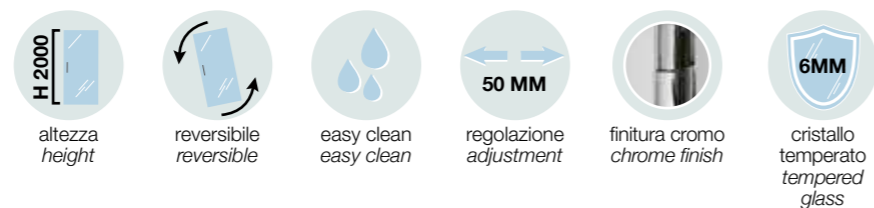

Cod. **TPAF08**
 Profilo di allungamento
 Adjustable profile
 + 25 mm
 € 47,00

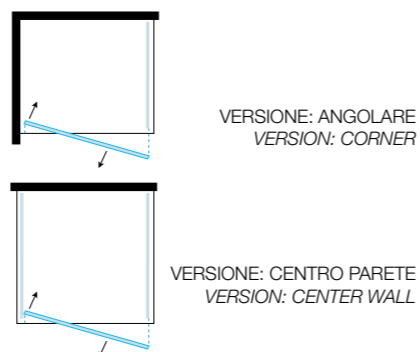

Lato porta battente / Hinge door side

Cod.	PD mm	mm	Apertura mm Opening mm	Kg	Cristallo		
					trasparente Transparent glass 6 mm	satinato Frosted glass 6 mm	cincillà Cincillà glass 6 mm
FPB04070010	700	662 ↔ 710	510	25	€ 400,00	€ 448,00	€ 420,00
FPB04080010	800	762 ↔ 810	610	28	€ 406,00	€ 455,00	€ 426,00
FPB04090010	900	862 ↔ 910	710	31	€ 420,00	€ 471,00	€ 441,00

FISSO - 2° e 3° Lato parete fissa / 2° and 3° Fixed side

FISSO70	700	665 ↔ 715	22	€ 295,00	€ 331,00	€ 310,00
FISSO80	800	765 ↔ 815	26	€ 301,00	€ 337,00	€ 316,00
FISSO90	900	865 ↔ 915	28	€ 310,00	€ 346,00	€ 326,00
FISSO100	1000	965 ↔ 1015	30	€ 317,00	€ 355,00	€ 334,00



FPB40 + FISSO

Porta battente / Hinge door



Cod. **TPAF08**
 Profilo di allungamento
 Adjustable profile
 + 25 mm
 € 47,00

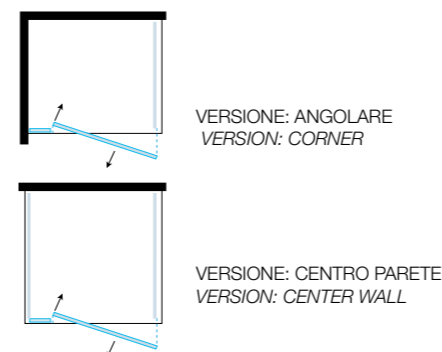

Lato porta battente / Hinge door side

Cod.	PD mm	mm	Apertura mm Opening mm	Kg	Cristallo		
					trasparente Transparent glass 6 mm	satinato Frosted glass 6 mm	cincillà Cincillà glass 6 mm
FPB04010010	1000	962 ↔ 1010	516	34	€ 433,00	€ 485,00	€ 455,00
FPB04011010	1100	1062 ↔ 1110	516	36	€ 446,00	€ 501,00	€ 468,00
FPB04012010	1200	1162 ↔ 1210	516	40	€ 450,00	€ 504,00	€ 473,00

FISSO - 2° e 3° Lato parete fissa / 2° and 3° Fixed side

FISSO70	700	665 ↔ 715	22	€ 295,00	€ 331,00	€ 310,00
FISSO80	800	765 ↔ 815	26	€ 301,00	€ 337,00	€ 316,00
FISSO90	900	865 ↔ 915	28	€ 310,00	€ 346,00	€ 326,00
FISSO100	1000	965 ↔ 1015	30	€ 317,00	€ 355,00	€ 334,00



TPS35

Porta a soffietto / Folding door

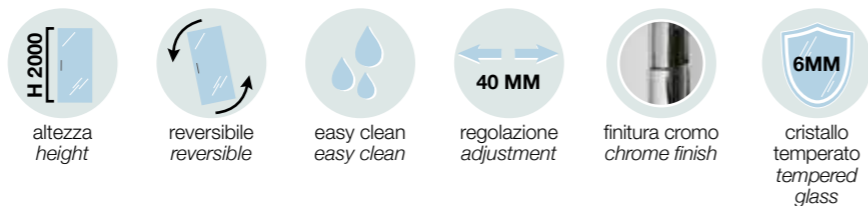

Cod. **NTPA01**
 Profilo di allungamento
 Adjustable profile
 + 30 mm
 € 47,00

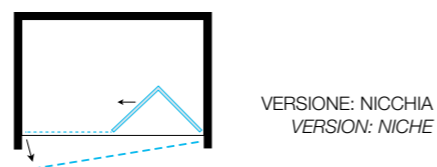

Box doccia completo / Complete shower enclosure

Cod.	PD mm	mm	Apertura mm Opening mm	Profilo Profile	Kg	Cristallo trasparente Transparent glass 6 mm
TPS03570010NP	700	685 ↔ 710	530	NTCP03	25	€ 524,00
TPS03570010N	750	720 ↔ 760	620	NTCP01	28	€ 553,00
TPS03580010NP	800	775 ↔ 800	720	NTCP03	31	€ 529,00
TPS03580010N	850	810 ↔ 850	820	NTCP01	34	€ 559,00
TPS03590010NP	900	870 ↔ 900	530	NTCP03	25	€ 540,00
TPS03590010N	950	910 ↔ 950	620	NTCP01	28	€ 569,00
TPS03510010NP	1000	975 ↔ 1000	720	NTCP03	31	€ 556,00
TPS03510010N	1050	1010 ↔ 1050	820	NTCP01	34	€ 585,00



Cristallo
 trasparente
 Transparent glass
 6 mm

TPS35 + TELF

Porta a soffietto / Folding door

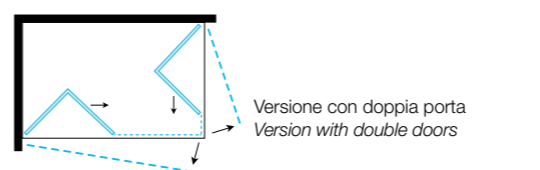
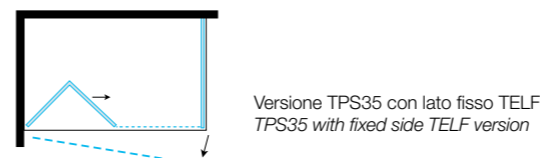

Cod. **TPA01**
 Profilo di allungamento
 Adjustable profile
 + 30 mm
 € 47,00

Lato porta a soffietto / Folding door side

Cod.	PD mm	mm	Apertura mm Opening mm PS35 + ELF	Kg	Cristallo trasparente Transparent glass 6 mm
TPS03570010	700	680 ↔ 700	530	25	€ 471,00
TPS03580010	800	770 ↔ 790	620	28	€ 476,00
TPS03590010	900	870 ↔ 890	720	31	€ 487,00
TPS03510010	1000	970 ↔ 990	820	34	€ 503,00



Cristallo
 trasparente
 Transparent glass
 6 mm

TELF - 2 Lato parete fissa / 2 Fixed side

TELF70	700	680 ↔ 700	25	€ 286,00
TELF80	800	770 ↔ 790	27	€ 294,00
TELF90	900	870 ↔ 890	29	€ 303,00
TELF100	1000	970 ↔ 990	31	€ 313,00

Versione Nicchia
 Niche Version

Versione Nicchia
 Niche Version

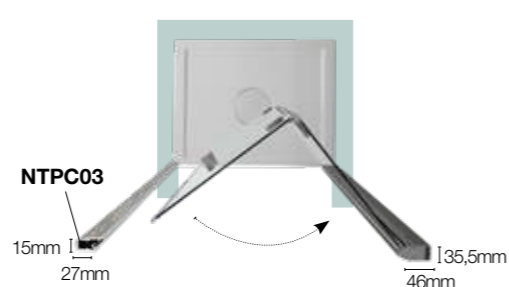
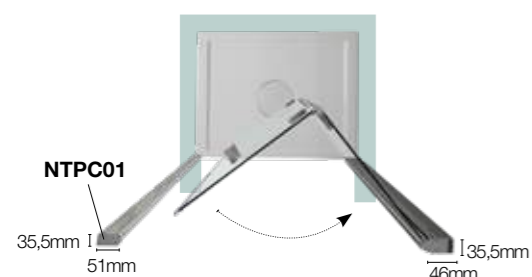

Versione con doppia porta
 Version with double doors

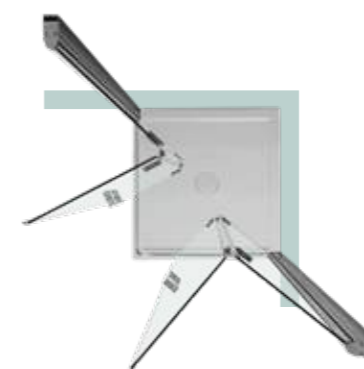

Versione TPS35 con lato fisso TELF
 TPS35 with fixed side TELF version

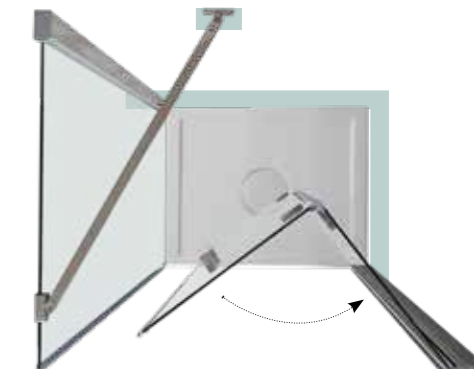

FPS30

Porta a soffietto / Folding door



- altezza
height
- reversibile
reversible
- easy clean
easy clean
- 50 MM
regolazione
adjustment
- finitura cromo
chrome finish
- 6MM
cristallo
temperato
tempered
glass

Cod. **TPAF08**
Profilo di allungamento
Adjustable profile
+ 30 mm
€ 47,00

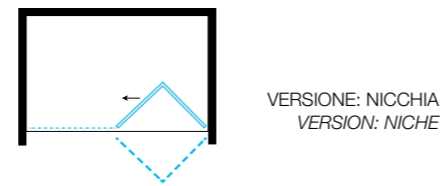

Box doccia completo / Complete shower enclosure

Cod.	PD mm	mm	Apertura mm Opening mm	Kg	Cristallo		
					trasparente Trasparent glass 6 mm	satinato Frosted glass 6 mm	cincillà Cincillà glass 6 mm
FPS03070010	700	650 ↔ 700	520	25	€ 458,00	€ 513,00	€ 481,00
FPS03080010	800	750 ↔ 800	620	28	€ 470,00	€ 526,00	€ 494,00
FPS03090010	900	850 ↔ 900	720	31	€ 477,00	€ 535,00	€ 501,00
FPS03010010	1000	950 ↔ 1000	800	34	€ 504,00	€ 565,00	€ 578,00



FPS30 + FISSO

Porta a soffietto / Folding door



- altezza
height
- reversibile
reversible
- easy clean
easy clean
- 50 MM
regolazione
adjustment
- finitura cromo
chrome finish
- 6MM
cristallo
temperato
tempered
glass

Cod. **TPAF08**
Profilo di allungamento
Adjustable profile
+ 30 mm
€ 47,00

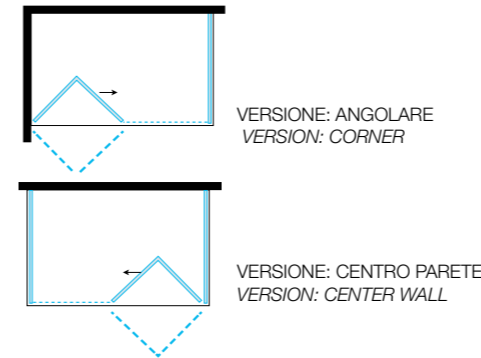

Lato porta a soffietto / Folding door side

Cod.	PD mm	mm	Apertura mm Opening mm	Kg	Cristallo		
					trasparente Trasparent glass 6 mm	satinato Frosted glass 6 mm	cincillà Cincillà glass 6 mm
FPS03070010	700	662 ↔ 710	520	25	€ 458,00	€ 513,00	€ 481,00
FPS03080010	800	762 ↔ 810	620	28	€ 470,00	€ 526,00	€ 494,00
FPS03090010	900	862 ↔ 910	720	31	€ 477,00	€ 535,00	€ 501,00
FPS03010010	1000	962 ↔ 1010	800	34	€ 504,00	€ 565,00	€ 578,00

FISSO - 2° e 3° Lato parete fissa / 2° and 3° Fixed side

FISSO70	700	685 ↔ 715	22	€ 295,00	€ 331,00	€ 310,00
FISSO80	800	765 ↔ 815	26	€ 301,00	€ 337,00	€ 316,00
FISSO90	900	865 ↔ 915	28	€ 310,00	€ 346,00	€ 326,00
FISSO100	1000	965 ↔ 1015	30	€ 317,00	€ 355,00	€ 334,00

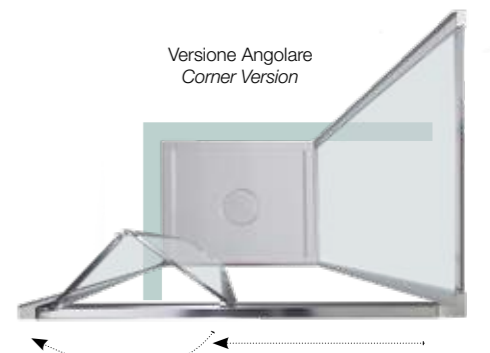

FPSL60

Porta a saloon / Saloon door

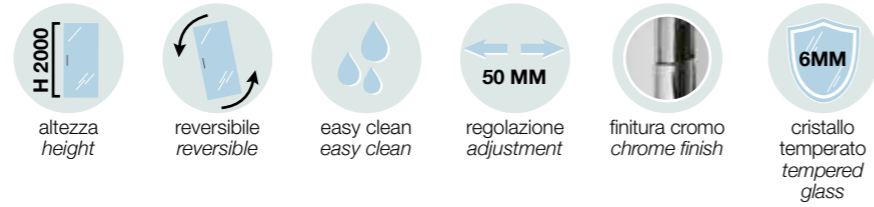

Cod. **TPAF08**
 Profilo di allungamento
 Adjustable profile
 + 30 mm
 € 47,00

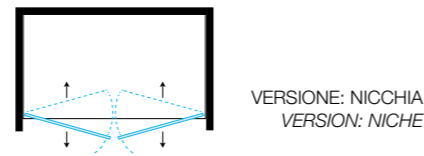

Box doccia completo / Complete shower enclosure

Cod.	PD mm	mm	Apertura mm Opening mm	Kg	Cristallo		
					trasparente Transparent glass 6 mm	satinato Frosted glass 6 mm	cincillà Cincillà glass 6 mm
FPSL06070010	700	650 ↔ 700	500	22	€ 462,00	€ 516,00	€ 485,00
FPSL06080010	800	750 ↔ 800	600	25	€ 473,00	€ 529,00	€ 497,00
FPSL06090010	900	850 ↔ 900	700	28	€ 486,00	€ 544,00	€ 510,00
FPSL06010010	1000	950 ↔ 1000	800	31	€ 501,00	€ 561,00	€ 526,00
FPSL06011010	1100	1050 ↔ 1100	900	34	€ 511,00	€ 572,00	€ 537,00
FPSL06012010	1200	1150 ↔ 1200	1000	37	€ 533,00	€ 596,00	€ 560,00

FPSL60 + FISSO

Porta a saloon / Saloon door



Cod. **TPAF08**
 Profilo di allungamento
 Adjustable profile
 + 30 mm
 € 47,00

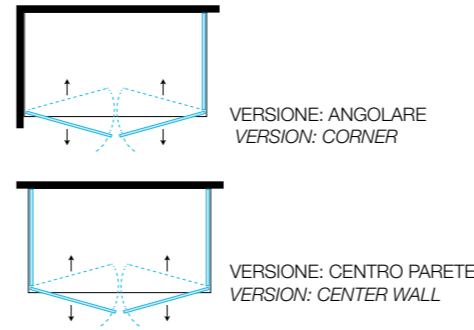

Lato porta a saloon / Saloon door side

Cod.	PD mm	mm	Apertura mm Opening mm	Kg	Cristallo		
					trasparente Transparent glass 6 mm	satinato Frosted glass 6 mm	cincillà Cincillà glass 6 mm
FPSL06070010	700	662 ↔ 710	500	22	€ 462,00	€ 516,00	€ 485,00
FPSL06080010	800	762 ↔ 810	600	25	€ 473,00	€ 529,00	€ 497,00
FPSL06090010	900	862 ↔ 910	700	28	€ 486,00	€ 544,00	€ 510,00
FPSL06010010	1000	962 ↔ 1010	800	31	€ 501,00	€ 561,00	€ 526,00
FPSL06011010	1100	1062 ↔ 1111	900	34	€ 511,00	€ 572,00	€ 537,00
FPSL06012010	1200	1162 ↔ 1210	1000	37	€ 533,00	€ 596,00	€ 560,00

FISSO - 2° e 3° Lato parete fissa / 2° and 3° Fixed side

FISSO70	700	665 ↔ 715	22	€ 295,00	€ 331,00	€ 310,00
FISSO80	800	765 ↔ 815	26	€ 301,00	€ 337,00	€ 316,00
FISSO90	900	865 ↔ 915	28	€ 310,00	€ 346,00	€ 326,00
FISSO100	1000	965 ↔ 1015	30	€ 317,00	€ 355,00	€ 334,00

Versione Nicchia
 Niche Version

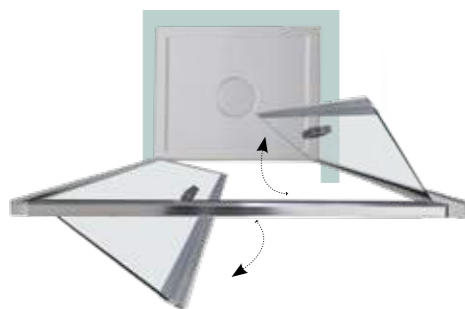

Versione Centro Parete
 Centre Wall Version



Versione Angolare
 Corner Version



6PAR53

Soluzioni aperte / Open solution

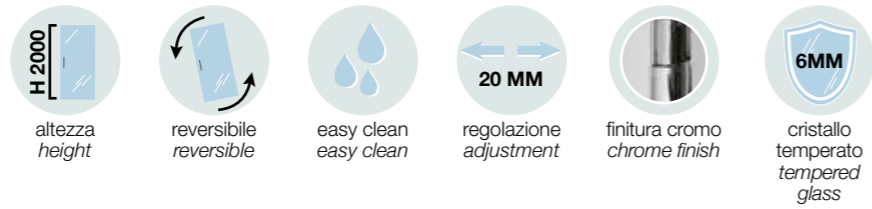

Cod. **NTPA05**
 Profilo di allungamento
 Adjustable profile
 + 25 mm
 € 47,00

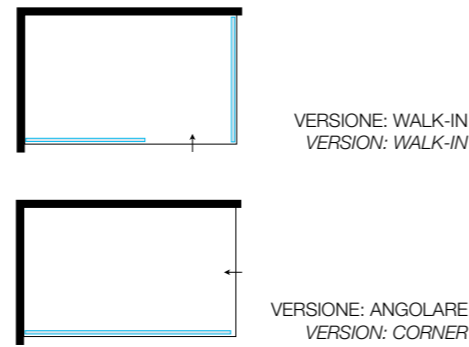

Singolo lato / Single side

Cod.	PD mm	mm	Kg	Cod. S Cristallo trasparente Transparent glass 6 mm	€
6PAR05370010	700	675 ↔ 695	30		€ 301,00
6PAR05380010	800	775 ↔ 795	32		€ 312,00
6PAR05390010	900	875 ↔ 895	34		€ 321,00
6PAR05310010	1000	975 ↔ 995	36		€ 346,00
6PAR05311010	1100	1075 ↔ 1095	38		€ 367,00
6PAR05312010	1200	1175 ↔ 1195	40		€ 376,00
6PAR05313010	1300	1275 ↔ 1295	42		€ 379,00
6PAR05314010	1400	1375 ↔ 1395	44		€ 396,00

Versione 6PAR53 da 1100 mm + lato 6PAR53 da 700 mm
 6PAR53 Version mm 1100 + side 6PAR53 mm 700

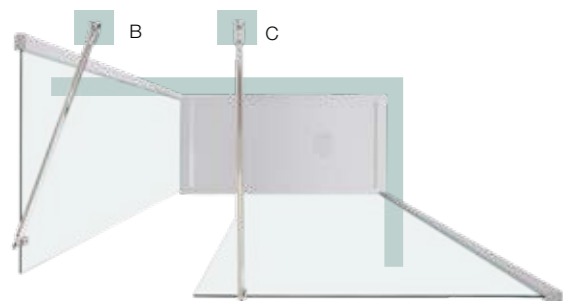

(B) L'estensibilità dell'asta di fissaggio varia da 500 mm fino a 800 mm
 (B) The extension of the support arm can vary from 500 mm to 800 mm

(C) L'estensibilità dell'asta di fissaggio varia da 710 mm fino a 1200 mm
 (C) The extension of the support arm can vary from 710 mm to 1200 mm

TSV51

Soprasvasca / Bathtub screen

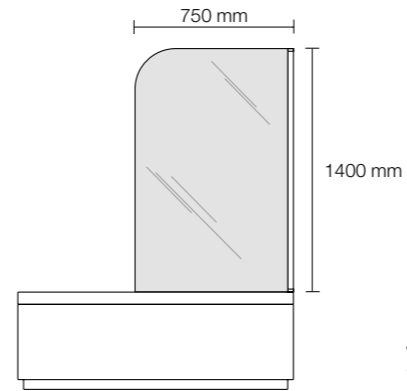

VERSIONE: 1 ANTA
 VERSION: 1 DOOR

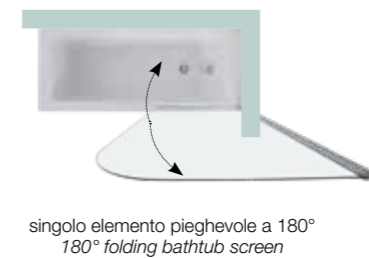

singolo elemento pieghevole a 180°
 180° folding bathtub screen



Soprasvasca 1 anta / 1 door bathtub screen

Cod.	mm	Kg	Cod. S Cristallo trasparente Transparent glass 5 mm	€
TSV5175010	750	15		€ 223,00

TSV52

Soprasvasca / Bathtub screen

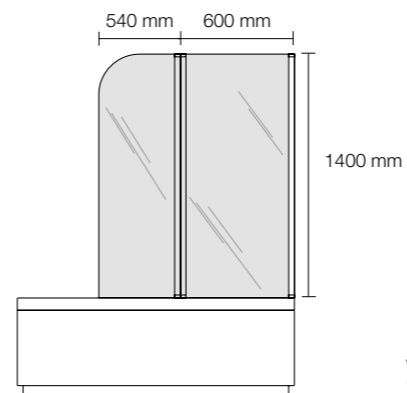

VERSIONE: 2 ANTE
 VERSION: 2 DOORS

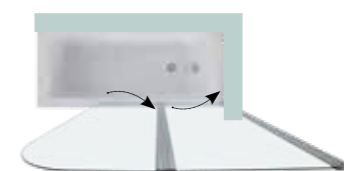

doppio elemento pieghevole a 180°
 180° double folding bathtub screen



Soprasvasca 2 ante / 2 doors bathtub screen

Cod.	mm	Kg	Cod. S Cristallo trasparente Transparent glass 5 mm	€
TSV5214010	1140	21		€ 315,00

LA GAMMA COMPLETA

THE COMPLETE RANGE

La colonna doccia è l'elemento ideale e indispensabile per una doccia-idromassaggio completa ed efficace. Il loro design particolarmente elegante ed essenziale è studiato per ottimizzare e valorizzare l'elemento acqua e l'ambiente in cui vengono inseriti. Tutti i modelli in base alle prestazioni sono muniti di una tecnologia idraulica all'avanguardia che permette di gestire, grazie a deviatori, i diversi tipi di getto azionabili singolarmente.

The shower column is the ideal and essential element for a complete and effective hydro-massage shower. Their particularly elegant and essential design was studied to optimize and give value to the water element and the environment where they are placed. All models, depending on their performance, are equipped with an avantgarde water technology, thanks to diverters, the different types of jets, can be activated individually or all together.

LOIRA 220x h 1600	pag. 156
SENNA 180x h 800	pag. 156
RIO 130-440x h 1120	pag. 157
LENA 180x h 1600	pag. 157
DANUBIO 130x h 1600	pag. 158
NILO 130-440x h 1120	pag. 158
VOLGA 130x h 1300	pag. 159
PO 100x70x h 2100	pag. 159
X1 250x h 1000 / 1030	pag. 160
X3 150x h 1070	pag. 161

**INDICE COLLEZIONI
COLONNE DOCCIA**
INDEX COLLECTIONS
SHOWER COLUMNS



LOIRA

Colonna doccia / Shower column



1. SOFFIONE DOCCIA INTEGRATO
HEAD SHOWER
2. IDROGETTI
JETS
3. DEVIATORE
DIVERTER
4. MISCELATORE MECCANICO
MECHANICAL MIXER
5. DOCCETTA
HAND SHOWER
6. PORTASHAMPOO
SHAMPOO SHELF
7. DISPENSER SAPONE
SOAP DISPENSER
8. ATTACCHI ACQUA CALDA E FREDDA
HOT AND COLD WATER CONNECTIONS

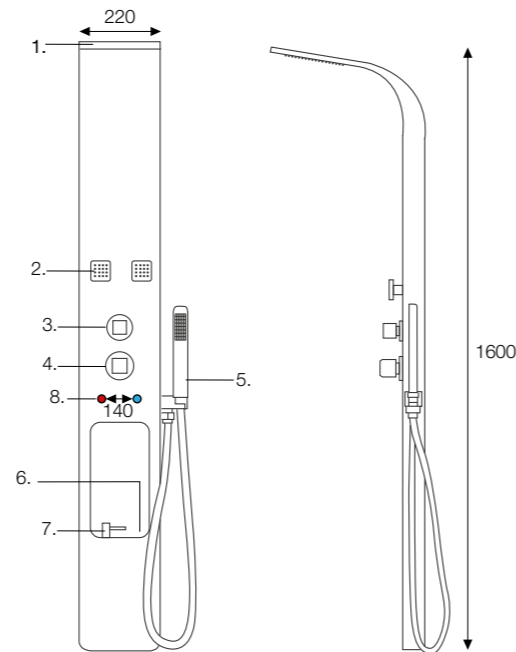

ALLUMINIO
Finitura bianca

ALLUMINIO
Finitura silver

ALLUMINIUM
White finish

ALLUMINIUM
Silver finish

Cod.	Finitura colonna Column finish	Prezzo Price
CD700160BI	Bianca / White	€ 776,00
CD700161SI	Silver	€ 776,00

RIO

Colonna doccia / Shower column



1. SOFFIONE DOCCIA INTEGRATO
HEAD SHOWER
2. MISCELATORE MECCANICO
MECHANICAL MIXER
3. PORTASHAMPOO
SHAMPOO SHELF
4. DEVIATORE
DIVERTER
5. DOCCETTA A DUE VIE
HAND SHOWER WITH DIVERTER
6. ATTACCHI ACQUA CALDA E FREDDA
HOT AND COLD WATER CONNECTIONS

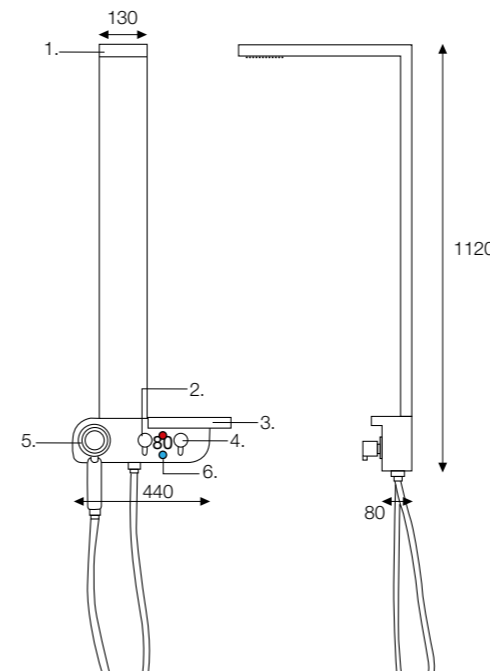

Cod.	Finitura colonna Column finish	Prezzo Price
CD700154AL	Specchiata / Mirrored	€ 560,00
CD700161SI	Spazzolato / Brushed	€ 545,00

ACCIAIO
Finitura specchiata

ACCIAIO
Spazzolato

STAIN STEEL
Mirrored finish

STAIN STEEL
Brushed finish

SENNA

Colonna doccia / Shower column



1. SOFFIONE DOCCIA INTEGRATO
HEAD SHOWER
2. LAMA D'ACQUA A CASCATA
WATER FALL SHOWER
3. DEVIATORE
DIVERTER
4. MISCELATORE MECCANICO
MECHANICAL MIXER
5. DOCCETTA
HAND SHOWER
6. ATTACCHI ACQUA CALDA E FREDDA
HOT AND COLD WATER CONNECTIONS

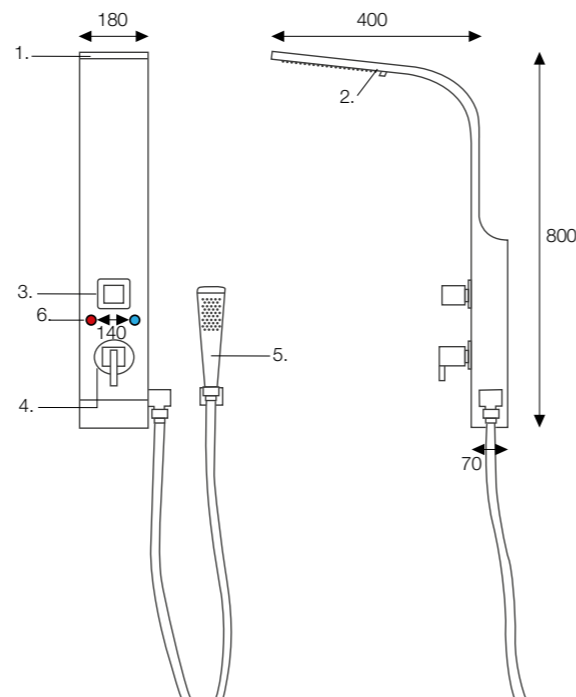

ACCIAIO
Finitura bianca

ACCIAIO
Finitura silver

STAIN STEEL
White finish

STAIN STEEL
Silver finish

Cod.	Finitura colonna Column finish	Prezzo Price
CD700158BI	Bianca / White	€ 545,00
CD700159SI	Silver	€ 526,00

LENA

Colonna doccia / Shower column



1. SOFFIONE DOCCIA INTEGRATO
HEAD SHOWER
2. IDROGETTI
JETS
3. DEVIATORE
DIVERTER
4. MISCELATORE MECCANICO
MECHANICAL MIXER
5. DOCCETTA A DUE VIE
HAND SHOWER WITH DIVERTER
6. ATTACCHI ACQUA CALDA E FREDDA
HOT AND COLD WATER CONNECTIONS

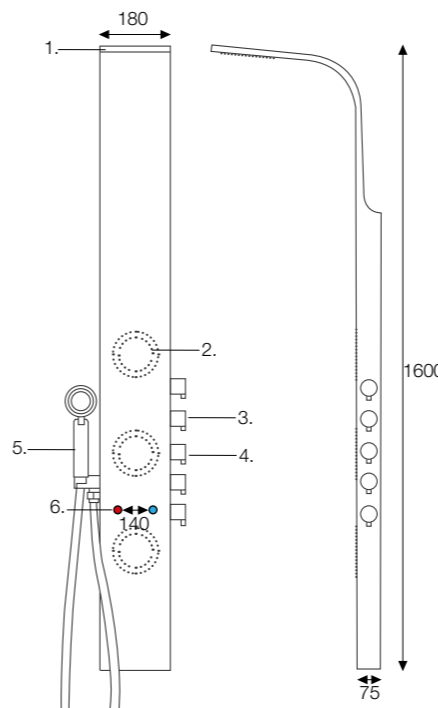

Cod.	Finitura colonna Column finish	Prezzo Price
CD700164BI	Bianca / White	€ 762,00
CD700165SI	Silver	€ 725,00

ACCIAIO
Finitura bianca

ACCIAIO
Finitura silver

STAIN STEEL
White finish

STAIN STEEL
Silver finish

DANUBIO

Colonna doccia / Shower column



ACCIAIO
Finitura specchiata

ACCIAIO
Spazzolato

STAIN STEEL
Mirrored finish

STAIN STEEL
Brushed finish

1. SOFFIONE DOCCIA INTEGRATO
HEAD SHOWER
2. DEVIATORE
DIVERTER
3. IDROGETTI
JETS
4. DOCCETTA
HAND SHOWER
5. MISCELATORE MECCANICO
MECHANICAL MIXER
6. ATTACCHI ACQUA CALDA E FREDDA
HOT AND COLD WATER CONNECTIONS

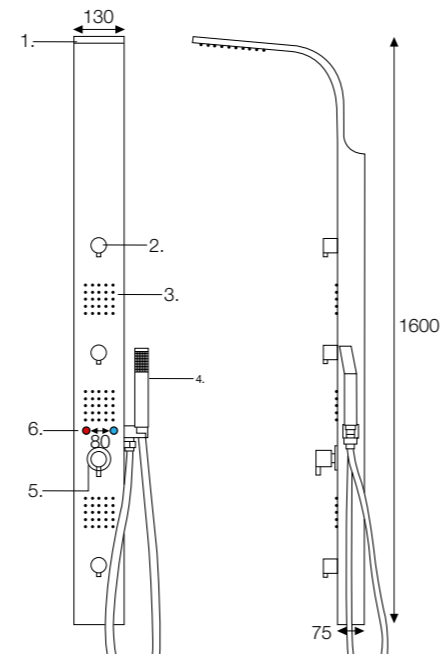

Cod.	Finitura colonna Column finish	Prezzo Price
CD700162AL	Specchiata / Mirrored	€ 738,00
CD700163AS	Spazzolato / Brushed	€ 715,00

VOLGA

Colonna doccia / Shower column



ACCIAIO
Finitura bianca

ACCIAIO
Finitura nera

STAIN STEEL
White finish

STAIN STEEL
Black finish

1. SOFFIONE DOCCIA INTEGRATO
HEAD SHOWER
2. DEVIATORE
DIVERTER
3. MISCELATORE MECCANICO
MECHANICAL MIXER
4. DOCCETTA
HAND SHOWER
5. IDROGETTI
JETS
6. ATTACCHI ACQUA CALDA E FREDDA
HOT AND COLD WATER CONNECTIONS

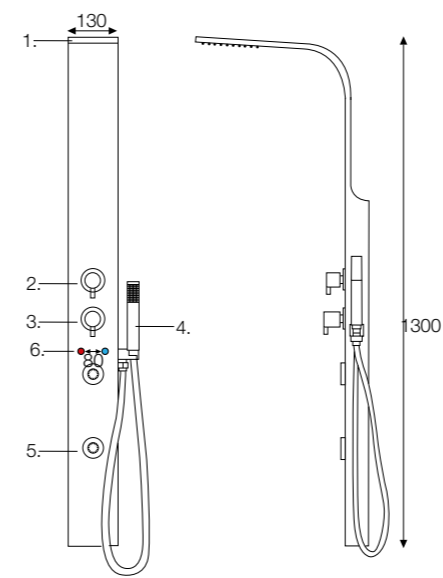

Cod.	Finitura colonna Column finish	Prezzo Price
CD700156BI	Bianca / White	€ 653,00
CD700157NE	Nera / Black	€ 653,00

NILO

Colonna doccia / Shower column



ACCIAIO
Finitura bianca

STAIN STEEL
White finish

ACCIAIO
Finitura nera

STAIN STEEL
Black finish

1. SOFFIONE DOCCIA INTEGRATO
HEAD SHOWER
2. DEVIATORE
DIVERTER
3. PORTASHAMPOO
SHAMPOO SHELF
4. MISCELATORE MECCANICO
MECHANICAL MIXER
5. DOCCETTA A DUE VIE
HAND SHOWER WITH DIVERTER
6. ATTACCHI ACQUA CALDA E FREDDA
HOT AND COLD WATER CONNECTIONS

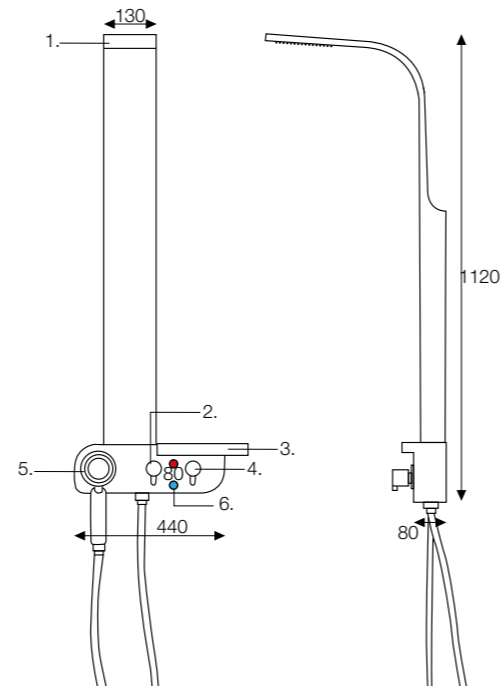

Cod.	Finitura colonna Column finish	Prezzo Price
CD700167BI	Bianca / White	€ 475,00
CD700168NE	Nera / Black	€ 475,00

PO

Colonna doccia / Shower column



ACCIAIO
Finitura Spazzolato
antimpronta

STAIN STEEL
Brushed
fingerprint proof finish

1. SOFFIONE DOCCIA INTEGRATO
HEAD SHOWER
2. DEVIATORE
DIVERTER
3. TRATTAMENTO ANTIMPRONTA
FINGERPRINT PROOF FINISH
4. LAVAPIEDI
FOOTWASHER

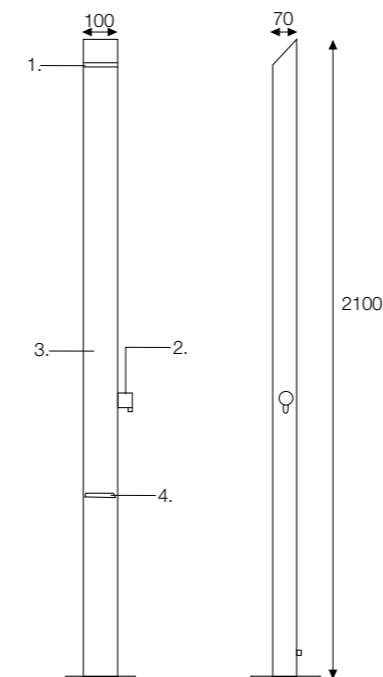

Cod.	Finitura colonna Column finish	Prezzo Price
CD700166A	Spazzolato / Brushed	€ 629,00

X1

Colonna doccia / Shower column

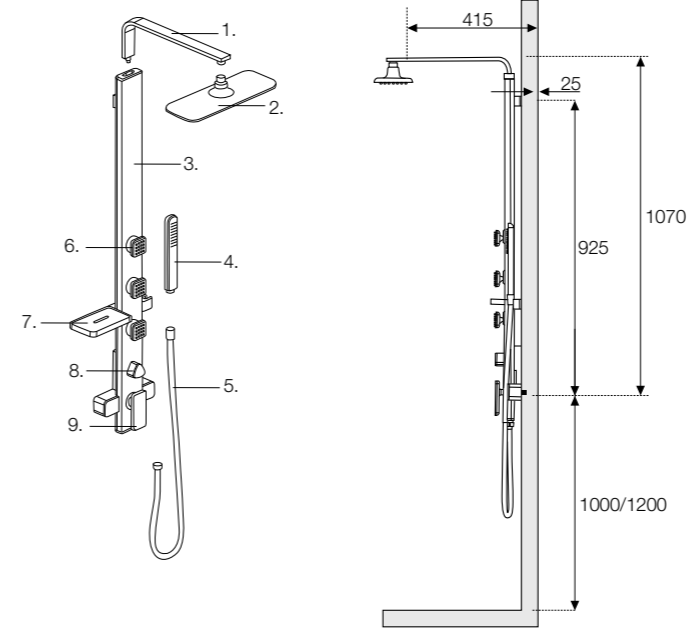
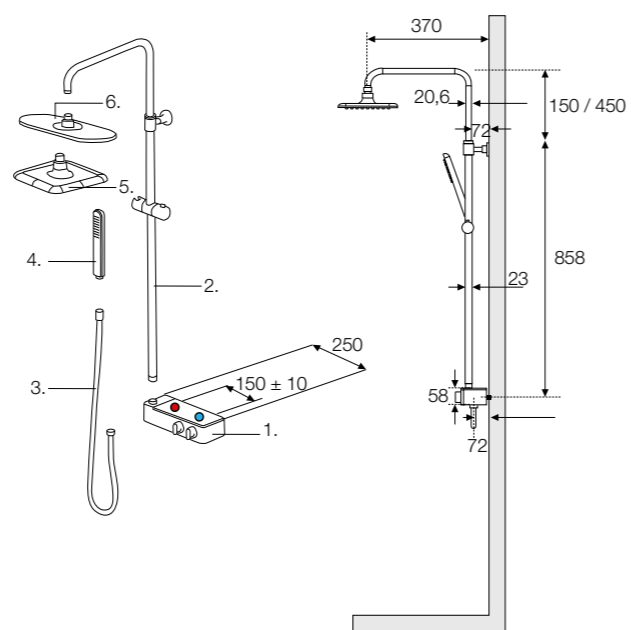

Colonna doccia / Shower column

X3



ACCIAIO
Finitura bianca

ACCIAIO
Finitura bianca

STAIN STEEL
White finish

STAIN STEEL
White finish

1. CORPO RUBINETTERIA
FAUCET BODY
2. TUBO ACCIAIO INOX
STAINLESS STEEL HOSE
3. FLESSIBILE DOCCINO
HAND SHOWER FLEXIBLE HOSE
4. DOCCETTA A MANO
HAND SHOWER
5. SOFFIONE DOCCIA QUADRATO
SQUARE SHOWER HEAD
6. SOFFIONE DOCCIA OVALE
OVAL SHOWER HEAD

1. TUBO CURVO
BEND PIPE
2. SOFFIONE DOCCIA
SHOWER HEAD
3. CORPO DOCCIA
SHOWER UNITS
4. DOCCETTA A MANO
HAND SHOWER
5. FLESSIBILE DOCCINO
HAND SHOWER FLEXIBLE HOSE
6. GETTI ORIENTABILI
ADJUSTABLE JETS
7. PORTASAPONE
SOAPHOLDET
8. DEVIATORE
DIVERTER
9. MONOCOMANDO
LEVER

ACCIAIO
Finitura
specchiata

STAIN STEEL
Mirrored finish

ACCIAIO
Finitura bianca

STAIN STEEL
White finish



Cod.	Finitura colonna Column finish	Prezzo Price
CD700153SO	Bianca soffione ovale / White oval shower head	€ 380,00
CD700152SQ	Bianca soffione quadrato / White square shower head	€ 380,00

Cod.	Finitura colonna Column finish	Prezzo Price
CD700151AL	Specchiata / Mirrored	€ 644,00
CD700150BI	Bianca / White	€ 644,00



ACCESSORI BOX DOCCIA

SHOWER ENCLOSURE ACCESSORIES



MANIGLIE

HANDLES

Cod.	mm	Per art. For art.	Cromo Chrome
M1	145	PSC50 - PSL60 - PB40 - S40 - S50 - S70	€ 13,00
M2	145	PSC50 - PSL60 - PB40 - S40 - S50 - S70	€ 13,00
M3		PB20	€ 9,50
M4	182	PSC55	€ 13,00
M5	380	EPB42 - EPB43 - PSC15 - 8PSC15	€ 56,00
M6	130	B61	€ 17,00
M7	475	B71	€ 25,00
M8	191	PB72 - PS35 - 8MILL INFINITY	€ 25,00

CERNIERE

HINGES



Cod.	Per art. For art.	Cromo Chrome
C1	PB40	€ 16,00



C2	B61-B71	€ 55,00
----	---------	---------



C3	EPB43	€ 84,00
----	-------	---------



C4	PB10	€ 50,00
----	------	---------



C5	PB72	€ 78,00
----	------	---------



C6	PS35	€ 46,00
----	------	---------



C7	8MILL INFINITY	€ 80,00
----	----------------	---------



SEZIONE
SECTION



SEZIONE
SECTION



SEZIONE
SECTION



SEZIONE
SECTION



SEZIONE
SECTION



SEZIONE
SECTION



GUARNIZIONI

GASKETS

Guarnizioni sotto porta / Under door gaskets

Cod.	Per art. For art.	Prezzo Price
G1	B61 - B71 - PB10 - PB40 - PSL60 - EPB42 - EPB43 - PS35	€ 8,00
8G1	8MILL INFINITY	€ 10,00

Guarnizioni laterale per porta / Door gaskets

G2	B61-B71--PB40--EPB43	€ 12,00
8G2	8MILL INFINITY	€ 13,00

Guarnizioni laterale per porta / Door gaskets

G3	S40 - S50 - S70 - PSC50 - PSC55 - PSC15	€ 12,00
8G3	8PSC15	€ 13,00

Guarnizioni calamitata per porta / Magnetic door gaskets

G4	S40 - S50 - S70 - PSL60 - EPB42 - EPB43 - B61 - B71	€ 31,00
8G4	8MILL INFINITY	€ 34,00

Guarnizioni calamitata per porta / Magnetic door gaskets

G5	PSC55 - PSC15 - PSC50	€ 33,00
8G5	8PSC15	€ 36,00

Guarnizioni centrale per porta / Central door gaskets

G6	PS35	€ 9,00
----	------	--------

Guarnizioni calamitata per vetro fisso / Magnetic fixed glass gaskets

G7	PSC15	€ 14,00
----	-------	---------

Guarnizioni sotto porta / Under door gaskets

G8	PS30	€ 7,50
----	------	--------

SNODI, ANGOLI DI SCORRIMENTO

PIVOTS, CORNERS AND SLIDING SYSTEM



Snodo per sopra vasca / Pivot for bathtub panel

Cod.	Per art. For art.	Cromo Chrome
SSV	SV052 - SV051	€ 8,50



Snodo per la porta / Pivot for door

SPC	PS30	€ 7,50
-----	------	--------



Snodo per sopra vasca / Pivot for bathtub panel

SV	SV052	€ 8,50
----	-------	--------



Angolo di giunzione per box doccia / Corner connection for shower enclosure

AG	S50 - S70	€ 6,00
----	-----------	--------



Superiore
Superior



Inferiore
Inferior

Gruppo di scorrimento con sgancio rapido per le porte scorrevoli / Sliding mechanism with quick release for the sliding doors

GSSUP	S50 - S70 - PSC50 - S40 72x90 - S40 80x100 - S40 80x120	€ 11,00
GSSINF	S50 - S70 - PSC50 - S40 72x90 - S40 80x100 - S40 80x120	€ 11,00



Superiore
Superior



Inferiore
Inferior

Gruppo di scorrimento con sgancio rapido per le porte scorrevoli / Sliding mechanism with quick release for the sliding doors

GSS40SUP	S40 80x80 - S40 90x90	€ 9,00
GSS40 INF	S40 80x80 - S40 90x90	€ 9,00



Superiore
Superior

Gruppo di scorrimento per porte scorrevoli / Sliding mechanism for the sliding doors

GSPSC15	PSC15 - 8PSC15	€ 27,00
---------	----------------	---------



Cod.	mm	Per art. For art.	Cromo Chrome
AF01	500 ↔ 800	PAR53 - 8PAR53	€ 45,00



Cod.	mm	Per art. For art.	Cromo Chrome
AF02	710 ↔ 1200	PAR53 - 8PAR53 - 8PAR54	€ 56,00



Cod.	Lunghezza Length mm	Per art. For art.	Cromo Chrome
AF0329	295	ELF - PB43	€ 36,00
AF0336	365	ELF - PB43	€ 39,00
AF0347	475	ELF - PB43	€ 49,00
AF03600	575	ELF - PB43	€ 56,00
AF0365	650	ELF - PB43	€ 60,00



Profilo allungamento
Adjustable profile

Cod.	Estensibilità Extension	Per art. For art.	Cromo Chrome
NTPA01	+30 mm	EPB042 - EPB043 - ELF - PS35	€ 47,00



Profilo allungamento
Adjustable profile

NTPA08	+25 mm	FPB40 - FPSC50 - FPS30 - PFSL60 - FISSO - FPSC57	€ 47,00
--------	--------	--	---------



Profilo allungamento
Adjustable profile

NTPA04	+10 mm	TB61 - TB71	€ 35,00
--------	--------	-------------	---------



Profilo allungamento
Adjustable profile

NTPA05	+25 mm	TPB72 - TBLF - 6PAR53 - 8PAR53	€ 47,00
--------	--------	--------------------------------	---------

ASTE DI FISSAGGIO

SUPPORT ARM

PROFILI

PROFILES

PROFILI

PROFILES



Profilo allungamento
Adjustable profile

Cod.	Estensibilità Extension	Per art. For art.	Cromo Chrome
NTPA06	+15 mm	6PSC15 - 8PSC15	€ 36,00



Profilo allungamento
Adjustable profile

NTPA07	+20 mm	8MILL INFINITY	€ 47,00
--------	--------	----------------	---------



Profilo chiusura
Closing profile

NTPC01		TEPB42 - TEPB43 - TPS35	€ 83,00
--------	--	-------------------------	---------



Profilo chiusura
Closing profile

NTPC02		6PSC15 - 8PSC15	€ 100,00
--------	--	-----------------	----------



Profilo chiusura
Closing profile

8TPC03		8MILL INFINITY	€ 67,00
--------	--	----------------	---------



Profilo chiusura
Closing profile

NTPC03		TEPB42 - TEPB43 - TPS35 - TPB72	€ 53,00
--------	--	---------------------------------	---------

TEST ACQUA

WATER TEST

La tenuta dell'acqua dei box doccia NON va verificata puntando il getto d'acqua direttamente sul vetro.
Un'installazione a regola d'arte del prodotto ne consente un normale utilizzo senza che l'acqua fuoriesca.

*It is NOT possible to verify the water proof of the shower enclosure by pointing the water from the hand shower directly on the glass.
A correct installation of the product allows no water to exit during normal use.*



CONDIZIONI DI VENDITA

EVASIONE ORDINI

Gli ordini rappresentano l'impegno del Committente all'acquisto, mentre divengono definitivi solo dopo esplicita accettazione della Tamanaco oppure, nel caso di assenza di accettazione esplicita, dopo un periodo di 15 giorni dal ricevimento in sede dell'ordine medesimo. Gli ordini possono essere evasi anche parzialmente ed in più riprese.

ANNULLAMENTO ORDINI

Nessun annullamento ordini verrà accettato senza la preventiva ed esplicita autorizzazione della Tamanaco, che si riserva comunque la facoltà di addebitare eventuali spese ed oneri conseguiti.

TEMPI DI CONSEGNA

I tempi di consegna sono puramente indicativi e non saranno ammessi in nessun caso come motivo di annullamento totale o parziale dell'ordine, né per richieste di risarcimento ad alcun titolo. Nel caso in cui il termine di consegna sia essenziale per l'acquirente, andrà specificatamente segnalato per iscritto al momento dell'ordine.

PREZZI E PAGAMENTI

I prezzi di vendita applicati corrispondono a quelli riportati sul listino ufficiale alla data della stipulazione dell'ordine. La Tamanaco si riserva la facoltà di effettuare variazioni di tali prezzi anche senza preavviso. Gli ordini già in essere e con una programmazione di consegna oltre i 60 gg dalla data di entrata in vigore dei nuovi listini, verranno assoggettati al nuovo regime di prezzi.

Le condizioni di pagamento sono quelle pattuite specificatamente per ogni cliente. In caso di clienti nuovi, o di variazioni delle condizioni stesse, tali andranno espressamente dichiarate al momento dell'ordine e successivamente approvate dalla Tamanaco. In caso di ritardato pagamento, verranno addebitati gli interessi di legge.

La merce venduta rimarrà di proprietà esclusiva della Tamanaco fino al completo pagamento della stessa.

IMBALLO

Il prezzo pattuito per i prodotti Tamanaco è comprensivo di normale imballo. Nel caso di particolari esigenze di trasporto e quindi di imballo, potrà essere addebitata una maggiorazione in funzione del costo aggiuntivo sopportato.

TRASPORTO

Ai sensi dell'art. 150 del Codice Civile, merce viaggia a rischio e pericolo del Committente, anche là dove il prezzo della stessa si intenda franco destino. Le contestazioni per materiale danneggiato dovranno pervenire entro e non oltre 8gg dalla consegna.

GARANZIA

La merce si intende coperta dalla garanzia secondo quanto previsto dal Codice Civile Italiano e dalla normativa europea in materia. Tale garanzia è valida per ventiquattro mesi dalla data d'acquisto comprovata dal documento fiscale d'acquisto. La garanzia non copre i danni derivanti da eventi naturali eccezionali, né da prodotti chimici presenti nelle condutture dell'acqua né quelli derivanti da cattivo uso o errata manutenzione dell'apparecchiatura. La garanzia include la sostituzione gratuita dei componenti e delle parti che risultano mal funzionanti nei primi due anni di vita del prodotto e la riproduzione a totale carico del produttore. La garanzia non copre la sostituzione di parti soggette a normale usura.

RESI DI MERCE

L'eventuale reso di prodotti Tamanaco dovrà essere sempre effettuato dopo specifica autorizzazione, da richiedere caso per caso. Rimanendo comunque a carico del committente aggravati per spese generali di ripristino e di re immagazzinaggio, oltre ad eventuali altre spese dovute a rotture od incuria del cliente.

CONTROVERSIE LEGALI

Le condizioni suddette vengono integralmente accettate dal Committente al momento del conferimento alla Tamanaco.

Per ogni controversia in merito, l'unico Foro competente è quello di Viterbo.

In caso di fuori squadra dei muri o del piatto, ondulazioni degli stessi, la Tamanaco declina ogni responsabilità per eventuali difficoltà o impossibilità di installazione del prodotto, così come non risponderà per eventuali perdite di acqua o malfunzionamenti vari.

La COLACRIL si riserva di apportare modifiche parziali o radicali ai prodotti, nonché di deciderne l'eliminazione dal catalogo anche senza preavviso. Gli allestimenti e le tonalità di colori delle fotografie sono puramente indicativi.

GENERAL SALES CONDITIONS

ORDERS

The orders represent a commitment of the customer to purchase. The acceptance of order is subject to explicit approval by Tamanaco, otherwise, in the absence of explicit approval, the order will be considered valid only after 15 days from receiving the same order in the head office. Tamanaco may also execute partial orders and make more than one delivery.

ORDER CANCELLATION

Possible request of order cancellation does not automatically imply its acceptance, without the explicit authorization by Tamanaco. The manufacturer will inform the customer in writing of eventual charges deriving from the request.

DELIVERY TIME

The delivery time is intended as a non-binding approximate date of reference and will be not admitted as reason for total or partial order cancellation, neither for compensation for damages. In case of request of different delivery, the customer must specifically indicate in writing on the order.

PRICES AND PAYMENT

The prices correspond to those reported on the official pricelist at the date of the order. Tamanaco reserves the right to make changes in these prices without notice.

Orders already in place and schedule of delivery more than 60 days from the date of those in force of the new price lists, will be subject to the new price. Payment terms are those specifically agreed for each customer. In case of new customers, or changes in conditions, these will be explicitly declared at time of order and subsequently approved by Tamanaco. Non observance of the agreed payment terms and deadlines shall entail the charging, by Tamanaco of interest at the current bank rates. The goods shall remain the property of TAMANACO until they have been paid for completely.

PACKAGING

Prices include normal packaging. Where loading on special packaging is needed, relative costs will be invoiced.

TRANSPORT

The transport of goods are always at buyer's own risk and danger according to art. 150 Civil Code, including cases of carriage-free delivery. Any claims should be made directly to our company and never later than eight days after receipt of goods.

WARRANTY

Tamanaco guarantees its products for twenty-four months starting from the purchase date shown on the bill of sale, according to the Italian Civil Code and the ECC rules. This guarantee will cover none of the damages caused by extraordinary natural events or by chemical products through the water pipe and damages resulting from misuse or unsuitable servicing of appliance. The warranty will include the free replacement of parts and components which prove to be defective during the first two-years of service. The freight for repairing the product is at charge of the producer. The warranty will not cover the replacement of parts due to normal wear and tear.

RETURNS

Returns of material for any reason must be authorised by Tamanaco. Costs of any nature borne for the replacement of materials shall always be debited exclusively to the customer as well as charges about damages caused by improper use or customer's negligence.

CONTROVERSY

That stated above is considered as accepted in full with the transmission of the order.

Viterbo Law Court is the sole competent for any dispute between Tamanaco sas and their customer.

TAMANACO'S liability for damage caused to the customer is governed by disposition of the regulations in force.

In the case of imperfection of wall or floor, Tamanaco disclaims any responsibility for any difficulty or impossibility to install the product as well as it is not responsible for malfunction of the product.

COLACRIL reserves the right of changing data and characteristics of its products without notice, models may be charged or cancelled at any time. The photographs featured in the catalogue shall not be considered binding the are merely indicative and for indication purposes only.

Colacril si riserva il diritto di apportare eventuali modifiche ai prodotti senza obbligo di preavviso o di sostituzione delle caratteristiche presenti a catalogo.

Colacril reserves the right to carry out modifications of the catalog products without prior notice.

contatti/*contacts*:

 +39 0761 595595

 +39 0761 517595

 colacril@colacril.it

 www.colacril.it

Ufficio commerciale Italia: ● ordini@colacril.it
Commercial office Italy

Ufficio commerciale Estero: ● sales@colacril.it
Export office

Ufficio post-vendita: ● tecnico@colacril.it
Post-sales office

Colacril

ACQUA BENESSERE
by

Tamanaco srl

 Sede operativa: Via Delle Industrie, 1 - 01033 Civita Castellana VT - Italy
Sede legale: Via Gargarasi, 1 - 01033 Civita Castellana VT - Italy

WWW.COLACRIL.IT

Colacril
ACQUA BENESSERE